



BUREAU VERITAS

Test Report No.: RE2312WDG0148-2



TEST REPORT

Applicant	Particle Industries, Inc
Address	325 9th St, San Francisco, CA 94103 USA, 415-319-1553

Manufacturer or Supplier	Particle Industries, Inc	
Address	325 9th St, San Francisco, CA 94103 USA, 415-319-1553	
Product	M SoM	
Brand Name	Particle	
Model	M524	
Additional Model & Model Difference	N/A	
Date of tests	Jan. 11, 2024 ~ Feb. 23, 2024	

The submitted sample of the above equipment has been tested according to the requirements of the following standards:

EN 300 328 V2.2.2 (2019-07)

CONCLUSION: The submitted sample was found to COMPLY with the test requirement

Tested by Lucas Chen Project Engineer / EMC Department	Approved by Glyn He Assistant Manager / EMC Department
	Date: Mar. 05, 2024

This report is governed by, and incorporates by reference, the Conditions of Testing as posted at the date of issuance of this report at <http://www.bureauveritas.com/home/about-us/our-business/cps/about-us/terms-conditions/> and is intended for your exclusive use. Any copying or replication of this report to or for any other person or entity, or use of our name or trademark, is permitted only with our prior written permission. This report sets forth our findings solely with respect to the test samples identified herein. The results set forth in this report are not indicative or representative of the quality or characteristics of the lot from which a test sample was taken or any similar or identical product unless specifically and expressly noted. Our report includes all of the tests requested by you and the results thereof based upon the information that you provided to us. Measurement uncertainty is only provided upon request for accredited tests. Statements of conformity are based on simple acceptance criteria without taking measurement uncertainty into account, unless otherwise requested in writing. You have 60 days from date of issuance of this report to notify us of any material error or omission caused by our negligence or if you require measurement uncertainty; provided, however, that such notice shall be in writing and shall specifically address the issue you wish to raise. A failure to raise such issue within the prescribed time shall constitute your unqualified acceptance of the completeness of this report, the tests conducted and the correctness of the report contents.



TABLE OF CONTENTS

RELEASE CONTROL RECORD 4

1. SUMMARY OF TEST RESULTS 5

1.1. TEST INSTRUMENTS 6

1.2. MEASUREMENT UNCERTAINTY 8

1.3. MAXIMUM MEASUREMENT UNCERTAINTY 8

2. GENERAL INFORMATION..... 9

2.1. GENERAL DESCRIPTION OF EUT 9

2.2. DESCRIPTION OF TEST MODES..... 10

2.2.1. TEST MODE APPLICABILITY AND TESTED CHANNEL DETAIL.....11

2.3. GENERAL DESCRIPTION OF APPLIED STANDARDS 15

2.4. DESCRIPTION OF SUPPORT UNITS 15

3 TEST PROCEDURES AND RESULTS 16

TRANSMITTER PARAMETERS 16

3.1. RF OUTPUT POWER 16

3.1.1. LIMITS OF RF OUTPUT POWER 16

3.1.2. TEST PROCEDURE..... 16

3.1.3. DEVIATION FROM TEST STANDARD 16

3.1.4. TEST SETUP 16

3.1.5. TEST RESULTS 17

3.2. POWER SPECTRAL DENSITY 18

3.2.1. LIMIT OF POWER SPECTRAL DENSITY 18

3.2.2. TEST PROCEDURE..... 18

3.2.3. DEVIATION FROM TEST STANDARD 18

3.2.4. TEST SETUP 18

3.2.5. TEST RESULTS 19

3.3. OCCUPIED CHANNEL BANDWIDTH 20

3.3.1. LIMIT OF OCCUPIED CHANNEL BANDWIDTH..... 20

3.3.2. TEST PROCEDURE..... 20

3.3.3. DEVIATION FROM TEST STANDARD 20

3.3.4. TEST SETUP 20

3.3.5. TEST RESULTS 21

3.4. TRANSMITTER UNWANTED EMISSIONS IN THE OUT-OF-BAND DOMAIN 22

3.4.1. LIMITS OF TRANSMITTER UNWANTED EMISSIONS IN THE OUT-OF-BAND DOMAIN..... 22

3.4.2. TEST PROCEDURE..... 22

3.4.3. DEVIATION FROM TEST STANDARD 22

3.4.4. TEST SETUP 23

3.4.5. TEST RESULTS 23

3.5. ADAPTIVE (CHANNEL ACCESS MECHANISM)..... 25

3.5.1. APPLICABILITY OF ADAPTIVE REQUIREMENTS AND LIMIT FOR WIDE BAND MODULATION TECHNIQUES..... 25

3.5.2. TEST PROCEDURES 26

3.5.3. TEST SETUP CONFIGURATION..... 26

3.5.4. INTERFERENCE THRESHOLD LEVEL 27

3.5.5. LIST OF MEASUREMENTS..... 28

3.5.6. TEST RESULT 29

3.5.6.1. ADAPTIVE RESULT 29

3.5.6.2. THE CHANNEL OCCUPANCY TIME RESULT 36



3.6.	TRANSMITTER SPURIOUS EMISSIONS	39
3.6.1.	LIMITS OF TRANSMITTER SPURIOUS EMISSIONS.....	39
3.6.2.	TEST PROCEDURE.....	39
3.6.3.	DEVIATION FROM TEST STANDARD	40
3.6.4.	TEST SETUP.....	40
3.6.5.	TEST RESULTS	41
	RECEIVER PARAMETERS	45
3.7.	RECEIVER SPURIOUS RADIATION.....	45
3.7.1.	LIMITS OF RECEIVER SPURIOUS RADIATION	45
3.7.2.	TEST PROCEDURE.....	45
3.7.3.	DEVIATION FROM TEST STANDARD	45
3.7.4.	TEST SETUP.....	45
3.7.5.	TEST RESULTS	46
3.8.	RECEIVER BLOCKING	49
3.8.1.	LIMITS OF RECEIVER BLOCKING	49
3.8.2.	TEST PROCEDURE.....	50
3.8.3.	DEVIATION FROM TEST STANDARD	50
3.8.4.	TEST SETUP CONFIGURATION.....	51
3.8.5.	TEST RESULT	52
4	PHOTOGRAPHS OF THE TEST CONFIGURATION	53
5	APPENDIX A – MODIFICATIONS RECORDERS FOR ENGINEERING CHANGES TO THE EUT BY THE LAB.....	55



BUREAU
VERITAS

Test Report No.: RE2312WDG0148-2

RELEASE CONTROL RECORD

ISSUE NO.	REASON FOR CHANGE	DATE ISSUED
RE2312WDG0148-2	Original release	Mar. 05, 2024



1. SUMMARY OF TEST RESULTS

The EUT has been tested according to the following specifications:

EN 300 328 V2.2.2		
Clause	Test Parameter	Results
	TRANSMITTER PARAMETERS	
4.3.2.2	RF Output Power	Pass
4.3.2.3	Power Spectral Density	Pass
4.3.2.6	Adaptivity	Pass
4.3.2.7	Occupied Channel Bandwidth	Pass
4.3.2.8	Transmitter unwanted emission in the OOB domain	Pass
4.3.2.9	Transmitter unwanted emissions in the spurious domain	Pass
4.3.2.12	Geo-location capability	Not Applicable
	RECEIVER PARAMETERS	
4.3.2.10	Receiver Spurious Emissions	Pass
4.3.2.11	Receiver Blocking	Pass



1.1. TEST INSTRUMENTS

Equipment	Manufacturer	Model No.	Serial No.	Next Cal.
EMI Test Receiver	Rohde&Schwarz	ESU40	100449	Jan. 02, 25
Signal and Spectrum Analyzer	Rohde&Schwarz	FSV40	101094	Jan. 01, 25
Trilog-Broadband Antenna	SCHWARZBECK	VULB 9168	9168-554	Jan. 08, 25
Horn Antenna	ETS-Lindgren	3117	00062558	Apr.01, 24
GPS Generator+ Antenna	TOJOIN	GNSS-5000A	E1-010119	N/A
3m Semi-anechoic Chamber	ETS-LINDGREN	9m*6m*6m	NSEMC003	May. 20, 24
Test Software	ADT	ADT_Radiated_V7.6.15.9.2	N/A	N/A
Test software	ADT	ADT_RF Test Software V6.6.5.3	N/A	N/A
Horn Antenna (15GHz-40GHz)	SCHWARZBECK	BBHA 9170	BBHA9170147	Apr. 01, 24
Amplifier	Burgeon	BPA-530	100220	Mar. 06, 24
Broadband Preamplifier (1GHz~18GHz)	SCHWARZBECK	BBV9718	305	Apr. 24, 24
Pre-Amplifier (18GHz-40GHz)	EMCI	EMC 184045	980102	Jan. 02 25
Power Sensor	Keysight	U2021XA	MY57320002	May. 11, 24
Humid & Temp Programmable Tester	Haida	HD-225T	1108072001	Oct. 15, 24
Oscilloscope	Agilent	DSO9254A	MY51260160	Jul. 11, 24
Signal and Spectrum Analyzer	Rohde&Schwarz	FSV7	102331	Apr 05, 24
Spectrum Analyzer	Keysight	N9020A	MY55400499	Jan. 01, 25
MXG-B RF Vector Signal Generator	Keysight	N5182B	MY56200288	Jul. 11, 24
Wireless Connectivity Tester	Rohde&Schwarz	CMW270	102426	Apr. 05, 24
Vector Signal Generator	Rohde&Schwarz	SMBV100A	257579	Oct. 15, 24
Attenuator	MINI	BW-S10W2+	S130129FGE2	N/A

NOTES:

1. The test was performed in 966 Chamber and RF Oven room.
2. The calibration interval of the above test instruments is 12 months, and the calibrations are traceable to CEPREI/CHINA, GRGT/CHINA and NIM/CHINA.
3. The horn antenna is used only for the measurement of emission frequency above 1GHz if tested.

**For Receiver Blocking test and Adaptivity test:**

Equipment	Manufacturer	Model No.	Serial No.	Next Cal.
Wireless Connectivity Tester	Rohde&Schwarz	CMW270	102426	Apr. 05, 24
Signal Analyzer	Rohde&Schwarz	FSV7	102331	Apr. 05, 24
Spectrum Analyzer	Keysight	N9020A	MY55400499	Jan. 01, 25
Signal Generator	Agilent	N5183A	MY50140980	Jul. 23, 24
MXG-B RF Vector Signal Generator	Keysight	N5182B	MY56200288	Jul. 11, 24
Power Sensor	Keysight	U2021XA	MY57320002	May. 11, 24
Vector Signal Generator	Rohde&Schwarz	SMBV100A	257579	Oct. 15, 24
Agile Signal Generator	Agilent	8645A	Agilent	N/A
Shield Box	TOJOIN	MS4345-C	SZA18A 3038	N/A
Attenuator	TOJOIN	CHB-8-90-1-B 50SMA	0803002	N/A
COM Power Splitter	TOJOIN	PS-TX-2B	020801	N/A
COM Power Splitter	TOJOIN	PS-TX-2B	020802	N/A
Test software	TonScend	JS1120-3-1	V2.6.88.0330	N/A

NOTES:

1. The test was performed in RF Oven room.
2. The calibration interval of the above test instruments is 12 months, and the calibrations are traceable to CEPREI/CHINA, GRGT/CHINA and NIM/CHINA.



1.2. MEASUREMENT UNCERTAINTY

Where relevant, the following measurement uncertainty levels have been estimated for tests performed on the EUT:

This uncertainty represents an expanded uncertainty expressed at approximately the 95% confidence level using a coverage factor of k=2.

Parameter	Uncertainty
Occupied Channel Bandwidth	±1.132 %
RF output power, conducted	±0.56dB
Power Spectral Density, conducted	±1.017dB
Unwanted Emissions, conducted	±1.017dB
All emissions, radiated	±4.84dB
Temperature	±0.23°C
Supply voltages	±0.1 %
Time	±4 %

1.3. MAXIMUM MEASUREMENT UNCERTAINTY

For the test methods, according to ETSI EN 300 328 standard, the measurement uncertainty figures shall be calculated in accordance with ETR 100 028-1 [4] and shall correspond to an expansion factor (coverage factor) k = 1,96 or k = 2 (which provide confidence levels of respectively 95 % and 95,45 % in the case where the distributions characterizing the actual measurement uncertainties are normal (Gaussian)).

Maximum measurement uncertainty

Parameter	Uncertainty
Occupied Channel Bandwidth	±5 %
RF output power, conducted	±1,5 dB
Power Spectral Density, conducted	±3 dB
Unwanted Emissions, conducted	±3 dB
All emissions, radiated	±6 dB
Temperature	±3 °C
Supply voltages	±3 %
Time	±5 %



2. GENERAL INFORMATION

2.1. GENERAL DESCRIPTION OF EUT

PRODUCT	M SoM
TEST MODEL	M524
ADDITIONAL MODEL	N/A
NOMINAL VOLTAGE	VCC: 3.8V. 3V3:3.3V
OPERATING TEMPERATURE RANGE	-35 ~ +75°C
MODULATION TECHNOLOGY	DSSS, OFDM
MODULATION TYPE	CCK, DQPSK, DBPSK for DSSS 64QAM, 16QAM, QPSK, BPSK for OFDM
OPERATING FREQUENCY	2412-2472MHz for 11b/g/n(HT20)
ADPTIVE/NON-ADPTIVE	<input type="checkbox"/> non-adaptive Equipment <input checked="" type="checkbox"/> adaptive Equipment without the possibility to switch to a non-adaptive mode <input type="checkbox"/> adaptive Equipment which can also operate in a non-adaptive mode
EIRP (MAX.)	19.89dBm
ANTENNA TYPE	PCB Antenna, 3dBi Gain
CABLE SUPPLIED	N/A

Notes:

1. The above EUT information is declared by manufacturer and for more detailed features description, please refer to the manufacturer's specifications or user's manual.
2. For the test results, the EUT had been tested with all conditions, but only the worst case was shown in test report.
3. Please refer to the EUT photo document (Reference No.: W7L-P23120016) for detailed product photo.
4. The EUT provides completed transmitters and receivers, the EUT uses only one antenna at any time.

MODULATION MODE	TX FUNCTION
802.11b	1TX/1RX
802.11g	1TX/1RX
802.11n (HT20)	1TX/1RX



2.2. DESCRIPTION OF TEST MODES

13 channels are provided for 802.11b, 802.11g and 802.11n (HT20):

CHANNEL	FREQUENCY	CHANNEL	FREQUENCY
1	2412 MHz	8	2447 MHz
2	2417 MHz	9	2452 MHz
3	2422 MHz	10	2457 MHz
4	2427 MHz	11	2462 MHz
5	2432 MHz	12	2467 MHz
6	2437 MHz	13	2472 MHz
7	2442 MHz		



ADAPTIVITY TEST:

Following channel(s) was (were) selected for the final test as listed below.

MODE	AVAILABLE CHANNEL	TESTED CHANNEL	MODULATION TECHNOLOGY
802.11b	1 to 13	1, 13	DSSS
802.11g	1 to 13	1, 13	OFDM
802.11n (HT20)	1 to 13	1, 13	OFDM

OCCUPIED CHANNEL BANDWIDTH TEST:

Pre-Scan has been conducted to determine the worst-case mode from all possible combinations between available modulations, data rates and antenna ports (if EUT with antenna diversity architecture).

Following channel(s) was (were) selected for the final test as listed below.

MODE	AVAILABLE CHANNEL	TESTED CHANNEL	MODULATION TECHNOLOGY	MODULATION TYPE	DATA RATE (Mbps)
802.11b	1 to 13	1, 13	DSSS	DBPSK	1.0
802.11g	1 to 13	1, 13	OFDM	BPSK	6.0
802.11n (HT20)	1 to 13	1, 13	OFDM	BPSK	6.5

TRANSMITTER UNWANTED EMISSION IN THE OUT-OF-BAND DOMAIN TEST:

Pre-Scan has been conducted to determine the worst-case mode from all possible combinations between available modulations, data rates and antenna ports (if EUT with antenna diversity architecture).

Following channel(s) was (were) selected for the final test as listed below.

MODE	AVAILABLE CHANNEL	TESTED CHANNEL	MODULATION TECHNOLOGY	MODULATION TYPE	DATA RATE (Mbps)
802.11b	1 to 13	1, 13	DSSS	DBPSK	1.0
802.11g	1 to 13	1, 13	OFDM	BPSK	6.0
802.11n (HT20)	1 to 13	1, 13	OFDM	BPSK	6.5



SPURIOUS EMISSIONS TEST (BELOW 1 GHz):

- Pre-Scan has been conducted to determine the worst-case mode from all possible combinations between available modulations, data rates and antenna ports (if EUT with antenna diversity architecture).
- Following channel(s) was (were) selected for the final test as listed below.

MODE	AVAILABLE CHANNEL	TESTED CHANNEL	MODULATION TECHNOLOGY	MODULATION TYPE	DATA RATE (Mbps)
802.11b	1 to 13	1	DSSS	DBPSK	1
Receiver	1 to 13	1	-	-	-

SPURIOUS EMISSIONS TEST (ABOVE 1 GHz):

- Pre-Scan has been conducted to determine the worst-case mode from all possible combinations between available modulations, data rates and antenna ports (if EUT with antenna diversity architecture).
- Following channel(s) was (were) selected for the final test as listed below.

MODE	AVAILABLE CHANNEL	TESTED CHANNEL	MODULATION TECHNOLOGY	MODULATION TYPE	DATA RATE (Mbps)
802.11b	1 to 13	1, 13	DSSS	DBPSK	1.0
802.11g	1 to 13	1, 13	OFDM	BPSK	6.0
802.11n (HT20)	1 to 13	1, 13	OFDM	BPSK	6.5
Receiver	1 to 13	1, 13	-	-	-

RECEIVER BLOCKING TEST:

- Following channel(s) was (were) selected for the final test as listed below.

MODE	AVAILABLE CHANNEL	TESTED CHANNEL	MODULATION TECHNOLOGY	MODULATION TYPE	DATA RATE (Mbps)
802.11b	1 to 13	1, 13	DSSS	DBPSK	1.0



TEST CONDITION:

APPLICABLE TO	ENVIRONMENTAL CONDITIONS	INPUT POWER	TESTED BY
ROP	25deg. C, 60%RH	DC 3.8V from SOM Mini SYS test board	Vincent
PSD	25deg. C, 60%RH	DC 3.8V from SOM Mini SYS test board	Vincent
AD	25deg. C, 60%RH	DC 3.8V from SOM Mini SYS test board	Vincent
OCB	25deg. C, 60%RH	DC 3.8V from SOM Mini SYS test board	Vincent
OOB	25deg. C, 60%RH	DC 3.8V from SOM Mini SYS test board	Vincent
RSE<1G	27deg. C, 56%RH	DC 3.8V from SOM Mini SYS test board	Stalker
RSE≥1G	27deg. C, 56%RH	DC 3.8V from SOM Mini SYS test board	Stalker
RB	25deg. C, 60%RH	DC 3.8V from SOM Mini SYS test board	Yoyo



2.3. GENERAL DESCRIPTION OF APPLIED STANDARDS

The EUT is a RF product, according to the specifications of the manufacturers. It must comply with the requirements of the following standards:

EN 300 328 V2.2.2 (2019-07)

All test items have been performed and recorded as per the above standards.

2.4. DESCRIPTION OF SUPPORT UNITS

The EUT has been tested as an independent unit together with other necessary accessories or support units. The following support units or accessories were used to form a representative test configuration during the tests.

NO.	PRODUCT	BRAND	MODEL NO.	SERIAL NO.	FCC ID
1	Notebook	DELL	Inspiron 13-7378	GMSJZD2	N/A
2	SOM Mini SYS test board	N/A	V0.8	N/A	N/A
3	Adaptor	SONY	AC-UUD12	190112010051	N/A

NO.	SIGNAL CABLE DESCRIPTION OF THE ABOVE SUPPORT UNITS
1	AC Line: Unshielded, Detachable 0.8m; DC Line: Unshielded, Non-detachable 1.8m USB Cable: Shielded, Detachable, 0.5m
2	N/A
3	USB Cable: Shielded, Detachable, 0.5m



3 TEST PROCEDURES AND RESULTS

TRANSMITTER PARAMETERS

3.1. RF OUTPUT POWER

3.1.1. LIMITS OF RF OUTPUT POWER

CONDITION	FREQUENCY BAND	LIMIT (e.i.r.p.)
Under all test conditions	2400 ~ 2483.5 MHz	AV: 20dBm

3.1.2. TEST PROCEDURE

Refer to chapter 5.4.2.2 of ETSI EN 300 328 V2.2.2.

Measurement	
<input checked="" type="checkbox"/> Conducted measurement	<input type="checkbox"/> Radiated measurement

3.1.3. DEVIATION FROM TEST STANDARD

No deviation.

3.1.4. TEST SETUP

The measurement was performed at both normal environmental conditions and at the extremes of the operating temperature. The measurement was performed at the lowest, the middle, and the highest channel. The equipment was configured to operate under its worst-case situation with respect to output power. (In case of conducted measurements the transmitter shall be connected to the measuring equipment via a suitable attenuator.) Controlling software has been activated to set the EUT on specific channel and power level.



3.1.5. TEST RESULTS

TEST CONDITION			EIRP POWER (dBm)		
			(CH1) 2412 MHz	(CH7) 2442 MHz	(CH13) 2472 MHz
802.11b					
T _{nom} (°C)	+25	V _{nom} (V)	18.46	17.59	17.87
T _{min} (°C)	-35		18.75	17.69	18.14
T _{max} (°C)	+75		18.26	17.32	17.48
802.11g					
T _{nom} (°C)	+25	V _{nom} (V)	19.45	18.01	18.66
T _{min} (°C)	-35		19.89	18.13	18.95
T _{max} (°C)	+75		18.96	17.66	18.34
802.11n (HT20)					
T _{nom} (°C)	+25	V _{nom} (V)	19.58	18.13	18.88
T _{min} (°C)	-35		19.82	18.36	19.12
T _{max} (°C)	+75		19.08	18.00	18.47

NOTE: EIRP = Conducted output power + ANT Gain.



3.2. POWER SPECTRAL DENSITY

3.2.1. LIMIT OF POWER SPECTRAL DENSITY

CONDITION	FREQUENCY BAND	LIMIT (e.i.r.p.)
Under normal conditions	2400 ~ 2483.5 MHz	10dBm / 1MHz

3.2.2. TEST PROCEDURE

Refer to chapter 5.4.3.2 of ETSI EN 300 328 V2.2.2.

Measurement Method	
<input checked="" type="checkbox"/> Conducted measurement	<input type="checkbox"/> Radiated measurement
<input checked="" type="checkbox"/> Option 1: For equipment with continuous and non-continuous transmissions	
<input type="checkbox"/> Option 2: For equipment with continuous transmission capability or for equipment operating (or with the capability to operate) with a constant duty cycle (e.g. Frame Based equipment)	

3.2.3. DEVIATION FROM TEST STANDARD

No deviation.

3.2.4. TEST SETUP

The measurement was performed at normal environmental conditions only. The measurement was performed at the lowest, the middle, and the highest channel. The equipment was configured to operate under its worst-case situation with respect to output power. (In case of conducted measurements the transmitter shall be connected to the measuring equipment via a suitable attenuator.) Controlling software has been activated to set the EUT on specific status.



3.2.5. TEST RESULTS

802.11b

CHANNEL	CHANNEL FREQUENCY (MHz)	POWER DENSITY (dBm/1MHz) (E.I.R.P)	LIMIT (dBm/1MHz) (E.I.R.P)	PASS/FAIL
1	2412.00	9.95	10	PASS
7	2442.00	8.94	10	PASS
13	2472.00	9.37	10	PASS

802.11g

CHANNEL	CHANNEL FREQUENCY (MHz)	POWER DENSITY (dBm/1MHz) (E.I.R.P)	LIMIT (dBm/1MHz) (E.I.R.P)	PASS/FAIL
1	2412.00	8.16	10	PASS
7	2442.00	6.28	10	PASS
13	2472.00	7.29	10	PASS

802.11n (HT20)

CHANNEL	CHANNEL FREQUENCY (MHz)	POWER DENSITY (dBm/1MHz) (E.I.R.P)	LIMIT (dBm/1MHz) (E.I.R.P)	PASS/FAIL
1	2412.00	8.05	10	PASS
7	2442.00	6.19	10	PASS
13	2472.00	7.23	10	PASS



3.3. OCCUPIED CHANNEL BANDWIDTH

3.3.1. LIMIT OF OCCUPIED CHANNEL BANDWIDTH

CONDITION		LIMIT
All types of equipment		Shall fall completely within the band 2400 to 2483.5 MHz.
Additional requirement	For non-adaptive using wide band modulations other than FHSS system and e.i.r.p >10dBm.	Less than 20MHz
	For non-adaptive Frequency Hopping system and e.i.r.p >10dBm.	Less than 5MHz

3.3.2. TEST PROCEDURE

Refer to chapter 5.4.7.2 of ETSI EN 300 328 V2.2.2.

Measurement	
<input checked="" type="checkbox"/> Conducted measurement	<input type="checkbox"/> Radiated measurement

3.3.3. DEVIATION FROM TEST STANDARD

No deviation.

3.3.4. TEST SETUP

The measurement was performed at normal environmental conditions only. This measurement was performed at the lowest and the highest channel. The equipment was configured to operate under its worst-case situation with respect to output power. (In case of conducted measurements the transmitter shall be connected to the measuring equipment via a suitable attenuator.) Controlling software has been activated to set the EUT on specific status.



3.3.5. TEST RESULTS

802.11b

CHANNEL	CHANNEL FREQUENCY (MHz)	OCCUPIED BANDWIDTH (MHz)	Measured frequencies		LIMIT	PASS/FAIL
			FL (MHz)	FH (MHz)		
1	2412	14.88	2404.72	2419.60	FL > 2400 MHz and FH < 2483.5 MHz	PASS
13	2472	15.04	2464.40	2479.44		PASS

802.11g

CHANNEL	CHANNEL FREQUENCY (MHz)	OCCUPIED BANDWIDTH (MHz)	Measured frequencies		LIMIT	PASS/FAIL
			FL (MHz)	FH (MHz)		
1	2412	17.04	2403.60	2420.64	FL > 2400 MHz and FH < 2483.5 MHz	PASS
13	2472	17.12	2463.44	2480.56		PASS

802.11n (HT20)

CHANNEL	CHANNEL FREQUENCY (MHz)	OCCUPIED BANDWIDTH (MHz)	Measured frequencies		LIMIT	PASS/FAIL
			FL (MHz)	FH (MHz)		
1	2412	18.16	2403.04	2421.20	FL > 2400 MHz and FH < 2483.5 MHz	PASS
13	2472	18.24	2462.88	2481.12		PASS

Note: FL is the lowest frequency of the 99% occupied bandwidth of power envelope.
FH is the highest frequency of the 99% occupied bandwidth of power envelope.



3.4. TRANSMITTER UNWANTED EMISSIONS IN THE OUT-OF-BAND DOMAIN

3.4.1. LIMITS OF TRANSMITTER UNWANTED EMISSIONS IN THE OUT-OF-BAND DOMAIN

CONDITION	LIMIT
Under all test conditions	The transmitter unwanted emissions in the out-of-band domain but outside the allocated band, shall not exceed the values provided by the mask in below figure.

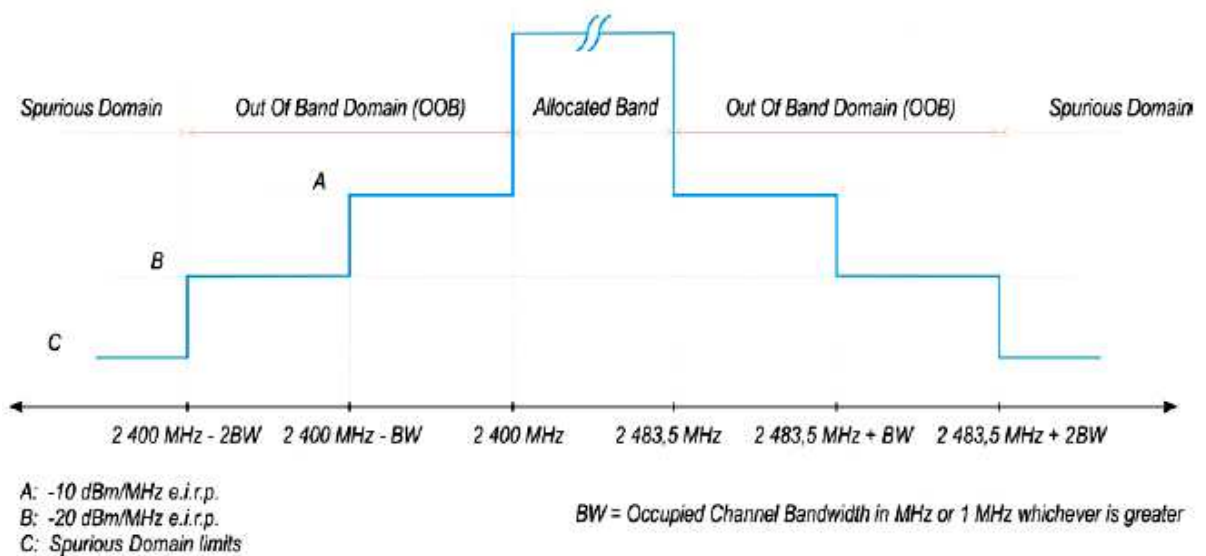

3.4.2. TEST PROCEDURE

Refer to chapter 5.4.8.2 of ETSI EN 300 328 V2.2.2.

Measurement	
<input checked="" type="checkbox"/> Conducted measurement	<input type="checkbox"/> Radiated measurement

3.4.3. DEVIATION FROM TEST STANDARD

No deviation.



3.4.4. TEST SETUP

The measurement was performed at normal environmental conditions only. This measurement was performed at the lowest and the highest channel. The equipment was configured to operate under its worst-case situation with respect to output power. (In case of conducted measurements the transmitter shall be connected to the measuring equipment via a suitable attenuator.) The frequency has to be recorded for the right and left end above threshold of highest and lowest channel respectively.

3.4.5. TEST RESULTS

802.11b

CHANNEL FREQ.(MHz)			2412				2472			
TEST CONDITION			OOB Emission (MHz)				OOB Emission (MHz)			
			2385.12 ~ 2400		2370.24 ~ 2385.12		2483.5 ~ 2498.54		2498.54 ~ 2513.58	
Temperature	Voltage		Freq. (MHz)	Power (dBm)	Freq. (MHz)	Power (dBm)	Freq. (MHz)	Power (dBm)	Freq. (MHz)	Power (dBm)
Tnorm(°C)	25	Normal	2399.50	-36.90	2384.62	-57.13	2487.00	-42.65	2498.88	-57.87
Limit (dBm/MHz)			-10.00		-20.00		-10.00		-20.00	
PASS/FAIL			PASS		PASS		PASS		PASS	

802.11g

CHANNEL FREQ.(MHz)			2412				2472			
TEST CONDITION			OOB Emission (MHz)				OOB Emission (MHz)			
			2382.96 ~ 2400		2365.92 ~ 2382.96		2483.5 ~ 2500.62		2500.62 ~ 2517.74	
Temperature	Voltage		Freq. (MHz)	Power (dBm)	Freq. (MHz)	Power (dBm)	Freq. (MHz)	Power (dBm)	Freq. (MHz)	Power (dBm)
Tnorm(°C)	25	Normal	2399.50	-26.04	2382.46	-54.43	2484.00	-28.65	2505.04	-58.04
Limit (dBm/MHz)			-10.00		-20.00		-10.00		-20.00	
PASS/FAIL			PASS		PASS		PASS		PASS	



802.11n (HT20)

CHANNEL FREQ.(MHz)			2412				2472			
TEST CONDITION			OOB Emission (MHz)				OOB Emission (MHz)			
			2381.84 ~ 2400		2363.68 ~ 2381.84		2483.5 ~ 2501.74		2501.74 ~ 2519.98	
Temperature		Voltage	Freq. (MHz)	Power (dBm)	Freq. (MHz)	Power (dBm)	Freq. (MHz)	Power (dBm)	Freq. (MHz)	Power (dBm)
Tnorm(°C)	25	Normal	2399.50	-26.58	2381.34	-55.95	2484.00	-29.54	2505.16	-57.95
Limit (dBm/MHz)			-10.00		-20.00		-10.00		-20.00	
PASS/FAIL			PASS		PASS		PASS		PASS	



3.5. ADAPTIVE (CHANNEL ACCESS MECHANISM)

3.5.1. APPLICABILITY OF ADAPTIVE REQUIREMENTS AND LIMIT FOR WIDE BAND MODULATION TECHNIQUES

Requirement	Operational Mode			
	Non-LBT based Detect and Avoid	LBT based Detect and Avoid		
		Frame Based Equipment	Load Based Equipment (CCA using 'energy detect')	Load Based Equipment (CCA not using any of the mechanisms referenced as note 2)
Minimum Clear Channel Assessment (CCA) Time	NA	18 us (see note 1)	(see note 2)	18 us (see note 1)
Maximum Channel Occupancy (COT) Time	40 ms	1 ms to 10 ms	(see note 2)	13 ms
Minimum Idle Period	5us	5% of COT	(see note 2)	18us (see note 3)
Extended CCA check	NA	NA	(see note 2)	18us~160us
Short Control Signalling Transmissions	Maximum duty cycle of 10 % within an observation period of 50 ms (see note 4)			

NOTE 1: The CCA time used by the equipment shall be declared by the supplier.
 NOTE 2: Load Based Equipment may implement an LBT based spectrum sharing mechanism based on the Clear Channel Assessment (CCA) mode using energy detect, as described in IEEE 802.11™-2012 clause 9, clause 10, clause 16, clause 17, clause 19 and clause 20, or in IEEE 802.15.4™-2011 [i.4], clause 4, clause 5 and clause 8
 NOTE 3: The Idle Period in between transmissions is considered to be the CCA or the Extended CCA check as there are no transmissions during this period.
 NOTE 4: Adaptive equipment may or may not have Short Control Signalling Transmissions

Interference threshold level

Maximum transmit power (P _H) EIRP dBm	Threshold level (TL) (see notes 1 and 2)
20	-70 dBm / MHz

NOTE 1: For a 20 dBm e.i.r.p. transmitter the CCA threshold level (TL) shall be equal to or less than -70 dBm/MHz at the input to the receiver assuming a 0 dBi (receive) antenna assembly. This threshold level (TL) may be corrected for the (receive) antenna assembly gain (G)
 NOTE 2: For power levels less than 20 dBm e.i.r.p. the CCA threshold level may be relaxed to:
 $TL = -70 \text{ dBm/MHz} + 10 \times \log_{10} (100 \text{ mW} / P_{out})$; (P_{out} in mW e.i.r.p.)

Wanted signal mean power from companion device	Unwanted signal frequency (MHz)	Unwanted signal power (dBm)
sufficient to maintain the link (see note 2)	2 395 or 2 488,5 (see note 1)	-35 (see note 3)

NOTE 1: The highest frequency shall be used for testing operating channels within the range 2 400 MHz to 2 442 MHz, while the lowest frequency shall be used for testing operating channels within the range 2 442 MHz to 2 483,5 MHz. See clause 5.4.6.1.
 NOTE 2: A typical value which can be used in most cases is -50 dBm/MHz.
 NOTE 3: The level specified is the level in front of the UUT antenna. In case of conducted measurements, this level has to be corrected by the actual antenna assembly gain.



3.5.2. TEST PROCEDURES

Refer to chapter 5.4.6.2 of ETSI EN 300 328 V2.2.2.

Measurement	
<input checked="" type="checkbox"/> Conducted measurement	<input type="checkbox"/> Radiated measurement

3.5.3. TEST SETUP CONFIGURATION

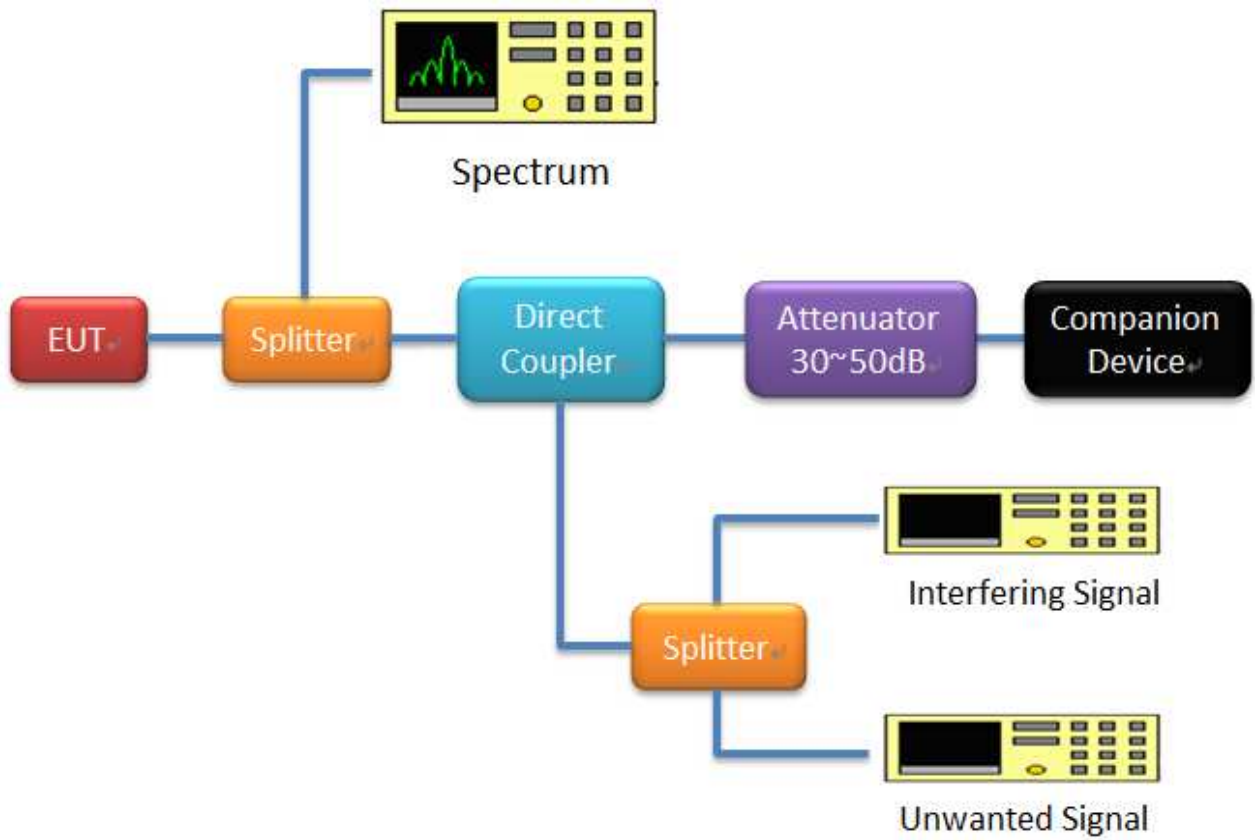



3.5.4. INTERFERENCE THRESHOLD LEVEL

Detection Threshold Level
The maximum EIRP power is 19.89dBm and antenna gain is 3dBi. Detection Threshold level= $-70 \text{ dBm/MHz} + 10 \times \log_{10} (100 \text{ mW} / (19.89\text{dBm})) + 3 = -66.89\text{dBm/MHz}$, the interference signal level to the UUT is -66.89dBm/MHz



3.5.5. LIST OF MEASUREMENTS

UUT Operational Mode	Applicable	Limit	
		The Maximum Channel Occupancy Time	The Minimum idle Period
Frame Based Equipment		meet in 1ms ~ 10ms	>5% x channel occupancy time
Load Based Equipment (Base on 'Spectrum Sharing' mechanisms)		Follow IEEE 802.11 Less than _____ms	Follow IEEE 802.11 More than _____ms
Load Based Equipment (Not using any of the mechanisms referenced)	v	13ms	18us

Clause	Test Parameter	Remarks	Pass/Fail
4.3.2.6.3.2.2	Adaptive (Frame Based Equipment)	Not Applicable	NA
4.3.2.6.3.2.3	Adaptive (Load Based Equipment)	Applicable	Pass
4.3.2.6.4	Short Control Signalling Transmissions	Applicable	Pass



3.5.6. TEST RESULT

3.5.6.1. ADAPTIVE RESULT

OPERATING FREQUENCY BANDS AND MODE OF EUT

Operational Mode	Operating Frequency - Low Channel (MHz)	Operating Frequency -High Channel (MHz)	Test Result
802.11b	2412	2472	PASS
802.11g	2412	2472	PASS
802.11n (HT20)	2412	2472	PASS



**BUREAU
VERITAS**

Test Report No.: RE2312WDG0148-2

802.11b

2412MHz

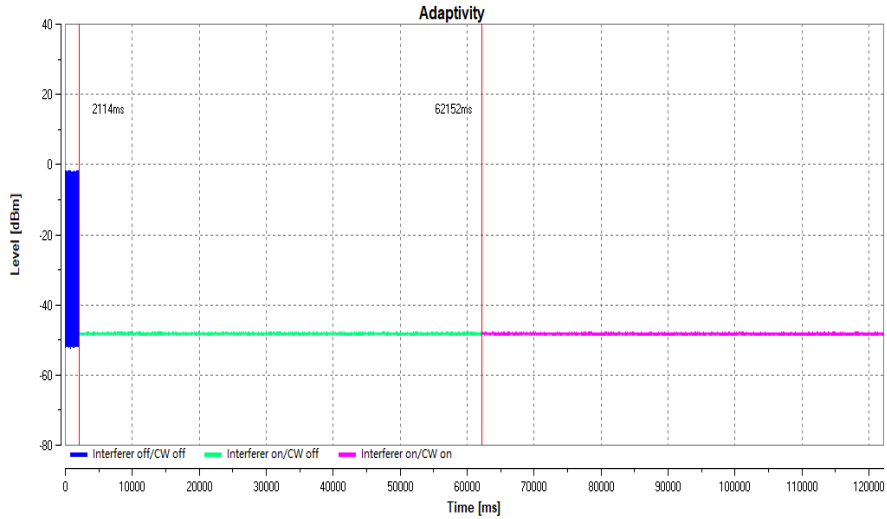

2472MHz

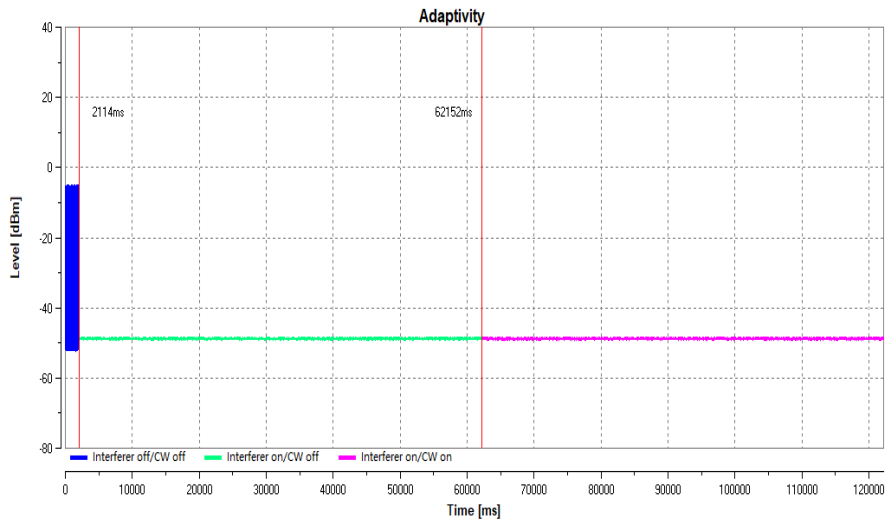



**BUREAU
VERITAS**

Test Report No.: RE2312WDG0148-2

Max. TxOn: 0.0 ms; Duty cycle: 0%

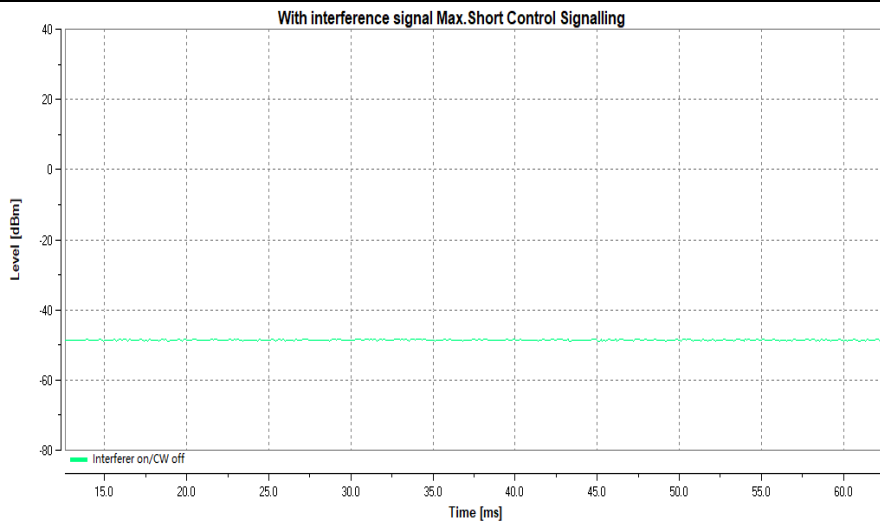



BUREAU
VERITAS

Test Report No.: RE2312WDG0148-2

802.11g

2412MHz

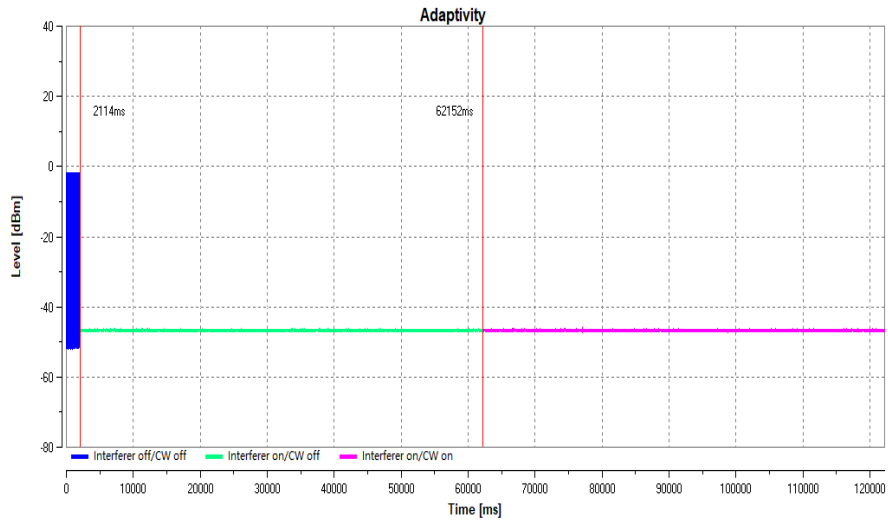

2472MHz

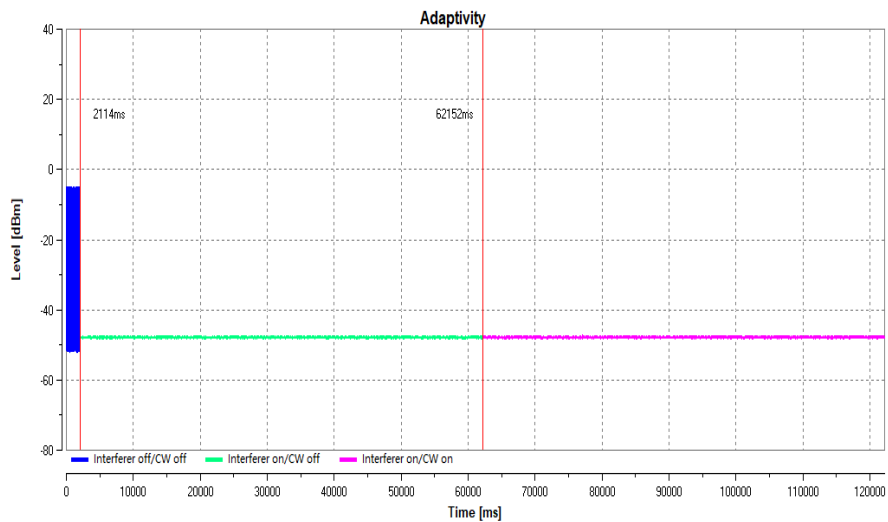



Max. TxOn: 0.0ms; Duty cycle: 0%

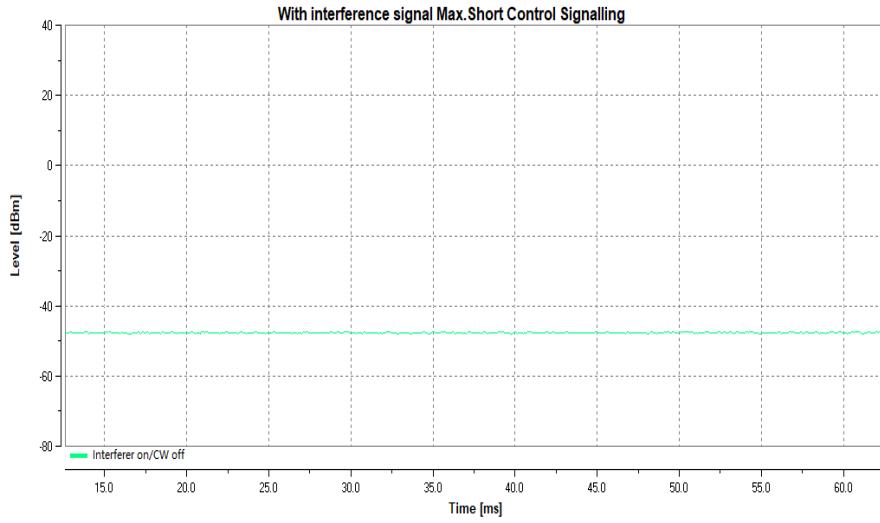



802.11n (HT20)

2412MHz

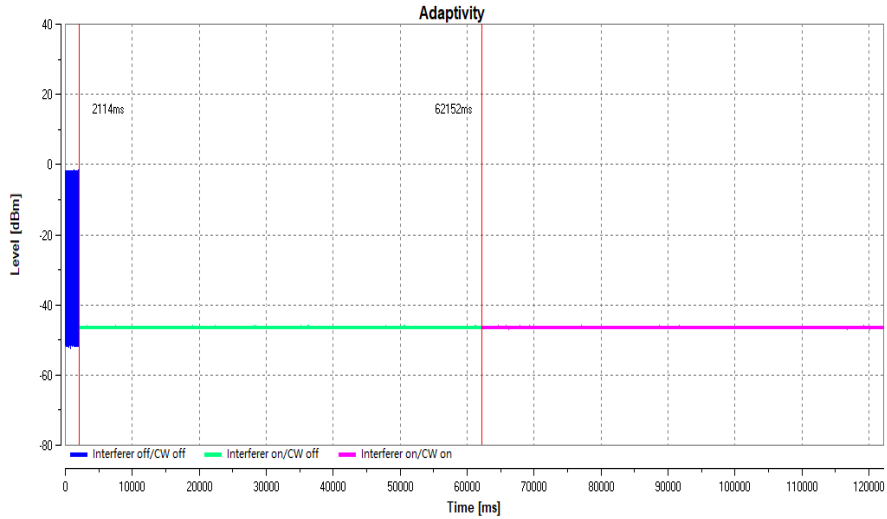

2472MHz

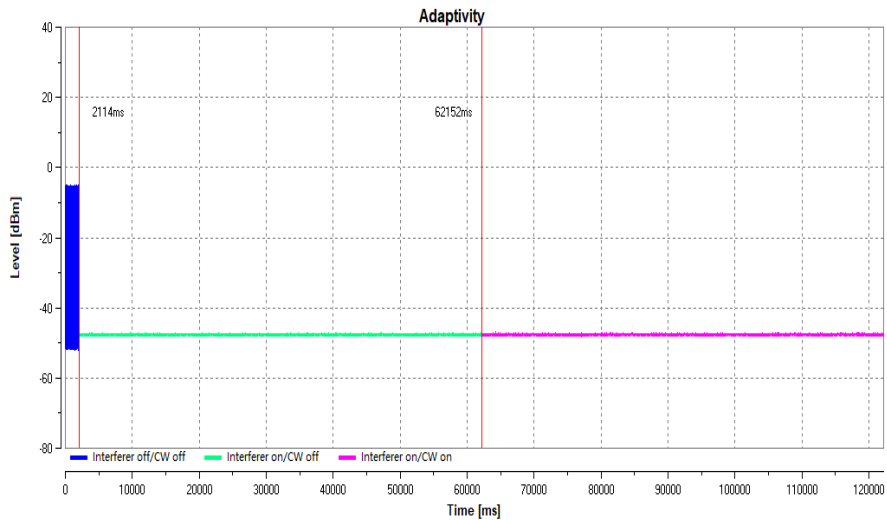



**BUREAU
VERITAS**

Test Report No.: RE2312WDG0148-2

Max. TxOn: 0.0ms; Duty cycle: 0%

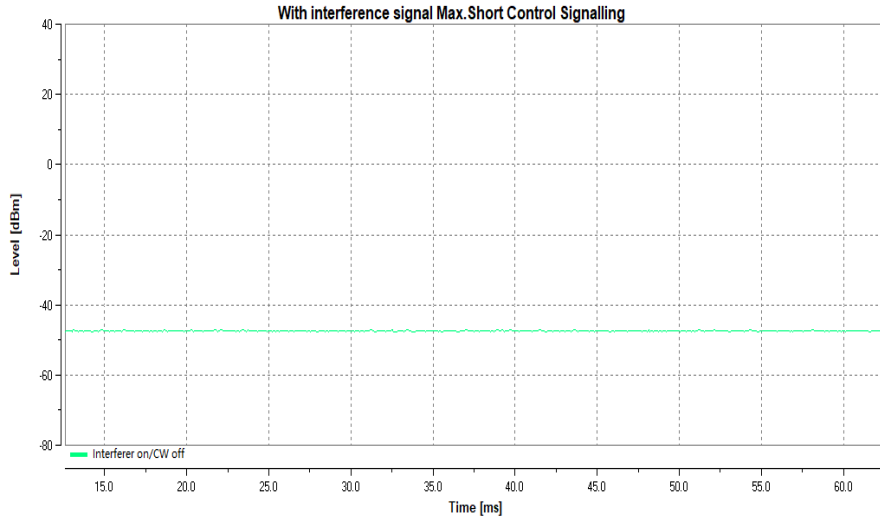



3.5.6.2. THE CHANNEL OCCUPANCY TIME RESULT

802.11b mode

The Channel occupancy Time: 12.628ms

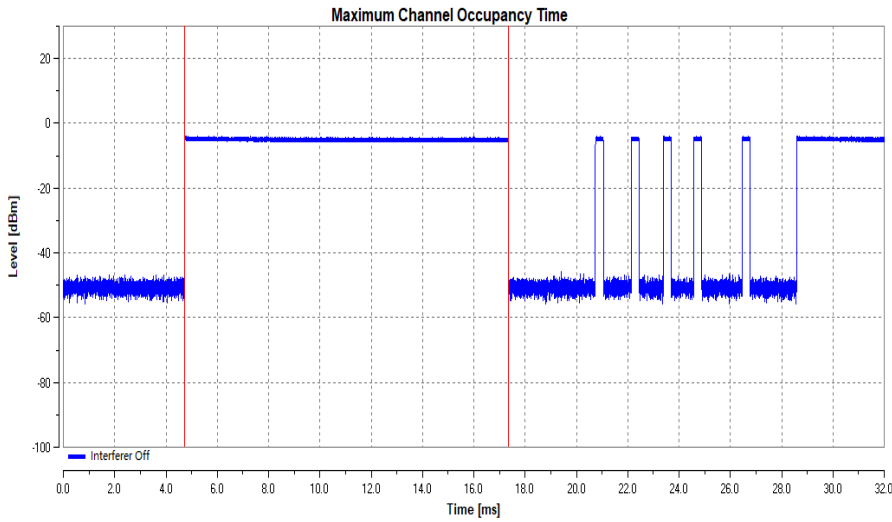

Minimum idle time: 0.15ms

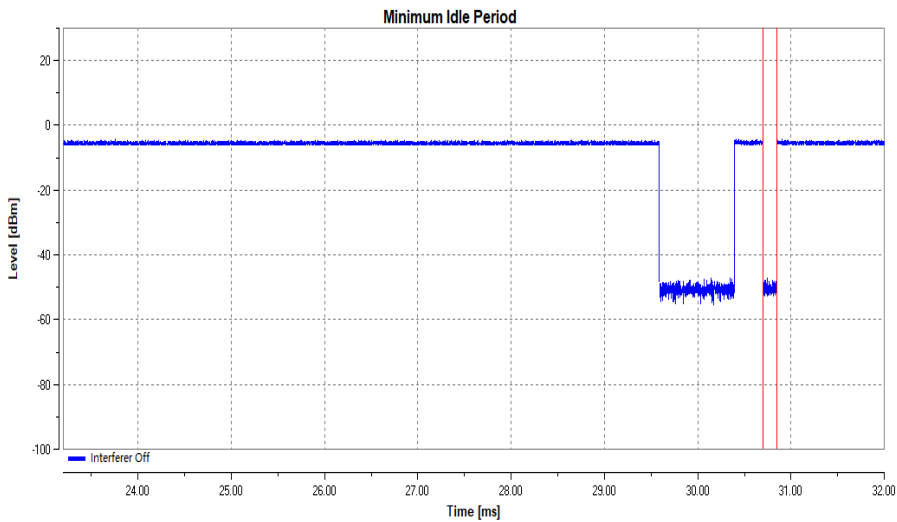



802.11g mode

The Channel occupancy Time: 12.628ms

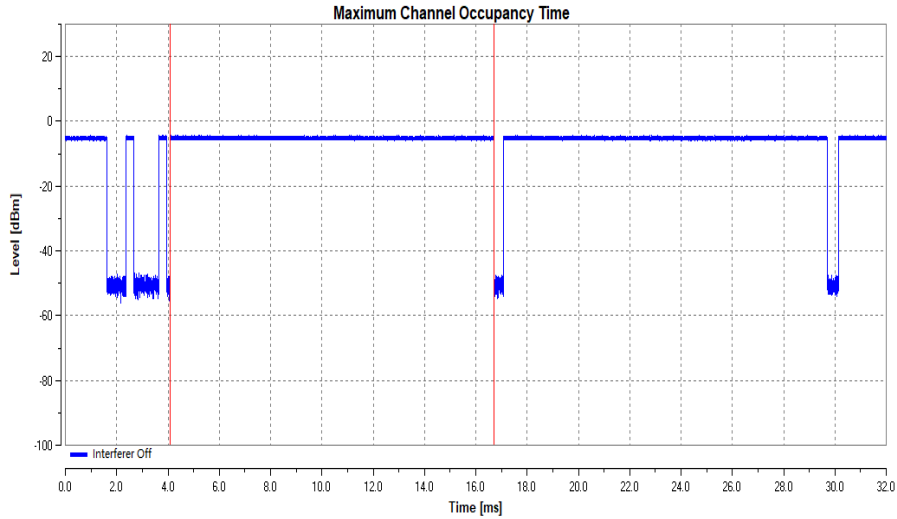

Minimum idle time: 0.045ms

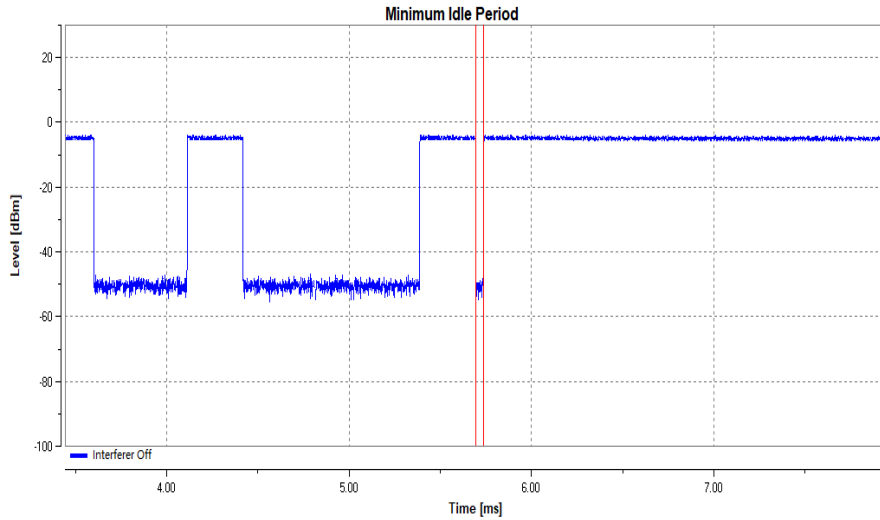



802.11nHT20 mode

The Channel occupancy Time: 12.628ms

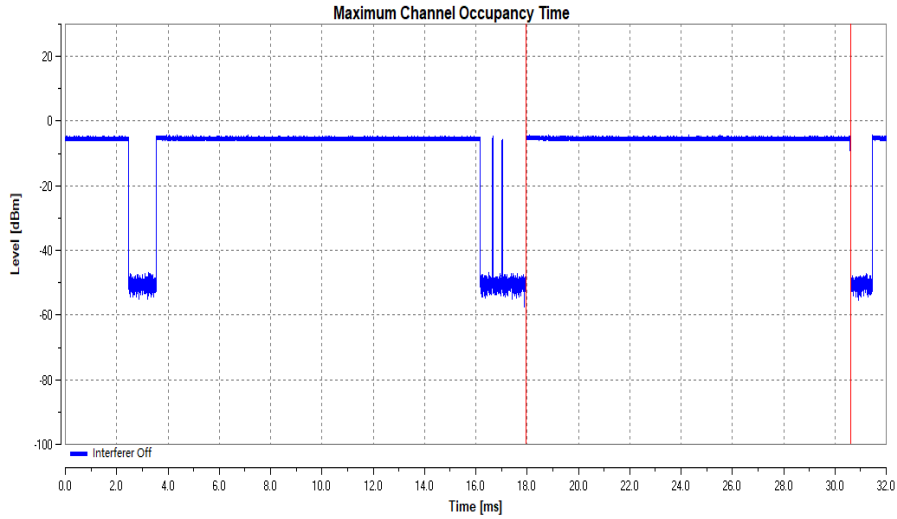

Minimum idle time: 0.08ms

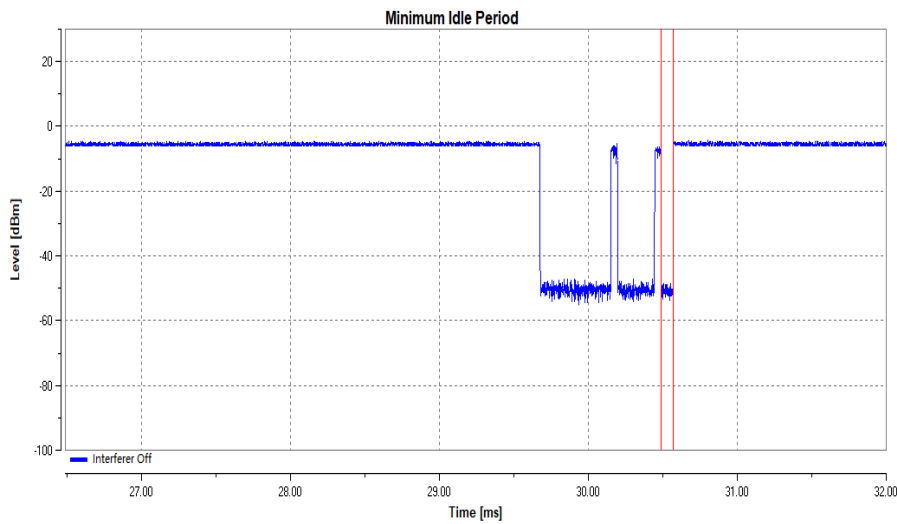



3.6. TRANSMITTER SPURIOUS EMISSIONS

3.6.1. LIMITS OF TRANSMITTER SPURIOUS EMISSIONS

Transmitter limits for narrowband spurious emissions:

Frequency Range	Maximum Power Limit (e.r.p. (≤ 1 GHz) e.i.r.p. (> 1 GHz))	Bandwidth
30 MHz to 47 MHz	-36dBm	100kHz
47 MHz to 74 MHz	-54dBm	100kHz
74 MHz to 87,5 MHz	-36dBm	100kHz
87,5 MHz to 118 MHz	-54dBm	100kHz
118 MHz to 174 MHz	-36dBm	100kHz
174 MHz to 230 MHz	-54dBm	100kHz
230 MHz to 470 MHz	-36dBm	100kHz
470 MHz to 694 MHz	-54dBm	100kHz
694 MHz to 1 GHz	-36dBm	100kHz
1GHz ~ 12.75GHz	-30dBm	1MHz

Note: These limits are e.r.p. for emissions up to 1 GHz and as e.i.r.p. for emissions above 1 GHz.

3.6.2. TEST PROCEDURE

Refer to chapter 5.4.9.2 of ETSI EN 300 328 V2.2.2.

Measurement	
<input type="checkbox"/> Conducted measurement	<input checked="" type="checkbox"/> Radiated measurement
<p>For Conducted measurement:</p> <p>The level of unwanted emissions shall be measured as their power in a specified load (conducted spurious emissions) and their effective radiated power when radiated by the cabinet or structure of the equipment with the antenna connector(s) terminated by a specified load (cabinet radiation).</p>	
<p>Conducted measurement (For equipment with multiple transmit chains):</p> <p><input type="checkbox"/> Option 1: The results for each of the transmit chains for the corresponding 1MHz segments shall be added and compared with the limits.</p> <p><input type="checkbox"/> Option 2: The results for each of the transmit chains shall be individually compared with the limits after these limits have been reduced by $10 \times \log(N)$ (number of active transmit chains)</p>	



3.6.3. DEVIATION FROM TEST STANDARD

No deviation.

3.6.4. TEST SETUP

1. For the actual test configuration, please refer to the related Item in this test report (Photographs of the Test Configuration).
2. The equipment was configured to operate under its worst-case situation with respect to output power.
3. The measurement was performed at normal environmental conditions only. Controlling software has been activated to set the EUT on specific status.
4. This measurement was performed at the lowest and the highest channel.



3.6.5. TEST RESULTS

BELOW 1GHz WORST-CASE DATA

802.11b

FREQUENCY RANGE	30MHz ~ 1GHz	OPERATING CHANNEL	1
------------------------	--------------	--------------------------	---

SPURIOUS EMISSION LEVEL				
Frequency (MHz)	Antenna Polarization	Level (dBm)	Limit (dBm)	Margin (dB)
107.79	H	-71.01	-54.00	-17.01
119.98	H	-70.55	-36.00	-34.55
149.99	H	-76.27	-36.00	-40.27
191.89	H	-76.30	-54.00	-22.30
239.84	H	-62.94	-36.00	-26.94
287.70	H	-75.17	-36.00	-39.17

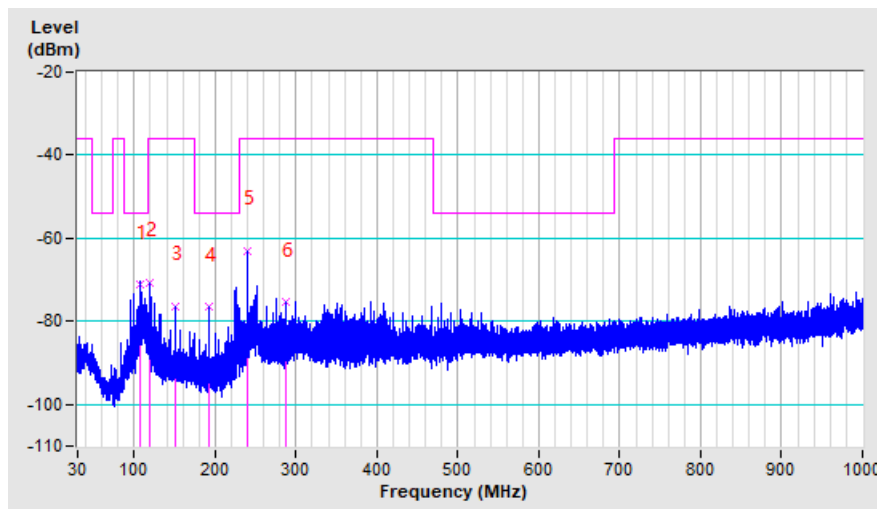



**BUREAU
VERITAS**

Test Report No.: RE2312WDG0148-2

FREQUENCY RANGE	30MHz ~ 1GHz	OPERATING CHANNEL	1
------------------------	--------------	--------------------------	---

SPURIOUS EMISSION LEVEL				
Frequency (MHz)	Antenna Polarization	Level (dBm)	Limit (dBm)	Margin (dB)
107.89	V	-70.57	-54.00	-16.57
119.98	V	-74.26	-36.00	-38.26
149.99	V	-78.17	-36.00	-42.17
240.01	V	-70.86	-36.00	-34.86
264.38	V	-70.95	-36.00	-34.95
397.05	V	-76.81	-36.00	-40.81

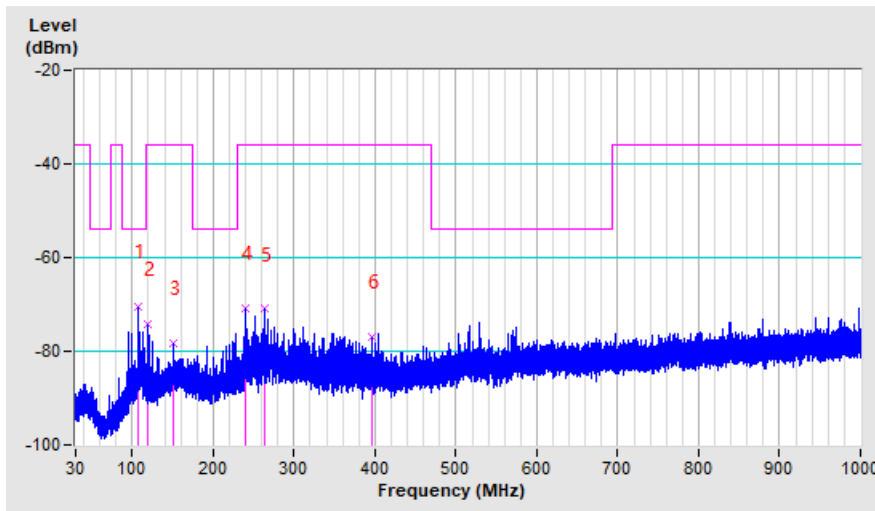



ABOVE 1GHz DATA

802.11b

FREQUENCY RANGE	1GHz ~ 12.75GHz	OPERATING CHANNEL	1, 13
------------------------	-----------------	--------------------------	-------

SPURIOUS EMISSION LEVEL					
Channel	Frequency (MHz)	Antenna Polarization	Level (dBm)	Limit (dBm)	Margin (dB)
1	4824.00	H	-56.00	-30.00	-26.00
	4824.00	V	-56.00	-30.00	-26.00
	7236.00	H	-54.21	-30.00	-24.21
	7236.00	V	-52.22	-30.00	-22.22
13	4944.00	H	-54.95	-30.00	-24.95
	4944.00	V	-55.20	-30.00	-25.20
	7416.00	H	-54.28	-30.00	-24.28
	7416.00	V	-50.56	-30.00	-20.56

802.11g

FREQUENCY RANGE	1GHz ~ 12.75GHz	OPERATING CHANNEL	1, 13
------------------------	-----------------	--------------------------	-------

SPURIOUS EMISSION LEVEL					
Channel	Frequency (MHz)	Antenna Polarization	Level (dBm)	Limit (dBm)	Margin (dB)
1	4824.00	H	-55.72	-30.00	-25.72
	4824.00	V	-55.57	-30.00	-25.57
	7236.00	H	-53.28	-30.00	-23.28
	7236.00	V	-54.32	-30.00	-24.32
13	4944.00	H	-56.97	-30.00	-26.97
	4944.00	V	-55.76	-30.00	-25.76
	7416.00	H	-52.28	-30.00	-22.28
	7416.00	V	-51.51	-30.00	-21.51



802.11n (HT20)

FREQUENCY RANGE	1GHz ~ 12.75GHz	OPERATING CHANNEL	1, 13
------------------------	-----------------	--------------------------	-------

SPURIOUS EMISSION LEVEL					
Channel	Frequency (MHz)	Antenna Polarization	Level (dBm)	Limit (dBm)	Margin (dB)
1	4824.00	H	-56.11	-30.00	-26.11
	4824.00	V	-54.95	-30.00	-24.95
	7236.00	H	-53.80	-30.00	-23.80
	7236.00	V	-52.13	-30.00	-22.13
13	4944.00	H	-54.90	-30.00	-24.90
	4944.00	V	-55.65	-30.00	-25.65
	7416.00	H	-53.26	-30.00	-23.26
	7416.00	V	-52.38	-30.00	-22.38



RECEIVER PARAMETERS

3.7. RECEIVER SPURIOUS RADIATION

3.7.1. LIMITS OF RECEIVER SPURIOUS RADIATION

Frequency Range	Maximum Power Limit (e.r.p. (≤ 1 GHz) e.i.r.p. (> 1 GHz))
30MHz ~ 1GHz	-57dBm
1GHz ~ 12.75GHz	-47dBm

Note: These limits are e.r.p. for emissions up to 1 GHz and as e.i.r.p. for emissions above 1 GHz.

3.7.2. TEST PROCEDURE

Refer to chapter 5.4.10.2 of ETSI EN 300 328 V2.2.2.

Measurement	
<input type="checkbox"/> Conducted measurement	<input checked="" type="checkbox"/> Radiated measurement
<p>For Conducted measurement: The level of unwanted emissions shall be measured as their power in a specified load (conducted spurious emissions) and their effective radiated power when radiated by the cabinet or structure of the equipment with the antenna connector(s) terminated by a specified load (cabinet radiation).</p>	
<p>Conducted measurement (For equipment with multiple transmit chains):</p> <p><input type="checkbox"/> Option 1: The results for each of the transmit chains for the corresponding 1MHz segments shall be added and compared with the limits.</p> <p><input type="checkbox"/> Option 2: The results for each of the transmit chains shall be individually compared with the limits after these limits have been reduced by $10 \times \log(N)$ (number of active transmit chains)</p>	

3.7.3. DEVIATION FROM TEST STANDARD

No deviation.

3.7.4. TEST SETUP

1. For the actual test configuration, please refer to the related Item in this test report (Photographs of the Test Configuration).
2. Testing was performed when the equipment was in a receive-only mode.
3. The measurement was performed at normal environmental conditions only. Controlling software has been activated to set the EUT on specific status.
4. This measurement was performed at the lowest and the highest channel.



3.7.5. TEST RESULTS

RX BELOW 1GHz WORST-CASE DATA

FREQUENCY RANGE	30MHz ~ 1GHz	OPERATING CHANNEL	1
------------------------	--------------	--------------------------	---

SPURIOUS EMISSION LEVEL				
Frequency (MHz)	Antenna Polarization	Level (dBm)	Limit (dBm)	Margin (dB)
107.92	H	-65.98	-57.00	-8.98
119.98	H	-67.44	-57.00	-10.44
149.99	H	-70.01	-57.00	-13.01
239.97	H	-66.40	-57.00	-9.40
275.86	H	-66.73	-57.00	-9.73
503.97	H	-67.23	-57.00	-10.23

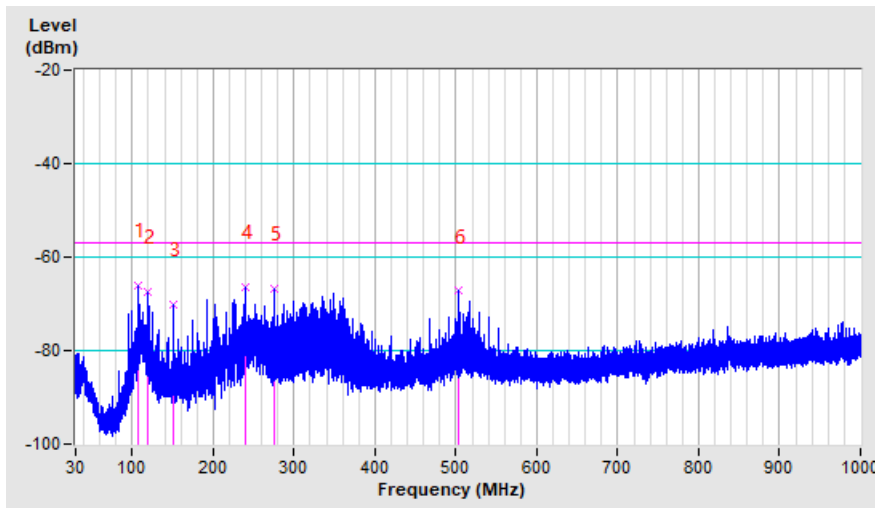



**BUREAU
VERITAS**

Test Report No.: RE2312WDG0148-2

FREQUENCY RANGE	30MHz ~ 1GHz	OPERATING CHANNEL	1
------------------------	--------------	--------------------------	---

SPURIOUS EMISSION LEVEL				
Frequency (MHz)	Antenna Polarization	Level (dBm)	Limit (dBm)	Margin (dB)
191.96	V	-71.72	-57.00	-14.72
252.19	V	-74.51	-57.00	-17.51
263.96	V	-67.46	-57.00	-10.46
300.05	V	-75.23	-57.00	-18.23
369.01	V	-73.39	-57.00	-16.39
570.58	V	-72.79	-57.00	-15.79

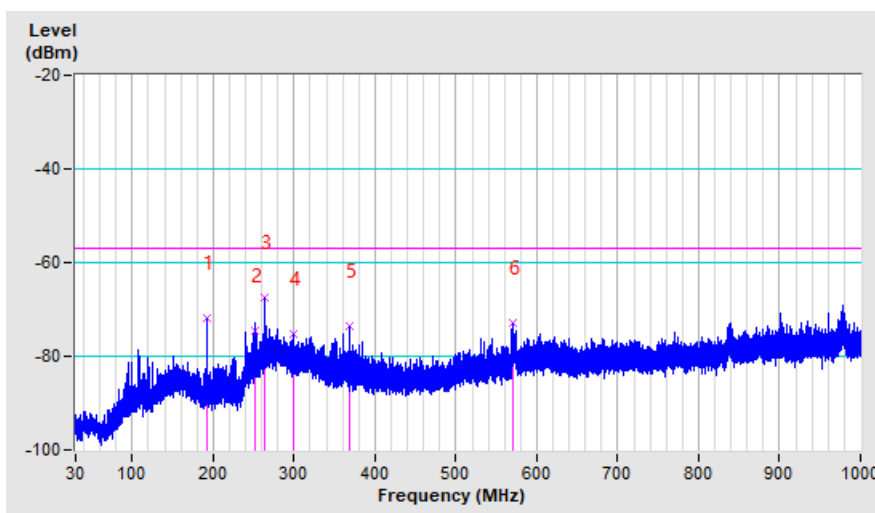



RX ABOVE 1GHz WORST-CASE DATA

FREQUENCY RANGE	1GHz ~ 12.75GHz	OPERATING CHANNEL	1, 13
------------------------	-----------------	--------------------------	-------

SPURIOUS EMISSION LEVEL					
Channel	Frequency (MHz)	Antenna Polarization	Level (dBm)	Limit (dBm)	Margin (dB)
1	4824.00	H	-56.80	-47.00	-9.80
	4824.00	V	-57.22	-47.00	-10.22
	7236.00	H	-59.36	-47.00	-12.36
	7236.00	V	-58.11	-47.00	-11.11
13	4944.00	H	-58.74	-47.00	-11.74
	4944.00	V	-58.44	-47.00	-11.44
	7436.00	H	-55.49	-47.00	-8.49
	7436.00	V	-58.25	-47.00	-11.25



3.8. RECEIVER BLOCKING

3.8.1. LIMITS OF RECEIVER BLOCKING

This requirement applies to all receiver categories.

Receiver Category		
<input checked="" type="checkbox"/> Category 1(EIRP>10dBm)	<input type="checkbox"/> Category 2(EIRP ≤ 10dBm)	<input type="checkbox"/> Category 3(EIRP ≤ 0dBm)
Minimum performance criterion	<input checked="" type="checkbox"/> PER ≤ 10%	
	<input type="checkbox"/> Alternative performance criteria (See note)	
Note: The manufacturer was declared the minimum performance criterion shall be no loss of the wireless transmission function needed for the intended use of the equipment.		

Receiver Category 1 Equipment			
Wanted signal mean power from companion device (dBm)(See note 1 and 4)	Blocking Signal Frequency (MHz)	Blocking Signal Power (dBm) (See note 4)	Type of blocking signal
(-133dBm+10xlog ₁₀ (OCBW) Or -68dBm whichever is less (See note 2)	2 380	-34	CW
	2 504		
(-139dBm+10xlog ₁₀ (OCBW) Or -74dBm whichever is less (See note 3)	2 300		
	2 330		
	2 360		
	2 524		
	2 584		
	2 674		
<p>NOTE 1: OCBW is in Hz.</p> <p>NOTE 2: In case of radiated measurements using a companion device and the level of the wanted signal from the companion device cannot be determined, a relative test may be performed using a wanted signal up to P_{min} + 26 dB where P_{min} is the minimum level of wanted signal required to meet the minimum performance criteria as defined in clause 4.3.1.12.3 in the absence of any blocking signal.</p> <p>NOTE 3: In case of radiated measurements using a companion device and the level of the wanted signal from the companion device cannot be determined, a relative test may be performed using a wanted signal up to P_{min} + 20 dB where P_{min} is the minimum level of wanted signal required to meet the minimum performance criteria as defined in clause 4.3.1.12.3 in the absence of any blocking signal.</p> <p>NOTE 4: The level specified is the level at the UUT receiver input assuming a 0 dBi antenna assembly gain. In case of conducted measurements, this level has to be corrected for the (in-band) antenna assembly gain (G). In case of radiated measurements, this level is equivalent to a power flux density (PFD) in front of the UUT antenna with the UUT being configured/positioned as recorded in clause 5.4.3.2.2.</p>			



Receiver Category 2 Equipment			
Wanted signal mean power from companion device (dBm)(See note 1 and 3)	Blocking Signal Frequency (MHz)	Blocking Signal Power (dBm) (See note 3)	Type of blocking signal
(-139dBm+10xlog ₁₀ (OCBW)+10dB) Or -74dBm+10dB whichever is less(See note 2)	2 380	-34	CW
	2 504		
	2 300		
	2 584		
<p>NOTE 1: OCBW is in Hz.</p> <p>NOTE 2: In case of radiated measurements using a companion device and the level of the wanted signal from the companion device cannot be determined, a relative test may be performed using a wanted signal up to P_{min} + 26 dB where P_{min} is the minimum level of wanted signal required to meet the minimum performance criteria as defined in clause 4.3.1.12.3 in the absence of any blocking signal.</p> <p>NOTE 3: The level specified is the level at the UUT receiver input assuming a 0 dBi antenna assembly gain. In case of conducted measurements, this level has to be corrected for the (in-band) antenna assembly gain (G). In case of radiated measurements, this level is equivalent to a power flux density (PFD) in front of the UUT antenna with the UUT being configured/positioned as recorded in clause 5.4.3.2.2.</p>			

Receiver Category 3 Equipment			
Wanted signal mean power from companion device (dBm) (See note 1 and 3)	Blocking Signal Frequency (MHz)	Blocking Signal Power (dBm) (See note 3)	Type of blocking signal
(-139dBm+10xlog ₁₀ (OCBW)+20dB) Or -74dBm+20dB whichever is less(See note 2)	2 380	-34	CW
	2 504		
	2 300		
	2 584		
<p>NOTE 1: OCBW is in Hz.</p> <p>NOTE 2: In case of radiated measurements using a companion device and the level of the wanted signal from the companion device cannot be determined, a relative the test may be performed using a wanted signal up to P_{min} + 30 dB where P_{min} is the minimum level of wanted signal required to meet the minimum performance criteria as defined in clause 4.3.1.12.3 in the absence of any blocking signal.</p> <p>NOTE 3: The level specified is the level at the UUT receiver input assuming a 0 dBi antenna assembly gain. In case of conducted measurements, this level has to be corrected for the (in-band) antenna assembly gain (G). In case of radiated measurements, this level is equivalent to a power flux density (PFD) in front of the UUT antenna with the UUT being configured/positioned as recorded in clause 5.4.3.2.2.</p>			

3.8.2. TEST PROCEDURE

Refer to chapter 5.4.11.2. of ETSI EN 300 328 V2.2.2.

Measurement	
<input checked="" type="checkbox"/> Conducted measurement	<input type="checkbox"/> Radiated measurement

3.8.3. DEVIATION FROM TEST STANDARD

No deviation.



3.8.4. TEST SETUP CONFIGURATION

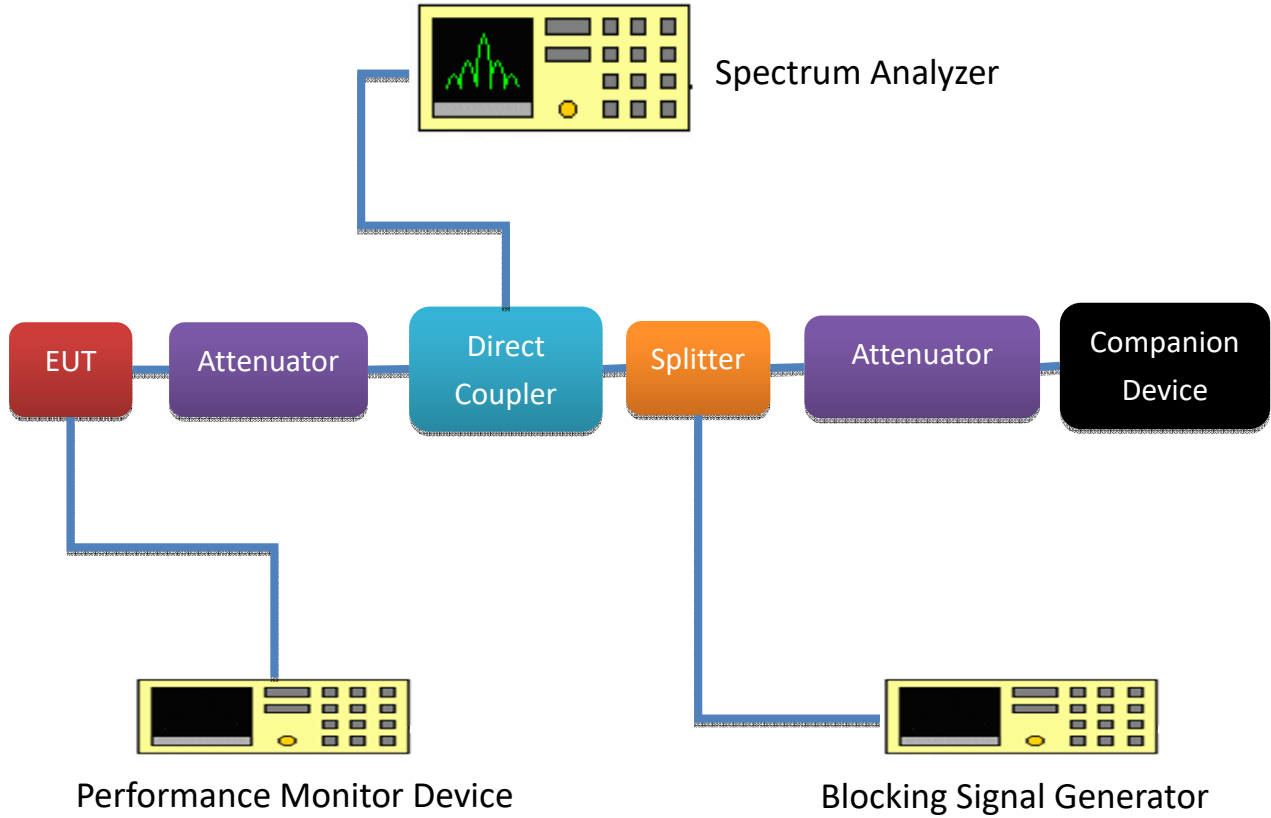



3.8.5. TEST RESULT

802.11b

Receiver Category 1 Equipment

Receiver blocking performance when operating at the lowest operating channel(CH1)				
OCBW _{min} : 14.88MHz		antenna gain(G) : 3dBi		
The actual blocking signal power(Note1)		<input checked="" type="checkbox"/> at the antenna connector		
		<input type="checkbox"/> in front of the antenna		
Note1: For the conducted measurements , the level shall be corrected as follows: the actual blocking signal power = blocking signal power + antenna gain				
The actual wanted signal mean power from companion device (dBm)	Blocking signal frequency (MHz)	The actual blocking signal power (dBm)	PER(%)	Pass/Fail
-65	2380	-31	0.5	PASS
-71	2300		0.5	PASS
	2330		0.2	PASS
	2360		0.1	PASS

Receiver blocking performance when operating at the lowest operating channel(CH13)				
OCBW _{min} : 15.04MHz		antenna gain(G) : 3dBi		
The actual blocking signal power(Note1)		<input checked="" type="checkbox"/> at the antenna connector		
		<input type="checkbox"/> in front of the antenna		
Note1: For the conducted measurements , the level shall be corrected as follows: the actual blocking signal power = blocking signal power + antenna gain				
The actual wanted signal mean power from companion device (dBm)	Blocking signal frequency (MHz)	The actual blocking signal power (dBm)	PER(%)	Pass/Fail
-65	2504	-31	0.1	PASS
-71	2524		0.4	PASS
	2584		0.1	PASS
	2674		0.3	PASS



4 PHOTOGRAPHS OF THE TEST CONFIGURATION

SPURIOUS EMISSION TEST BELOW 1GHz

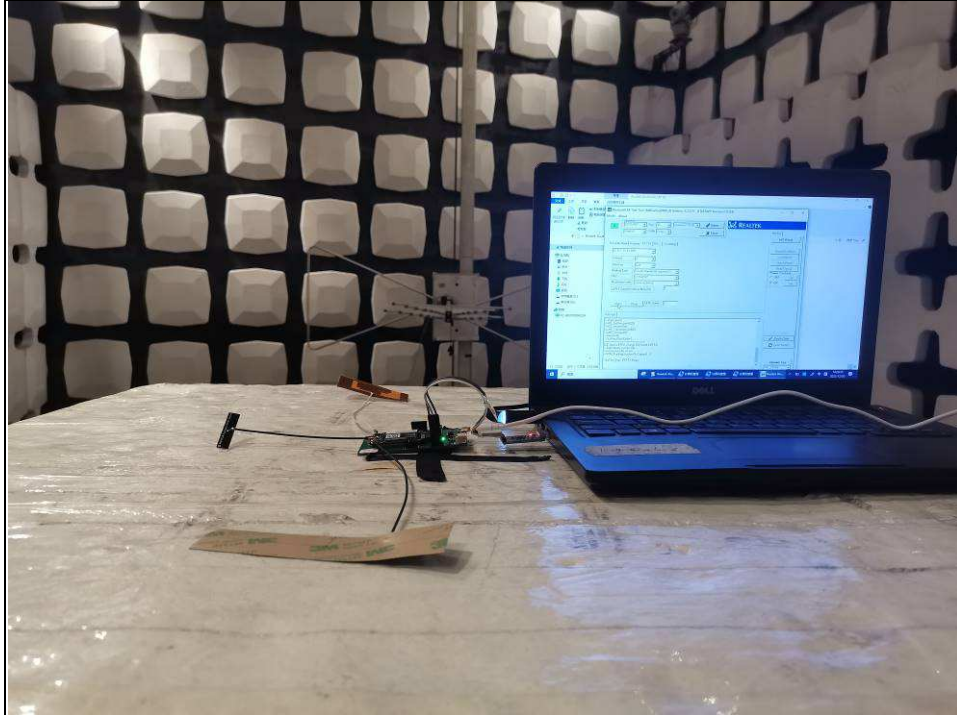

SPURIOUS EMISSION TEST ABOVE 1GHz

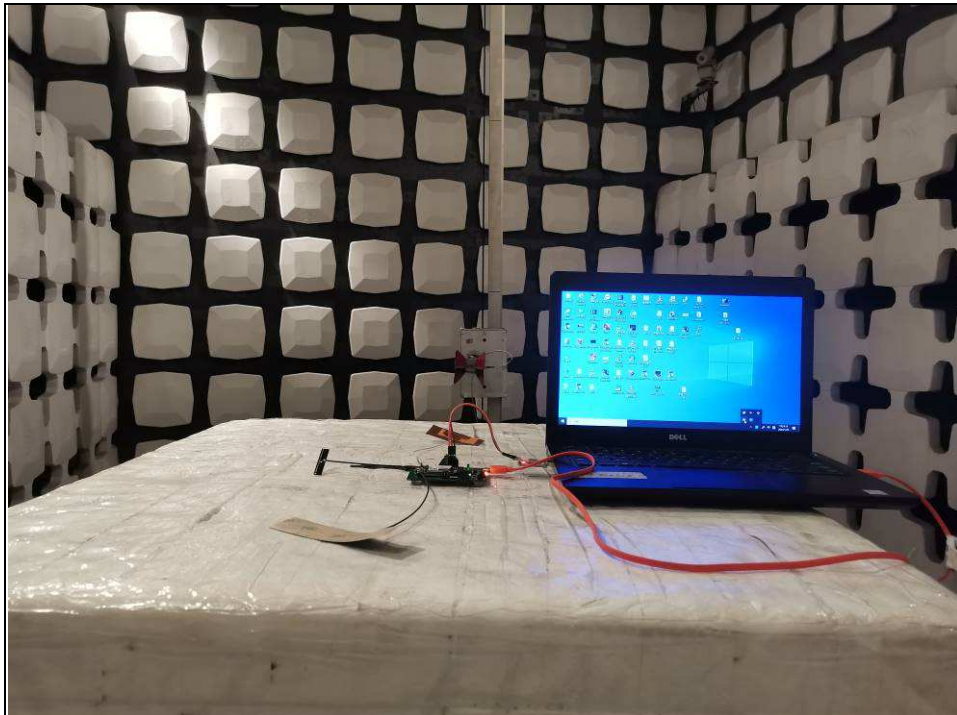



ADAPTIVITY TEST



RECEIVING BLOCKING





BUREAU
VERITAS

Test Report No.: RE2312WDG0148-2

5 APPENDIX A – MODIFICATIONS RECORDERS FOR ENGINEERING CHANGES TO THE EUT BY THE LAB

No modifications were made to the EUT by the lab during the test.

--- END ---