

IC TEST REPORT

(RSS-130)



Applicant:	Particle Industries, Inc
Address:	325 9th Street, San Francisco, CA 94103, United States Of America

Manufacturer or Supplier:	Particle Industries, Inc
Address:	325 9th Street, San Francisco, CA 94103, United States Of America
Product:	Montior One DE
Brand Name:	Particle
Model Name:	MON404-DE
IC:	20127-MONEDE
Date of tests:	Oct. 11, 2023 ~ Oct. 20, 2023

The tests have been carried out according to the requirements of the following standard:

- RSS-130 Issue 2, February 2019**
- RSS-Gen Issue 5, Amendment 1, March 2019**
- ANSI C63.26-2015**

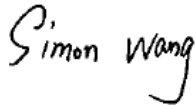
CONCLUSION: The submitted sample was found to COMPLY with the test requirement

Prepared by Simon Wang Engineer / Mobile Department	Approved by Luke Lu Manager / Mobile Department
	
Date: Oct. 20, 2023	Date: Oct. 20, 2023

This report is governed by, and incorporates by reference, the Conditions of Testing as posted at the date of issuance of this report at <http://www.bureauveritas.com/home/about-us/our-business/cps/about-us/terms-conditions>, and is intended for your exclusive use. Any copying or replication of this report to or for any other person or entity, or use of our name or trademark, is permitted only with our prior written permission. This report sets forth our findings solely with respect to the test samples identified herein. The results set forth in this report are not indicative or representative of the quality or characteristics of the lot from which a test sample was taken or any similar or identical product unless specifically and expressly noted. Our report includes all of the tests requested by you and the results thereof based upon the information that you provided to us. Measurement uncertainty is only provided upon request for accredited tests. Statements of conformity are based on simple acceptance criteria without taking measurement uncertainty into account, unless otherwise requested in writing. You have 60 days from date of issuance of this report to notify us of any material error or omission caused by our negligence or if you require measurement uncertainty; provided, however, that such notice shall be in writing and shall specifically address the issue you wish to raise. A failure to raise such issue within the prescribed time shall constitute your unqualified acceptance of the completeness of this report, the tests conducted and the correctness of the report contents.



TABLE OF CONTENTS

RELEASE CONTROL RECORD 4

1 SUMMARY OF TEST RESULTS 5

1.1 MEASUREMENT UNCERTAINTY 6

1.2 TEST SITE AND INSTRUMENTS 7

2 GENERAL INFORMATION..... 8

2.1 GENERAL DESCRIPTION OF EUT 8

2.2 CONFIGURATION OF SYSTEM UNDER TEST 11

2.3 DESCRIPTION OF SUPPORT UNITS 12

2.4 DESCRIPTION OF TEST MODES..... 12

2.5 GENERAL DESCRIPTION OF APPLIED STANDARDS 15

2.6 TRANSMIT ANTENNA..... 15

3 TEST TYPES AND RESULTS 16

3.1 OUTPUT POWER MEASUREMENT 16

3.1.1 LIMITS OF OUTPUT POWER MEASUREMENT 16

3.1.2 TEST PROCEDURES 16

3.1.3 TEST SETUP 17

3.1.4 TEST RESULTS 18

3.2 FREQUENCY STABILITY MEASUREMENT 24

3.2.1 LIMITS OF FREQUENCY STABILITY MEASUREMENT 24

3.2.2 TEST PROCEDURE 24

3.2.3 TEST SETUP 24

3.2.4 TEST RESULTS 25

3.3 OCCUPIED BANDWIDTH MEASUREMENT 26

3.3.1 LIMITS OF OCCUPIED BANDWIDTH MEASUREMENT 26

3.3.2 TEST SETUP 26

3.3.3 TEST PROCEDURES 26

3.3.4 TEST RESULTS 27

3.4 PEAK TO AVERAGE RATIO 28

3.4.1 LIMITS OF PEAK TO AVERAGE RATIO MEASUREMENT 28

3.4.2 TEST SETUP 28

3.4.3 TEST PROCEDURES 28

3.4.4 TEST RESULTS 29

3.5 BAND EDGE MEASUREMENT 30

3.5.1 LIMITS OF BAND EDGE MEASUREMENT 30

3.5.2 TEST SETUP 30

3.5.3 TEST PROCEDURES 31

3.5.4 TEST RESULTS 32

3.6 CONDUCTED SPURIOUS EMISSIONS..... 33

3.6.1 LIMITS OF CONDUCTED SPURIOUS EMISSIONS MEASUREMENT 33

3.6.2 TEST PROCEDURE 33

3.6.3 TEST SETUP 34

3.6.4 TEST RESULTS 35

3.7 RADIATED EMISSION MEASUREMENT 36

3.7.1 LIMITS OF RADIATED EMISSION MEASUREMENT 36

3.7.2 TEST PROCEDURES 36

3.7.3 DEVIATION FROM TEST STANDARD 36

3.7.4 TEST SETUP 37

3.7.5 TEST RESULTS 39



Test Report No.: W7L-P23100004R101

4	INFORMATION ON THE TESTING LABORATORIES	61
5	MODIFICATIONS RECORDERS FOR ENGINEERING CHANGES TO THE EUT BY THE LAB	62



BUREAU
VERITAS

Test Report No.: W7L-P23100004RI01

RELEASE CONTROL RECORD

ISSUE NO.	REASON FOR CHANGE	DATE ISSUED
W7L-P23100004RI01	Original release	Oct. 20, 2023



1 SUMMARY OF TEST RESULTS

The EUT has been tested according to the following specifications:

APPLIED STANDARD: IC RSS-130, RSS-Gen		
STANDARD SECTION	TEST TYPE AND LIMIT	RESULT
RSS-Gen		
6.7	Occupied Bandwidth	See Note
6.8	Transmit antenna	Compliance
STANDARD SECTION	TEST TYPE AND LIMIT	RESULT
RSS-130		
4.5	Frequency Stability AFC Freq. Error vs. Voltage AFC Freq. Error vs. Temperature	See Note
4.6	Maximum Peak Output Power	Compliance
4.6	peak-to-average power ratio	See Note
4.7	Band Edge Measurements	See Note
4.7	Conducted Spurious Emissions	See Note
4.7	Radiated Spurious Emissions	Compliance

NOTE: Refer to Module report R1811A0536-R9, IC:10224A-201709BG96.



1.1 MEASUREMENT UNCERTAINTY

Where relevant, the following measurement uncertainty levels have been estimated for tests performed on the EUT as specified in ETSI TR 100 028-1 V1.4.1(2001-12):

MEASUREMENT	UNCERTAINTY
Frequency Stability	$\pm 76.97\text{Hz}$
Radiated emissions (9KHz~30MHz)	$\pm 2.68\text{dB}$
Radiated emissions & Radiated Power (30MHz~1GHz)	$\pm 4.98\text{dB}$
Radiated emissions & Radiated Power (1GHz ~6GHz)	$\pm 4.70\text{dB}$
Radiated emissions (6GHz ~18GHz)	$\pm 4.60\text{dB}$
Radiated emissions (18GHz ~40GHz)	$\pm 4.12\text{dB}$
Conducted emissions	$\pm 4.01\text{dB}$
Occupied Channel Bandwidth	$\pm 43.58\text{KHz}$
Conducted Output power	$\pm 2.06\text{dB}$
Band Edge Measurements	$\pm 4.70\text{dB}$
Peak to average ratio	$\pm 0.76\text{dB}$

This uncertainty represents an expanded uncertainty expressed at approximately the 95% confidence level using a coverage factor of $k=2$.



1.2 TEST SITE AND INSTRUMENTS

Equipment	Manufacturer	Model No.	Serial No.	Last Cal.	Next Cal.
MXE EMI Receiver	KEYSIGHT	N9038A-544	MY54450026	Mar. 28,23	Mar. 27,24
EXA Signal Analyzer	KEYSIGHT	N9010A-544	MY54510355	May.10,23	May.09,24
Loop Antenna	Schwarzbeck	FMZB 1519B	00173	Sep.02,23	Sep.01,24
Bilog Antenna	ETS-LINDGRE N	3143B	00161965	Feb. 18,23	Feb. 17,24
Horn Antenna	ETS-LINDGRE N	3117	00168692	Feb. 18,23	Feb. 17,24
Horn Antenna (18GHz-40GHz)	N/A	QWH-SL-18-40-K- SG/QMS-00361	15433	Sep.03, 23	Sep.02, 24
Radio Communication Analyzer	ANRITSU	MT8820C	6201465426	Feb. 14,23	Feb. 13,24
Signal Pre-Amplifier	EMSI	EMC 9135	980249	May. 06,23	May. 05,24
Signal Pre-Amplifier	EMSI	EMC 012645B	980257	May.10,23	May.09,24
Signal Pre-Amplifier	EMSI	EMC 184045B	980259	Feb. 17,23	Feb.16,24
3m Semi-anechoic Chamber	ETS-LINDGRE N	9m*6m*6m	Euroshieldpn- CT0001143-121 6	May. 22, 23	May. 21,26
Test Software	E3	V 9.160323	N/A	N/A	N/A
Test Software	JS1120	3.1.36	N/A	N/A	N/A
10dB Attenuator	JFW/USA	50HF-010-SMA	50HF-010-SMA	May. 06,23	May. 05,24
Power Meter	Anritsu	ML2495A	1506002	Feb. 14,23	Feb. 13,24
Power Sensor	Anritsu	MA2411B	1339352	Feb. 14,23	Feb. 13,24
Temperature Chamber	ESPEC	SH-242	93000855	May. 06,23	May. 05,24
MXG Analog Microvave Signal Generator	KEYSIGHT	N5183A	MY50143024	Feb. 14,23	Feb. 13,24
Base station R&S CMW500	Rohde&Schwa rz	CMW500	153085	May.10,23	May.09,24
DC Source	Kikusui/JP	PMX18-5A	N/A	Aug. 11,23	Aug. 10,24

- NOTE:**
1. The calibration interval of the above test instruments is 12 months months and the calibrations are traceable to CEPREI/CHINA, GRGT/CHINA and NIM/CHINA.
 2. The test was performed in 3m Semi-anechoic Chamber and RF Oven Room.
 3. The horn antenna is used only for the measurement of emission frequency above 1GHz if tested.
 4. The IC Company Number is 21771; The CAB Identifier No. is CN0007.



2 GENERAL INFORMATION

2.1 GENERAL DESCRIPTION OF EUT

EUT	Montior One DE	
BRAND NAME	Particle	
MODEL NAME	MON404-DE	
POWER SUPPLY	24Vdc (adapter or host equipment) 3.7Vdc (Li-ion, battery)	
MODULATION TECHNOLOGY	LTE CAT-M1	QPSK, 16QAM
FREQUENCY RANGE	LTE Band 12 Channel Bandwidth: 1.4MHz	699.7MHz ~ 715.3MHz
	LTE Band 12 Channel Bandwidth: 3MHz	700.5MHz ~ 714.5MHz
	LTE Band 12 Channel Bandwidth: 5MHz	701.5MHz ~ 713.5MHz
	LTE Band 12 Channel Bandwidth: 10MHz	704.0MHz ~ 711.0MHz
	LTE Band 13 Channel Bandwidth: 5MHz	779.5MHz ~ 784.5MHz
	LTE Band 13 Channel Bandwidth: 10MHz	782.0MHz
EMISSION DESIGNATOR	LTE Band 12 Channel Bandwidth: 1.4MHz	QPSK: 1M11G7D
		16QAM: 939KW7D
		64QAM: /
	LTE Band 12 Channel Bandwidth: 3MHz	QPSK: 1M15G7D
		16QAM: 985KW7D
		64QAM: /
	LTE Band 12 Channel Bandwidth: 5MHz	QPSK: 1M14G7D
		16QAM: 976KW7D
		64QAM: /



EMISSION DESIGNATOR	LTE Band 12 Channel Bandwidth: 10MHz	QPSK: 1M21G7D
		16QAM: 1M08W7D
		64QAM: /
	LTE Band 13 Channel Bandwidth: 5MHz	QPSK: 1M15G7D
		16QAM: 977KW7D
		64QAM: /
	LTE Band 13 Channel Bandwidth: 10MHz	QPSK: 1M18G7D
		16QAM: 1M03W7D
		64QAM: /
MAX. ERP/EIRP POWER	LTE Band 12 Channel Bandwidth: 1.4MHz	167.11mW
	LTE Band 12 Channel Bandwidth: 3MHz	166.34mW
	LTE Band 12 Channel Bandwidth: 5MHz	168.27mW
	LTE Band 12 Channel Bandwidth: 10MHz	169.82mW
	LTE Band 13 Channel Bandwidth: 5MHz	187.07mW
	LTE Band 13 Channel Bandwidth: 10MHz	187.93mW
ANTENNA TYPE	Fixed External Antenna with 1.7dBi gain for LTE B12 Fixed External Antenna with 1.7dBi gain for LTE B13	
HW VERSION	v1.2.0	
SW VERSION	v4.0.2	
I/O PORTS	Refer to user's manual	
CABLE SUPPLIED	Cable 1: non-shielded cable, with w/o ferrite core, 1.5 meter Cable 2: non-shielded cable, with w/o ferrite core, 1.5 meter	
EXTREME TEMPERATURE	-10~60 °C	
EXTREME VOLTAGE	3.6V - 4.2V	

NOTE:

1. For a more detailed features description, please refer to the manufacturer's specifications or the user's manual.
2. The EUT incorporates a SISO function. Physically, the EUT provides one completed transmitter and one receiver.

MODULATION MODE	TX FUNCTION
LTE	1TX/1RX

3. For the test results, the EUT had been tested with all conditions. But only the worst case was shown in test report.



List of Accessory:

ACCESSORIES	BRAND	MANUFACTURER	MODEL	SPECIFICATION
Battery	Guangdong Zhaoneng	Guangdong Zhaoneng	ZN18650-4P	Capacity: 3.7Vdc, 12200mAh
AC Adapter	TRI-MAG	TRI-MAG LLC	L6R30-240	I/P: 100-240Vac, 0.8A, O/P: 24Vdc, 1.25A
Cable 1	KAWEEI	KAWEEI technology	CBH-M12M-04 -1500	Signal Line,1.5meter
Cable 2	KAWEEI	KAWEEI technology	115-00014 CBH-M12M-08 -1500	Signal Line,1.5meter



2.2 CONFIGURATION OF SYSTEM UNDER TEST

FOR RADIATION EMISSION TEST

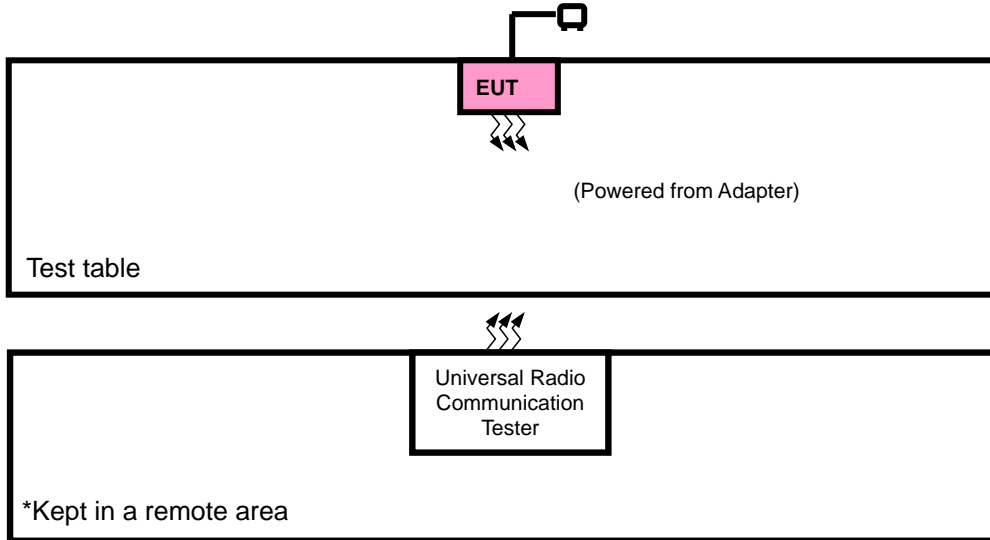



2.3 DESCRIPTION OF SUPPORT UNITS

The EUT has been tested as an independent unit together with other necessary accessories or support units. The following support units or accessories were used to form a representative test configuration during the tests.

NO.	PRODUCT	BRAND	MODEL NO.	SERIAL NO.	FCC ID
1	Adapter	Jingsai	CLS-050200	NA	N/A

NO.	SIGNAL CABLE DESCRIPTION OF THE ABOVE SUPPORT UNITS
1	N/A

2.4 DESCRIPTION OF TEST MODES

Pre-Scan has been conducted to determine the worst-case mode from all possible combinations between available modulations, data rates, XYZ axis and antenna ports. The worst case was found when positioned on Y-plane for ERP and X-axis for radiated emission. Following channel(s) was (were) selected for the final test as listed below:

EUT CONFIGURE MODE	DESCRIPTION
A	EUT + Adapter with LTE link



LTE BAND 12 MODE

EUT CONFIGURE MODE	TEST ITEM	AVAILABLE CHANNEL	TESTED CHANNEL	CHANNEL BANDWIDTH	MODULATION	MODE
A	ERP	23017 to 23173	23017, 23095, 23173	1.4MHz	QPSK, 16QAM	1 RB / 0 RB Offset
		23025 to 23165	23025, 23095 ,23165	3MHz	QPSK, 16QAM	1 RB / 0 RB Offset
		23035 to 23155	23035, 23095 ,23155	5MHz	QPSK, 16QAM	1 RB / 0 RB Offset
		23060 to 23130	23060, 23095 ,23130	10MHz	QPSK, 16QAM	1 RB / 0 RB Offset
A	RADIATED EMISSION	23017 to 23173	23017, 23095 ,23173	1.4MHz	QPSK	1 RB / 0 RB Offset
		23025 to 23165	23095	3MHz	QPSK	1 RB / 0 RB Offset
		23035 to 23155	23095	5MHz	QPSK	1 RB / 0 RB Offset
		23060 to 23130	23095	10MHz	QPSK	1 RB / 0 RB Offset

Note: This device was tested under all bandwidths, RB configurations and modulations. The worst case was found in QPSK modulation.

LTE BAND 13 MODE

EUT CONFIGURE MODE	TEST ITEM	AVAILABLE CHANNEL	TESTED CHANNEL	CHANNEL BANDWIDTH	MODULATION	MODE
A	ERP	23205 to 23255	23205, 23230, 23255	5MHz	QPSK, 16QAM	1 RB / 0 RB Offset
		23230	23230	10MHz	QPSK, 16QAM	1 RB / 0 RB Offset
A	RADIATED EMISSION	23205 to 23255	23205, 23230, 23255	5MHz	QPSK	1 RB / 0 RB Offset
		23230	23230	10MHz	QPSK	1 RB / 0 RB Offset

Note: This device was tested under all bandwidths, RB configurations and modulations. The worst case was found in QPSK modulation.



TEST CONDITION:

TEST ITEM	ENVIRONMENTAL CONDITIONS	INPUT POWER	TESTED BY
ERP	24deg. C, 60%RH	DC 24V By Adapter	Jace Hu
RADIATED EMISSION	23deg. C, 70%RH	DC 24V By Adapter	Jace Hu



2.5 GENERAL DESCRIPTION OF APPLIED STANDARDS

The EUT is a RF product. According to the specifications of the manufacturer, it must comply with the requirements of the following standards:

Canada RSS-130, Issue 2, February 2019

Canada RSS-Gen, Issue 5, Amendment 1, March 2019

ANSI C63.26 - 2015

NOTE: All test items have been performed and recorded as per the above standards.

2.6 TRANSMIT ANTENNA

The applicant for equipment certification shall provide a list of all antenna types that may be used with the transmitter, where applicable (i.e. for transmitters with detachable antenna), indicating the maximum permissible antenna gain (in dBi) and the required impedance for each antenna. The test report shall demonstrate the compliance of the transmitter with the limit for maximum equivalent isotropically radiated power (e.i.r.p.) specified in the applicable RSS, when the transmitter is equipped with any antenna type, selected from this list.

Antenna Type	Fixed External antenna
Antenna Gain	1.7dBi gain for LTE B12 1.7dBi gain for LTE B13
Impedance	50 Ω



3 TEST TYPES AND RESULTS

3.1 OUTPUT POWER MEASUREMENT

3.1.1 LIMITS OF OUTPUT POWER MEASUREMENT

For frequency bands 617-652MHz and 663-698MHz:

The e.r.p. shall not exceed 3 watts for mobile equipment, fixed subscriber equipment and portable equipment.

For frequency bands 698-756MHz and 777-787MHz:

The e.r.p. shall not exceed 30 watts for mobile equipment and outdoor fixed subscriber equipment. The e.r.p. shall not exceed 3 watts for portable equipment and indoor fixed subscriber equipment.

3.1.2 TEST PROCEDURES

ERP MEASUREMENT:

Per KDB 971168 D01 Power Meas License Digital Systems v03r01 or subclause 5.2.5.5 of ANSI C63.26-2015, the relevant equation for determining the ERP or EIRP from the conducted RF output power measured using the guidance provided above is:

$$\text{ERP or EIRP} = P_{\text{Meas}} + G_{\text{T}} - L_{\text{C}}$$

Where:

ERP or EIRP = effective radiated power or equivalent isotropically radiated power, respectively

(expressed in the same units as P_{Meas} , typically dBW or dBm);

P_{Meas} = measured transmitter output power or PSD, in dBm or dBW;

G_{T} = gain of the transmitting antenna, in dBd (ERP) or dBi (EIRP);

L_{C} = signal attenuation in the connecting cable between the transmitter and antenna, in dB.

$$\text{ERP} = \text{EIRP} - 2.15$$

CONDUCTED POWER MEASUREMENT:

- The EUT was set up for the maximum power with LTE link data modulation and link up with simulator.
- Set the EUT to transmit under low, middle and high channel and record the power level shown on simulator.



3.1.3 TEST SETUP

CONDUCTED POWER MEASUREMENT:

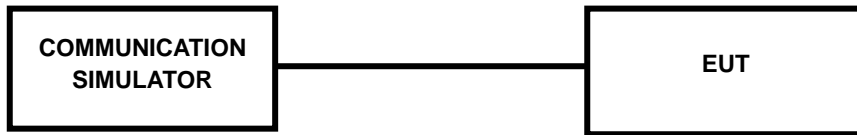



3.1.4 TEST RESULTS

CONDUCTED OUTPUT POWER (dBm)

LTE Band 12

Band/BW	Modulation	RB Size	RB Offset	Low CH 23017	Mid CH 23095	High CH 23173
				Frequency 699.7 MHz	Frequency 707.5 MHz	Frequency 715.3 MHz
12/ 1.4	QPSK	1	0	22.40	22.68	22.47
		1	5	22.43	22.56	22.45
		3	0	22.47	22.52	22.43
		3	3	22.42	22.46	22.29
		6	0	22.55	22.65	22.51
	16QAM	1	0	22.53	22.64	22.53
		1	5	22.52	22.50	22.41
		3	0	22.50	22.60	22.47
		3	3	22.49	22.52	22.44
		5	0	22.44	22.48	22.34

Band/BW	Modulation	RB Size	RB Offset	Low CH 23025	Mid CH 23095	High CH 23165
				Frequency 700.5 MHz	Frequency 707.5 MHz	Frequency 714.5 MHz
12/ 3	QPSK	1	0	22.45	22.63	22.43
		1	5	22.42	22.66	22.42
		3	0	22.51	22.51	22.38
		3	3	22.44	22.41	22.28
		6	0	22.51	22.63	22.49
	16QAM	1	0	22.53	22.66	22.53
		1	5	22.60	22.57	22.52
		3	0	22.42	22.63	22.38
		3	3	22.49	22.53	22.49
		5	0	22.49	22.57	22.40



Band/BW	Modulation	RB Size	RB Offset	Low CH 23035	Mid CH 23095	High CH 23155
				Frequency 701.5 MHz	Frequency 707.5 MHz	Frequency 713.5 MHz
12/ 5	QPSK	1	0	22.46	22.63	22.43
		1	5	22.43	22.67	22.36
		3	0	22.42	22.47	22.34
		3	3	22.34	22.45	22.39
		6	0	22.55	22.71	22.59
	16QAM	1	0	22.48	22.61	22.56
		1	5	22.49	22.56	22.50
		3	0	22.43	22.55	22.43
		3	3	22.45	22.53	22.51
		5	0	22.38	22.53	22.45

Band/BW	Modulation	RB Size	RB Offset	Low CH 23060	Mid CH 23095	High CH 23130
				Frequency 704 MHz	Frequency 707.5 MHz	Frequency 711 MHz
12/ 10	QPSK	1	0	22.54	22.71	22.57
		1	5	22.52	22.69	22.46
		3	0	22.52	22.59	22.49
		3	3	22.45	22.51	22.41
		6	0	22.65	22.75	22.61
	16QAM	1	0	22.60	22.67	22.62
		1	5	22.62	22.60	22.55
		3	0	22.57	22.65	22.50
		3	3	22.51	22.62	22.56
		5	0	22.52	22.58	22.46



LTE Band 13

Band/BW	Modulation	RB Size	RB Offset	Low CH 23205	Mid CH 23230	High CH 23255
				Frequency 779.5 MHz	Frequency 782.0 MHz	Frequency 784.5 MHz
13/ 5	QPSK	1	0	23.12	23.14	23.09
		1	5	22.96	23.04	23.01
		3	0	23.03	22.94	22.94
		3	3	23.01	23.04	23.01
		6	0	23.01	23.02	23.08
	16QAM	1	0	23.06	23.13	23.17
		1	5	23.01	23.03	22.95
		3	0	23.13	23.03	23.00
		3	3	23.02	23.00	23.06
		5	0	23.03	23.03	23.04

Band/BW	Modulation	RB Size	RB Offset	/	Mid CH 23230	/
				/	Frequency 782.0 MHz	/
13/ 10	QPSK	1	0	/	23.15	/
		1	5	/	23.08	/
		3	0	/	23.09	/
		3	3	/	23.09	/
		6	0	/	23.10	/
	16QAM	1	0	/	23.19	/
		1	5	/	23.10	/
		3	0	/	23.15	/
		3	3	/	23.11	/
		5	0	/	23.15	/



ERP

LTE BAND 12

CHANNEL BANDWIDTH: 1.4MHz QPSK

Channel	Frequency (MHz)	Conducted Power (dBm)	G _T -L _c (dB)	ERP (dBm)	ERP (mW)	Limit (W)
23017	699.7	22.55	1.7	22.1	162.18	3
23095	707.5	22.68	1.7	22.23	167.11	3
23173	715.3	22.51	1.7	22.06	160.69	3

CHANNEL BANDWIDTH: 1.4MHz 16QAM

Channel	Frequency (MHz)	Conducted Power (dBm)	G _T -L _c (dB)	ERP (dBm)	ERP (mW)	Limit (W)
23017	699.7	22.53	1.7	22.08	161.44	3
23095	707.5	22.64	1.7	22.19	165.58	3
23173	715.3	22.53	1.7	22.08	161.44	3

CHANNEL BANDWIDTH: 3MHz QPSK

Channel	Frequency (MHz)	Conducted Power (dBm)	G _T -L _c (dB)	ERP (dBm)	ERP (mW)	Limit (W)
23025	700.5	22.51	1.7	22.06	160.69	3
23095	707.5	22.66	1.7	22.21	166.34	3
23165	714.5	22.49	1.7	22.04	159.96	3

CHANNEL BANDWIDTH: 3MHz 16QAM

Channel	Frequency (MHz)	Conducted Power (dBm)	G _T -L _c (dB)	ERP (dBm)	ERP (mW)	Limit (W)
23025	700.5	22.6	1.7	22.15	164.06	3
23095	707.5	22.66	1.7	22.21	166.34	3
23165	714.5	22.53	1.7	22.08	161.44	3



CHANNEL BANDWIDTH: 5MHz QPSK

Channel	Frequency (MHz)	Conducted Power (dBm)	G _T -L _c (dB)	ERP (dBm)	ERP (mW)	Limit (W)
23035	701.5	22.55	1.7	22.1	162.18	3
23095	707.5	22.71	1.7	22.26	168.27	3
23155	713.5	22.59	1.7	22.14	163.68	3

CHANNEL BANDWIDTH: 5MHz 16QAM

Channel	Frequency (MHz)	Conducted Power (dBm)	G _T -L _c (dB)	ERP (dBm)	ERP (mW)	Limit (W)
23035	701.5	22.49	1.7	22.04	159.96	3
23095	707.5	22.61	1.7	22.16	164.44	3
23155	713.5	22.56	1.7	22.11	162.55	3

CHANNEL BANDWIDTH: 10MHz QPSK

Channel	Frequency (MHz)	Conducted Power (dBm)	G _T -L _c (dB)	ERP (dBm)	ERP (mW)	Limit (W)
23060	704	22.65	1.7	22.2	165.96	3
23095	707.5	22.75	1.7	22.3	169.82	3
23130	711	22.61	1.7	22.16	164.44	3

CHANNEL BANDWIDTH: 10MHz 16QAM

Channel	Frequency (MHz)	Conducted Power (dBm)	G _T -L _c (dB)	ERP (dBm)	ERP (mW)	Limit (W)
23060	704	22.62	1.7	22.17	164.82	3
23095	707.5	22.67	1.7	22.22	166.72	3
23130	711	22.62	1.7	22.17	164.82	3

REMARKS: ERP Output Power (dBm) = EIRP (dBm) -2.15(dB).



LTE BAND 13

CHANNEL BANDWIDTH: 5MHz QPSK

Channel	Frequency (MHz)	Conducted Power (dBm)	G _T -L _c (dB)	ERP (dBm)	ERP (mW)	Limit (W)
23205	779.5	23.12	1.7	22.67	184.93	3
23230	782	23.14	1.7	22.69	185.78	3
23255	784.5	23.09	1.7	22.64	183.65	3

CHANNEL BANDWIDTH: 5MHz 16QAM

Channel	Frequency (MHz)	Conducted Power (dBm)	G _T -L _c (dB)	ERP (dBm)	ERP (mW)	Limit (W)
23205	779.5	23.13	1.7	22.68	185.35	3
23230	782	23.13	1.7	22.68	185.35	3
23255	784.5	23.17	1.7	22.72	187.07	3

CHANNEL BANDWIDTH: 10MHz QPSK

Channel	Frequency (MHz)	Conducted Power (dBm)	G _T -L _c (dB)	ERP (dBm)	ERP (mW)	Limit (W)
-	-	-	-	-	-	-
23230	782	23.15	1.7	22.7	186.21	3
-	-	-	-	-	-	-

CHANNEL BANDWIDTH: 10MHz 16QAM

Channel	Frequency (MHz)	Conducted Power (dBm)	G _T -L _c (dB)	ERP (dBm)	ERP (mW)	Limit (W)
-	-	-	-	-	-	-
23230	782	23.19	1.7	22.74	187.93	3
-	-	-	-	-	-	-

REMARKS: ERP Output Power (dBm) = EIRP (dBm) -2.15(dB).



3.2 FREQUENCY STABILITY MEASUREMENT

3.2.1 LIMITS OF FREQUENCY STABILITY MEASUREMENT

The frequency stability shall be sufficient to ensure that the fundamental emissions stay within the authorized bands of operation.

3.2.2 TEST PROCEDURE

- a. Device is placed at the oven room. The oven room could control the temperatures and humidity. Power warm up is at least 15 min and power applied should perform before recording frequency error.
- b. EUT is connected the external power supply to control the DC input power. The test voltage range is from minimum to maximum working voltage. Each step shall be record the frequency error rate.
- c. The temperature range step is 10 degrees in this test items. All temperature levels shall be hold the $\pm 0.5^{\circ}\text{C}$ during the measurement testing. The each temperature step shall be at least 0.5 hours, consider the EUT could be test under the stability condition.

NOTE: The frequency error was recorded frequency error from the communication simulator.

3.2.3 TEST SETUP

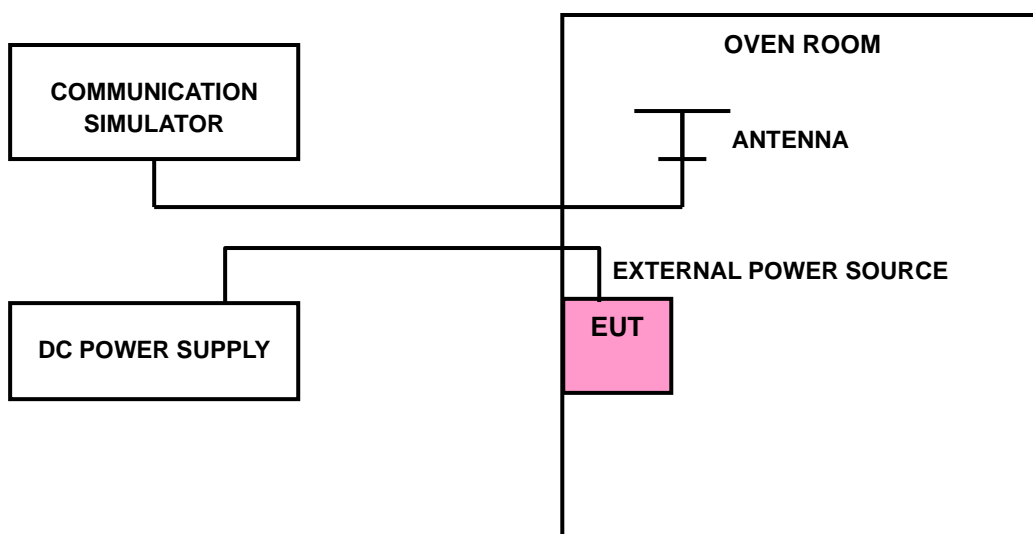



Test Report No.: W7L-P23100004R101

3.2.4 TEST RESULTS

Please Refer to Module report R1811A0536-R9.



3.3 OCCUPIED BANDWIDTH MEASUREMENT

3.3.1 LIMITS OF OCCUPIED BANDWIDTH MEASUREMENT

The width of a frequency band such that, below the lower and above the upper frequency limits, the mean powers emitted are each equal to a specified percentage 0.5 %of the total mean power of a given emission.

3.3.2 TEST SETUP

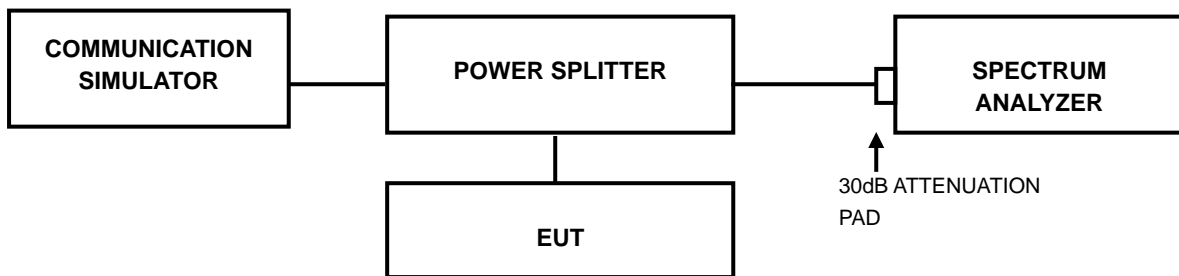

3.3.3 TEST PROCEDURES

- The conducted occupied bandwidth used the power splitter via EUT RF power connector between simulation base station and spectrum analyzer.
- Use OBW measurement function of Spectrum analyzer to measure 99 % occupied bandwidth.



**BUREAU
VERITAS**

Test Report No.: W7L-P23100004R101

3.3.4 TEST RESULTS

Please Refer to Module report R1811A0536-R9.



3.4 PEAK TO AVERAGE RATIO

3.4.1 LIMITS OF PEAK TO AVERAGE RATIO MEASUREMENT

In measuring transmissions in this band using an average power technique, the peak to-average ratio (PAR) of the transmission may not exceed 13 dB

3.4.2 TEST SETUP

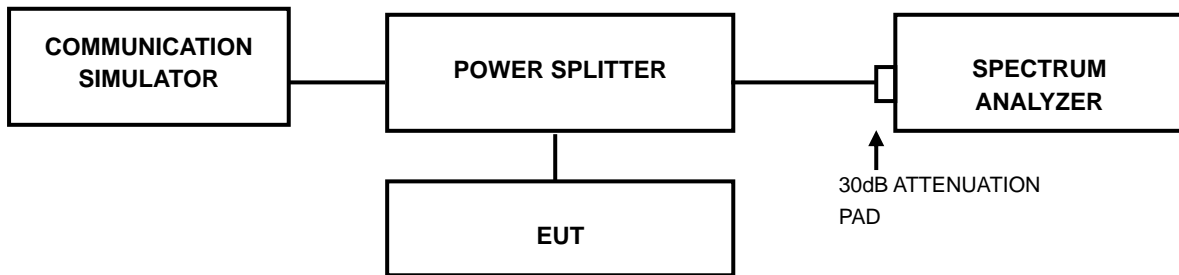

3.4.3 TEST PROCEDURES

1. Set resolution/measurement bandwidth \geq signal's occupied bandwidth;
2. Set the number of counts to a value that stabilizes the measured CCDF curve;
3. Record the maximum PAPR level associated with a probability of 0.1%.



3.4.4 TEST RESULTS

Please Refer to Module report R1811A0536-R9.



3.5 BAND EDGE MEASUREMENT

3.5.1 LIMITS OF BAND EDGE MEASUREMENT

The power of any emission outside a licensee's frequency band(s) of operation shall be attenuated below the transmitter power (P) within the licensed band(s) of operation, measured in watts, by at least $43 + 10 \log (P)$ dB. Compliance with this provision is based on the use of measurement instrumentation employing a resolution bandwidth of 100 kilohertz or greater.

However, in the 100 kilohertz bands immediately outside and adjacent to a licensee's frequency block, a resolution bandwidth of at least 30 kHz may be employed.

3.5.2 TEST SETUP

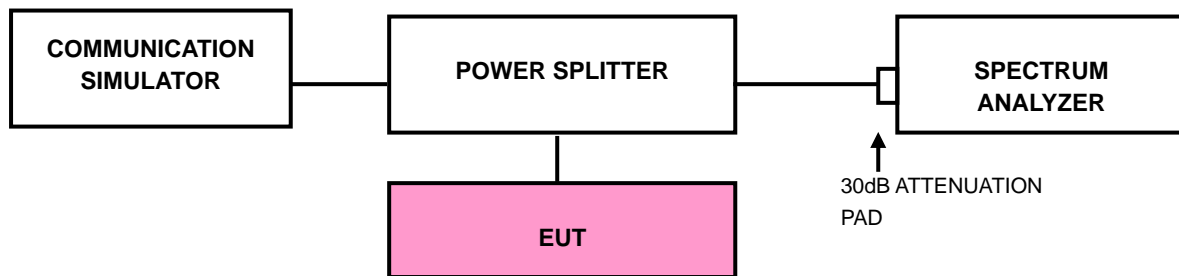



3.5.3 TEST PROCEDURES

- a) All measurements were done at low and high operational frequency range
- b) Connect the transmitter to the spectrum analyzer via coaxial cable while ensuring proper impedance matching.
- c) Tune the analyzer to the nominal center frequency of the emission bandwidth
(EBW)
- d) .Set the resolution bandwidth (RBW) $\geq 1\%$ EBW in the 1MHz band immediately outside and adjacent to the band edge.
- e) Beyond the 1MHz band from the band edge, RBW=1MHz was used.
- f) Set the video bandwidth (VBW) to $\geq 3 \times$ RBW.
- g) Select the average power (RMS) display detector.
- h) Set the number of measurement points to ≥ 1001 .
- i) Use auto-coupled sweep time.
- j) Perform the measurement over an interval of time when the transmission is continuous and at its maximum power level.
- k) The RF fundamental frequency should be excluded against the limit line in the operating frequency band and use RBW is 10KHz or 100KHz.
- l) Record the max trace plot into the test report.



Test Report No.: W7L-P23100004R101

3.5.4 TEST RESULTS

Please Refer to Module report R1811A0536-R9.



3.6 CONDUCTED SPURIOUS EMISSIONS

3.6.1 LIMITS OF CONDUCTED SPURIOUS EMISSIONS MEASUREMENT

The power of any emission outside a licensee's frequency block shall be attenuated below the transmitter power (P) by at least $43 + 10 \log_{10}(P)$ dB. The limit of emission equal to -13dBm

Additional unwanted emissions limits

In addition to the limit outlined in section 4.7.1 above, equipment operating in the frequency bands 746-756 MHz and 777-787 MHz shall also comply with the following restrictions:

- a. the power of any unwanted emissions in any 6.25 kHz bandwidth for all frequencies between 763-775 MHz and 793-806 MHz shall be attenuated below the transmitter power, P (dBW), by at least:
 - i. $76 + 10 \log_{10} p$ (watts), dB, for base and fixed equipment and
 - ii. $65 + 10 \log_{10} p$ (watts), dB, for mobile and portable equipment
- b. the e.i.r.p. in the band 1559-1610 MHz shall not exceed -70 dBW/MHz for wideband signal and -80 dBW for discrete emission with bandwidth less than 700 Hz.

3.6.2 TEST PROCEDURE

- a. The EUT makes a phone call to the communication simulator. All measurements were done at middle operational frequency range.
- b. Measuring frequency range is from 9 kHz up to a frequency including its 10th harmonic. 10dB attenuation pad is connected with spectrum. RBW=1MHz and VBW=3MHz are used for conducted emission measurement.



3.6.3 TEST SETUP

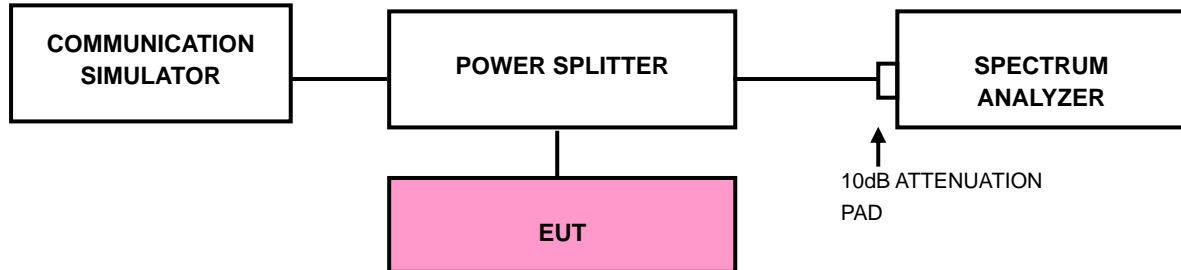



3.6.4 TEST RESULTS

NOTE : The 9K~30MHz amplitude of spurious emissions attenuated more than 20 dB below the permissible value is not required in the report.

Please Refer to Module report R1811A0536-R9.



3.7 RADIATED EMISSION MEASUREMENT

3.7.1 LIMITS OF RADIATED EMISSION MEASUREMENT

The power of any emission outside a licensee's frequency block shall be attenuated below the transmitter power (P) by at least $43 + 10 \log_{10}(P)$ dB. The limit of emission equal to -13dBm

The e.i.r.p. in the band 1559-1610 MHz shall not exceed -70 dBW/MHz for wideband signal and -80 dBW for discrete emission with bandwidth less than 700 Hz.

3.7.2 TEST PROCEDURES

- a. Substitution method is used for E.I.R.P measurement. In the semi-anechoic chamber, EUT placed on the 0.8m/1.5m height of Turn Table, rotated the table around 360 degrees to search the maximum radiation power and receiver antenna shall be rotated vertical and horizontal polarization and moved height from 1m to 4m to find the maximum polar radiated power. The "Read Value" is the spectrum reading the maximum power value.
- b. The substitution horn antenna is substituted for EUT at the same position and signals generator export the CW signal to the substitution antenna via a TX cable. Rotated the Turn Table and moved receiving antenna to find the maximum radiation power. Adjust output power level of S.G to get a Value of spectrum reading equal to "Read Value" of step a. Record the power level of S.G
- c. $\text{EIRP} = \text{Output power level of S.G} - \text{TX cable loss} + \text{Antenna gain of substitution horn.}$
- d. E.R.P power can be calculated form E.I.R.P power by subtracting the gain of dipole, $\text{E.R.P power} = \text{E.I.P.R power} - 2.15\text{dBi.}$

NOTE: The resolution bandwidth of spectrum analyzer is 1 MHz and the video bandwidth is 3 MHz.

3.7.3 DEVIATION FROM TEST STANDARD

No deviation



3.7.4 TEST SETUP

< Frequency Range below 30MHz >

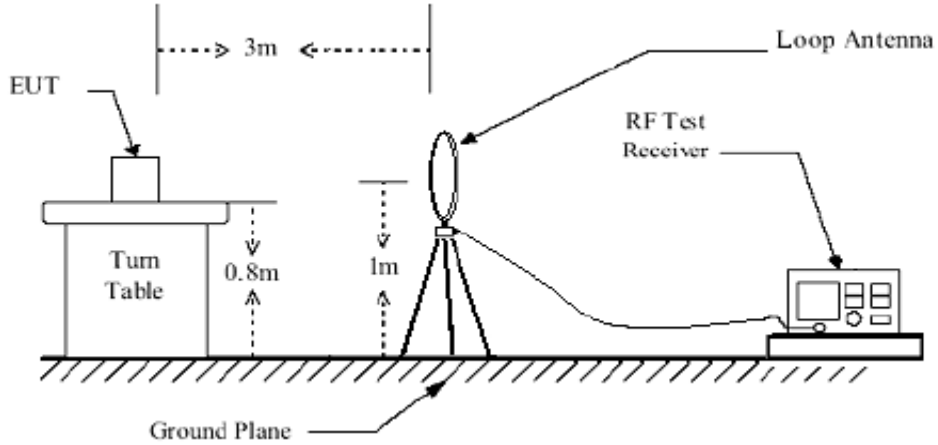

< Frequency Range 30MHz~1GHz >

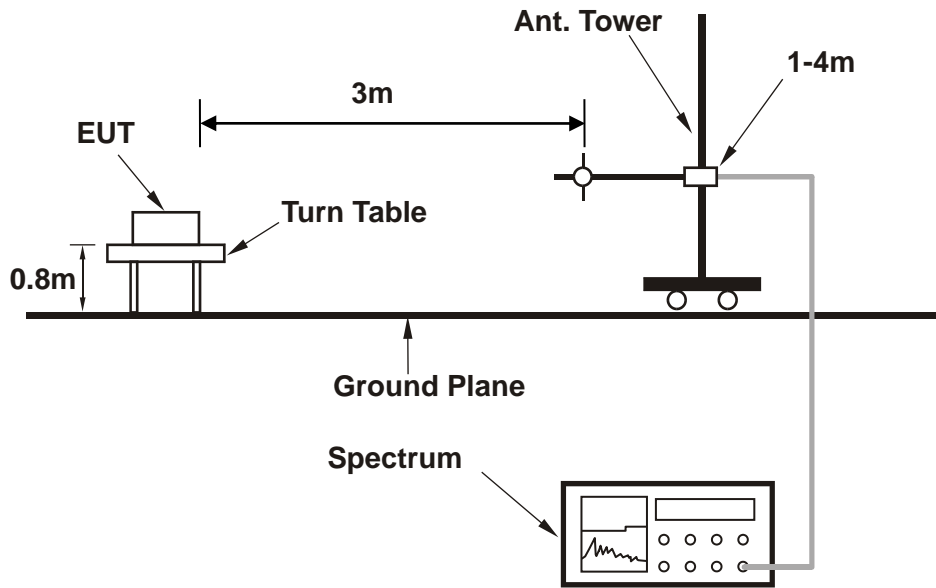



< Frequency Range above 1GHz >

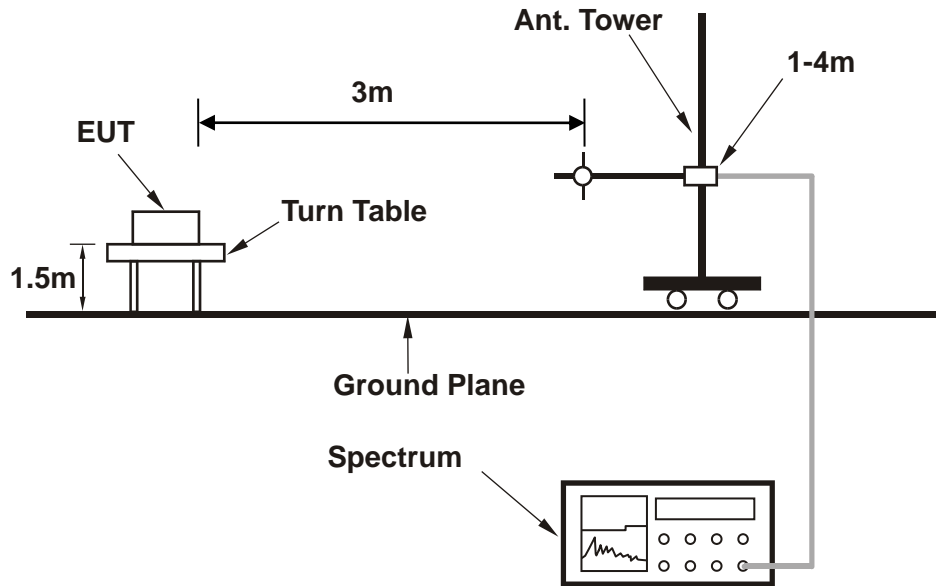

For the actual test configuration, please refer to the attached file (Test Setup Photo).



3.7.5 TEST RESULTS

NOTE : The 9K~30MHz amplitude of spurious emissions attenuated more than 20 dB below the permissible value is not required in the report.

BELOW 1GHz WORST-CASE DATA

30 MHz – 1GHz data:

LTE Band 13

CHANNEL BANDWIDTH: 5MHz / QPSK

MODE	TX channel 23230	FREQUENCY RANGE	Below 1000MHz
ENVIRONMENTAL CONDITIONS	23deg. C, 70%RH	INPUT POWER	AC 120V/60HZ
TESTED BY	Jace Hu		
ANTENNA POLARITY & TEST DISTANCE: HORIZONTAL AT 3 M			

No.	Frequency MHz	Factor dB	Reading dBm	Emission dBm	Limit dBm	Margin dB	Tower / Table cm deg	
* 1	33.11	-1.74	-54.06	-55.80	-13.00	-42.80	100	0
2	51.78	-12.58	-54.04	-66.62	-13.00	-53.62	100	0
3	145.03	-7.29	-57.28	-64.57	-13.00	-51.57	100	0
4	283.38	-7.01	-52.04	-59.05	-13.00	-46.05	100	0
5	364.21	-5.09	-62.86	-67.95	-13.00	-54.95	100	0
6	552.31	-0.60	-66.60	-67.20	-13.00	-54.20	100	0

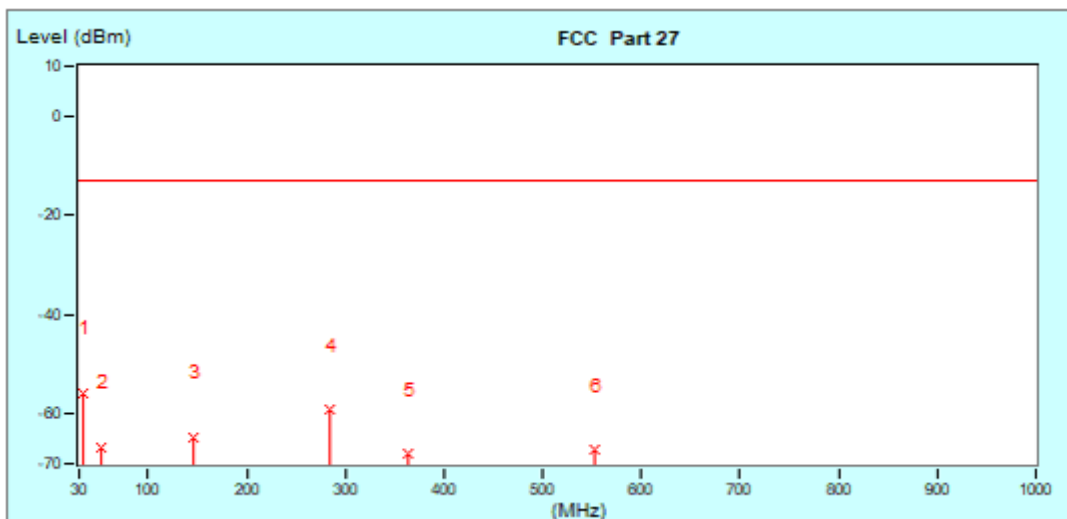



MODE	TX channel 23230	FREQUENCY RANGE	Below 1000MHz
ENVIRONMENTAL CONDITIONS	23deg. C, 70%RH	INPUT POWER	AC 120V/60HZ
TESTED BY	Jace Hu		
ANTENNA POLARITY & TEST DISTANCE: VERTICAL AT 3 M			

No.	Frequency MHz	Factor dB	Reading dBm	Emission dBm	Limit dBm	Margin dB	Tower / Table cm deg
* 1	42.44	-8.32	-34.54	-42.86	-13.00	-29.86	100 0
2	84.41	-12.71	-41.55	-54.26	-13.00	-41.26	100 0
3	117.05	-6.99	-45.06	-52.05	-13.00	-39.05	100 0
4	165.24	-8.25	-35.81	-44.06	-13.00	-31.06	100 0
5	205.66	-7.27	-52.21	-59.48	-13.00	-46.48	100 0
6	384.21	-5.09	-65.77	-70.86	-13.00	-57.86	100 0

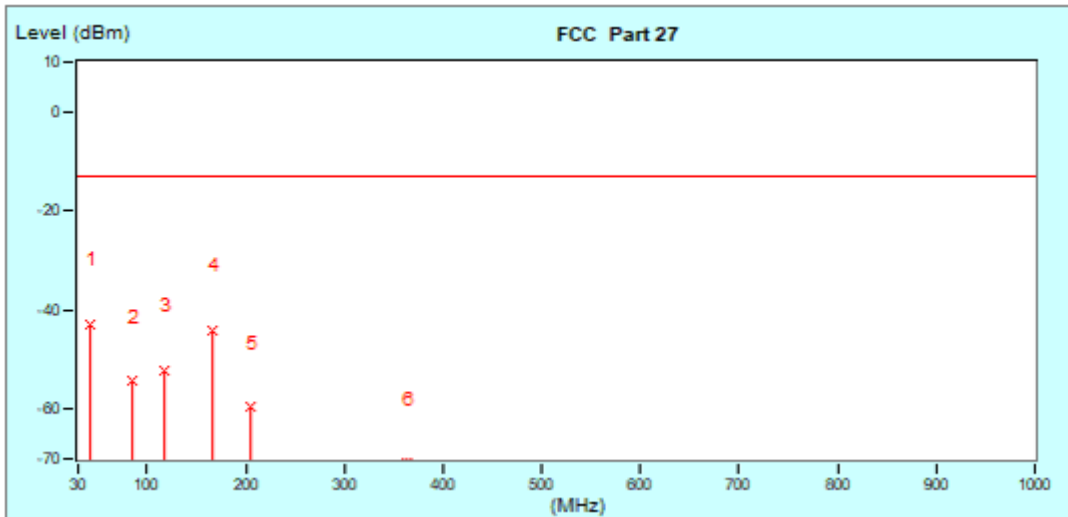



ABOVE 1GHz

Note: For higher frequency, the emission is too low to be detected.

LTE BAND 12

CHANNEL BANDWIDTH: 1.4MHz / QPSK

CH23017

MODE	TX channel 23017	FREQUENCY RANGE	Above 1000MHz
ENVIRONMENTAL CONDITIONS	23deg. C, 70%RH	INPUT POWER	AC 120V/60HZ
TESTED BY	Jace Hu		
ANTENNA POLARITY & TEST DISTANCE: HORIZONTAL AT 3 M			

No.	Frequency MHz	Factor dB	Reading dBm	Emission dBm	Limit dBm	Margin dB	Tower / Table cm deg
* 1	1399.40 (PK)	-15.03	-22.47	-37.50	-13.00	-24.50	100 0
2	2099.10 (PK)	-9.20	-40.60	-49.80	-13.00	-36.80	100 0

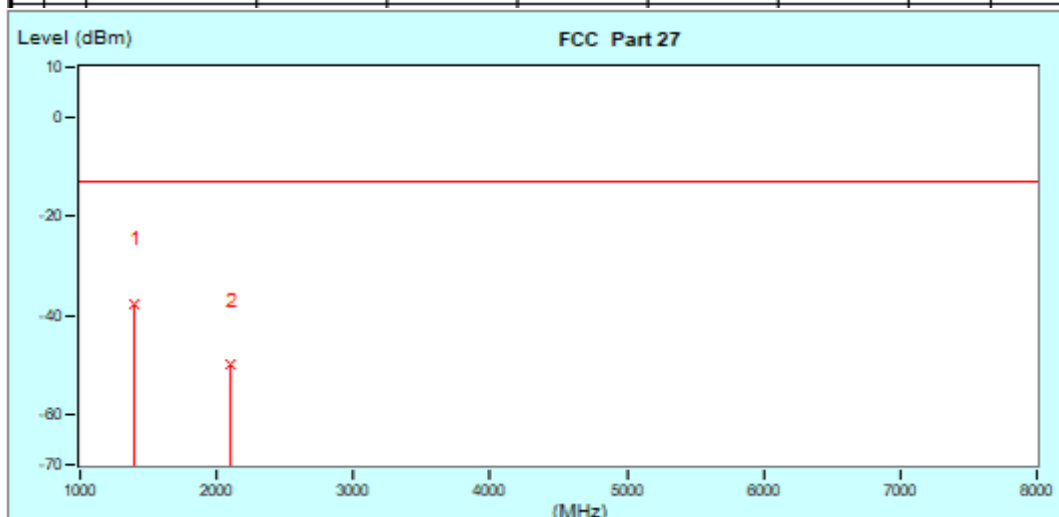



MODE	TX channel 23017	FREQUENCY RANGE	Above 1000MHz
ENVIRONMENTAL CONDITIONS	23deg. C, 70%RH	INPUT POWER	AC 120V/60HZ
TESTED BY	Jace Hu		
ANTENNA POLARITY & TEST DISTANCE: VERTICAL AT 3 M			

No.	Frequency MHz	Factor dB	Reading dBm	Emission dBm	Limit dBm	Margin dB	Tower / Table cm deg	
* 1	1399.40 (PK)	-15.03	-27.01	-42.04	-13.00	-29.04	100	0
2	2099.10 (PK)	-9.20	-37.92	-47.12	-13.00	-34.12	100	0

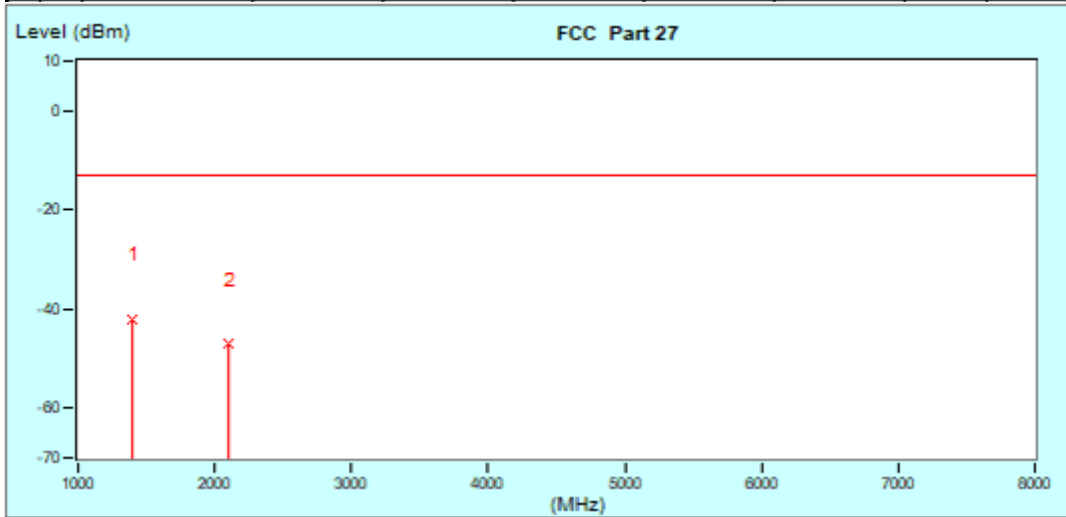



CH23095

MODE	TX channel 23095	FREQUENCY RANGE	Above 1000MHz
ENVIRONMENTAL CONDITIONS	23deg. C, 70%RH	INPUT POWER	AC 120V/60HZ
TESTED BY	Jace Hu		
ANTENNA POLARITY & TEST DISTANCE: HORIZONTAL AT 3 M			

No.	Frequency MHz	Factor dB	Reading dBm	Emission dBm	Limit dBm	Margin dB	Tower / Table cm deg
* 1	1415.00 (PK)	-15.01	-22.35	-37.36	-13.00	-24.36	100 0
2	2122.50 (PK)	-9.30	-37.24	-46.54	-13.00	-33.54	100 0

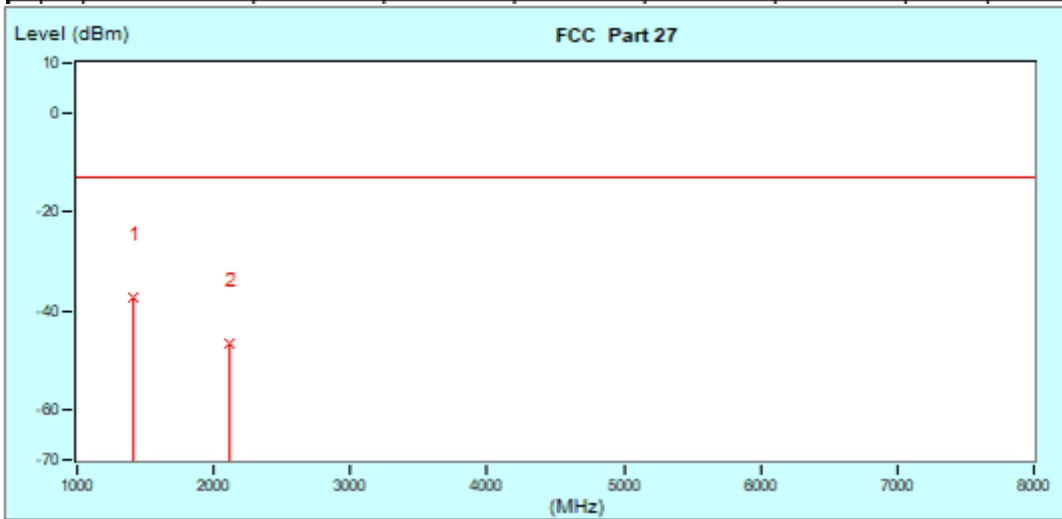



MODE	TX channel 23095	FREQUENCY RANGE	Above 1000MHz
ENVIRONMENTAL CONDITIONS	23deg. C, 70%RH	INPUT POWER	AC 120V/60HZ
TESTED BY	Jace Hu		
ANTENNA POLARITY & TEST DISTANCE: VERTICAL AT 3 M			

No.	Frequency MHz	Factor dB	Reading dBm	Emission dBm	Limit dBm	Margin dB	Tower / Table cm deg	
1	1415.00 (PK)	-15.01	-27.32	-42.33	-13.00	-29.33	100	0
2	2122.50 (PK)	-9.30	-38.63	-47.93	-13.00	-34.93	100	0

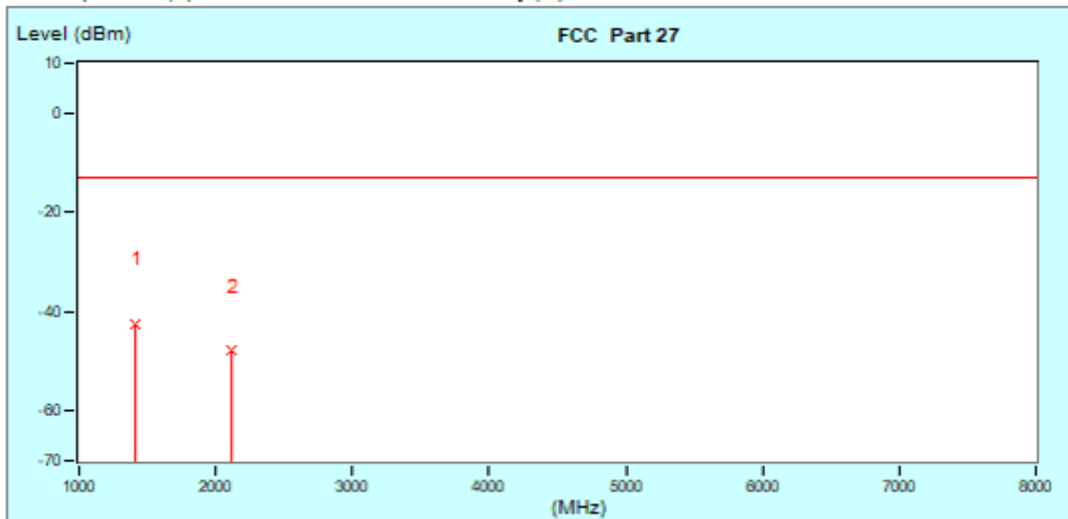



CH23173

MODE	TX channel 23173	FREQUENCY RANGE	Above 1000MHz
ENVIRONMENTAL CONDITIONS	23deg. C, 70%RH	INPUT POWER	AC 120V/60HZ
TESTED BY	Jace Hu		
ANTENNA POLARITY & TEST DISTANCE: HORIZONTAL AT 3 M			

No.	Frequency MHz	Factor dB	Reading dBm	Emission dBm	Limit dBm	Margin dB	Tower / Table cm deg	
1	1430.80 (PK)	-14.98	-20.74	-35.72	-13.00	-22.72	100	0
2	2145.90 (PK)	-9.41	-35.38	-44.79	-13.00	-31.79	100	0

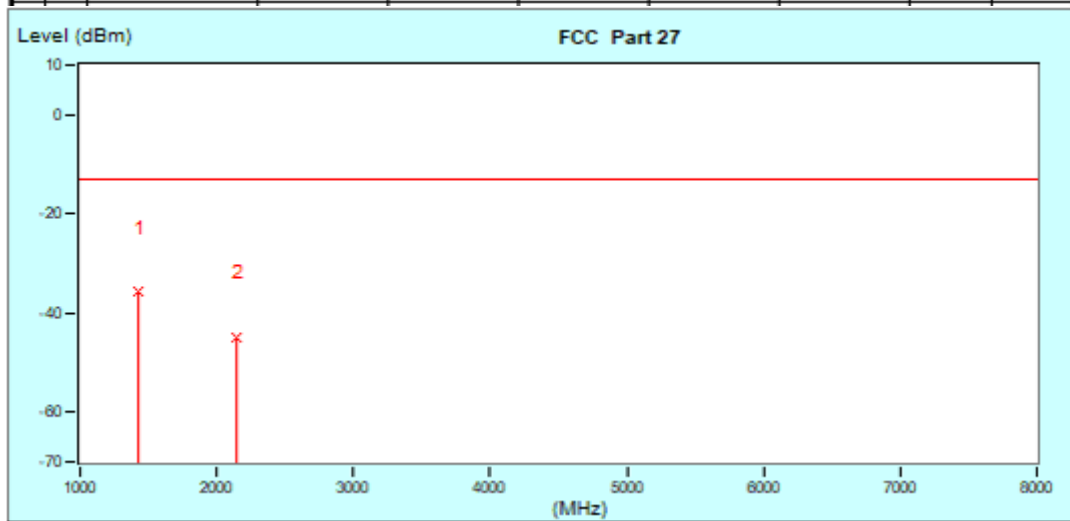



MODE	TX channel 23173	FREQUENCY RANGE	Above 1000MHz
ENVIRONMENTAL CONDITIONS	23deg. C, 70%RH	INPUT POWER	AC 120V/60HZ
TESTED BY	Jace Hu		
ANTENNA POLARITY & TEST DISTANCE: VERTICAL AT 3 M			

No.	Frequency MHz	Factor dB	Reading dBm	Emission dBm	Limit dBm	Margin dB	Tower / Table cm deg	
1	1430.80 (PK)	-14.98	-28.10	-43.08	-13.00	-30.08	100	0
2	2145.90 (PK)	-9.41	-40.31	-49.72	-13.00	-36.72	100	0

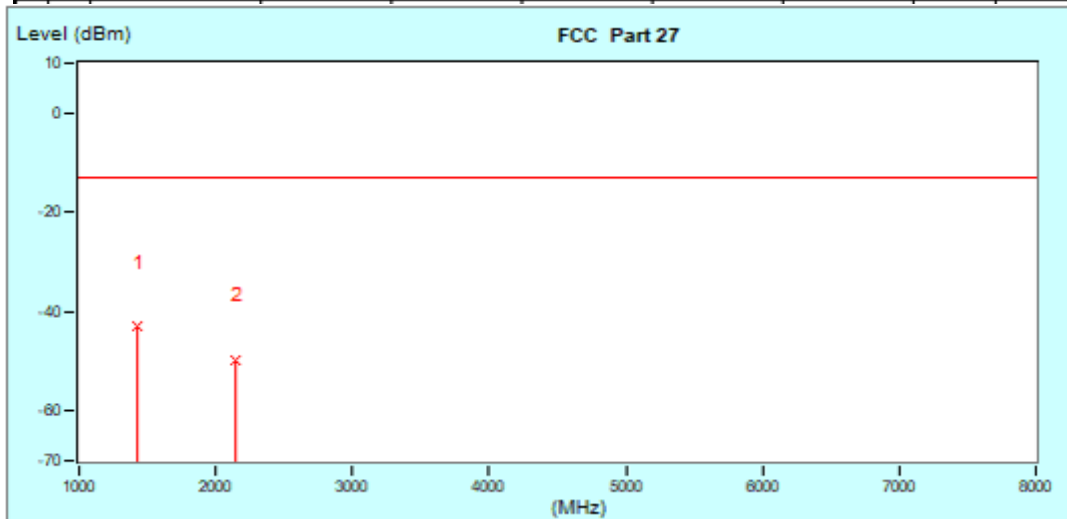



**BUREAU
VERITAS**

Test Report No.: W7L-P23100004R101

CHANNEL BANDWIDTH: 3MHz / QPSK

MODE	TX channel 23095	FREQUENCY RANGE	Above 1000MHz
ENVIRONMENTAL CONDITIONS	23deg. C, 70%RH	INPUT POWER	AC 120V/60HZ
TESTED BY	Jace Hu		
ANTENNA POLARITY & TEST DISTANCE: HORIZONTAL AT 3 M			

No.	Frequency MHz	Factor dB	Reading dBm	Emission dBm	Limit dBm	Margin dB	Tower / Table cm deg
* 1	1415.00 (PK)	-15.01	-23.18	-38.19	-13.00	-25.19	100 0
2	2122.50 (PK)	-9.30	-37.17	-48.47	-13.00	-33.47	100 0

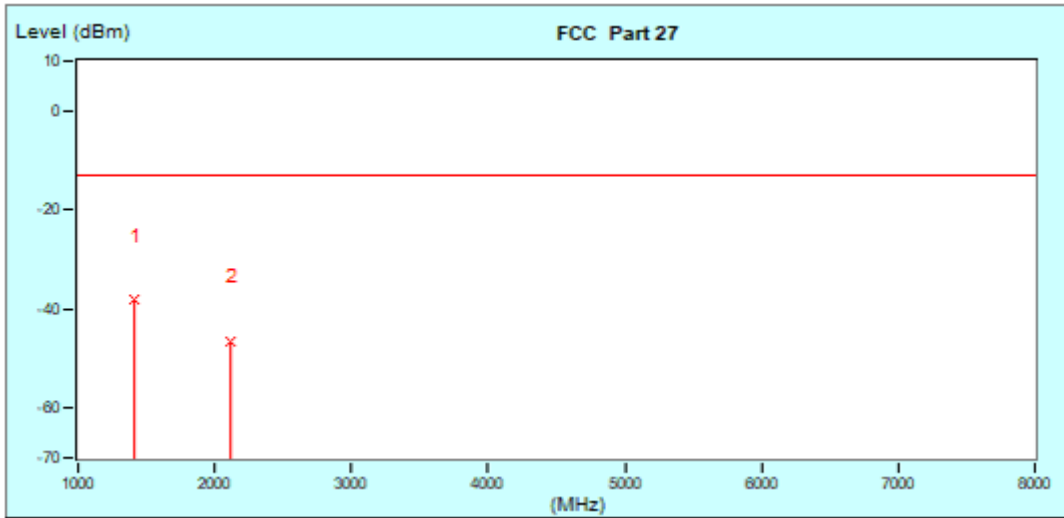



MODE	TX channel 23095	FREQUENCY RANGE	Above 1000MHz
ENVIRONMENTAL CONDITIONS	23deg. C, 70%RH	INPUT POWER	AC 120V/60HZ
TESTED BY	Jace Hu		
ANTENNA POLARITY & TEST DISTANCE: VERTICAL AT 3 M			

No.	Frequency MHz	Factor dB	Reading dBm	Emission dBm	Limit dBm	Margin dB	Tower / Table cm deg
* 1	1415.00 (PK)	-15.01	-27.35	-42.36	-13.00	-29.36	100 0
2	2122.50 (PK)	-9.30	-42.03	-51.33	-13.00	-38.33	100 0

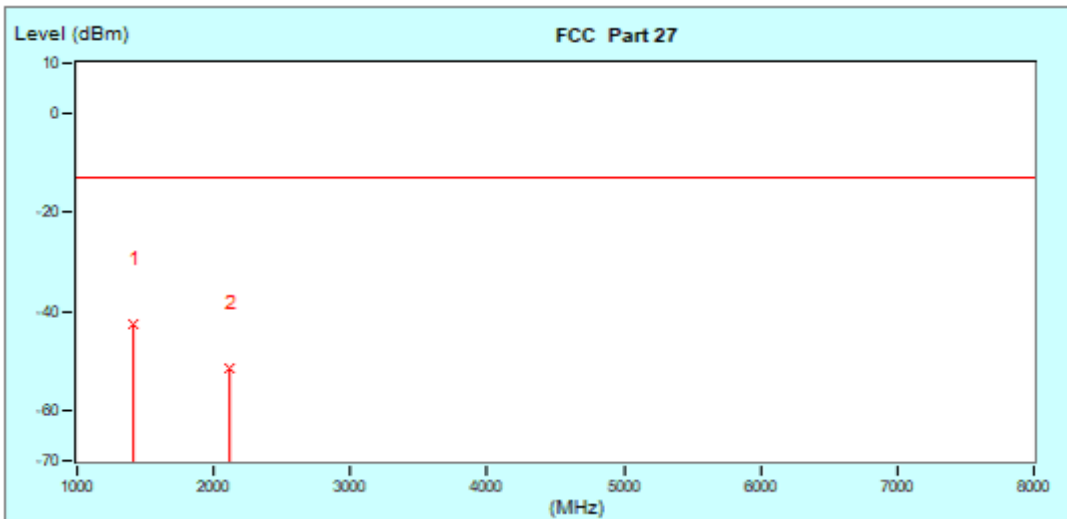



CHANNEL BANDWIDTH: 5MHz / QPSK

MODE	TX channel 23095	FREQUENCY RANGE	Above 1000MHz
ENVIRONMENTAL CONDITIONS	23deg. C, 70%RH	INPUT POWER	AC 120V/60HZ
TESTED BY	Jace Hu		
ANTENNA POLARITY & TEST DISTANCE: HORIZONTAL AT 3 M			

No.	Frequency MHz	Factor dB	Reading dBm	Emission dBm	Limit dBm	Margin dB	Tower / Table cm deg	
* 1	1415.00 (PK)	-15.01	-25.29	-40.30	-13.00	-27.30	100	0
2	2122.50 (PK)	-9.30	-46.75	-56.05	-13.00	-43.05	100	0

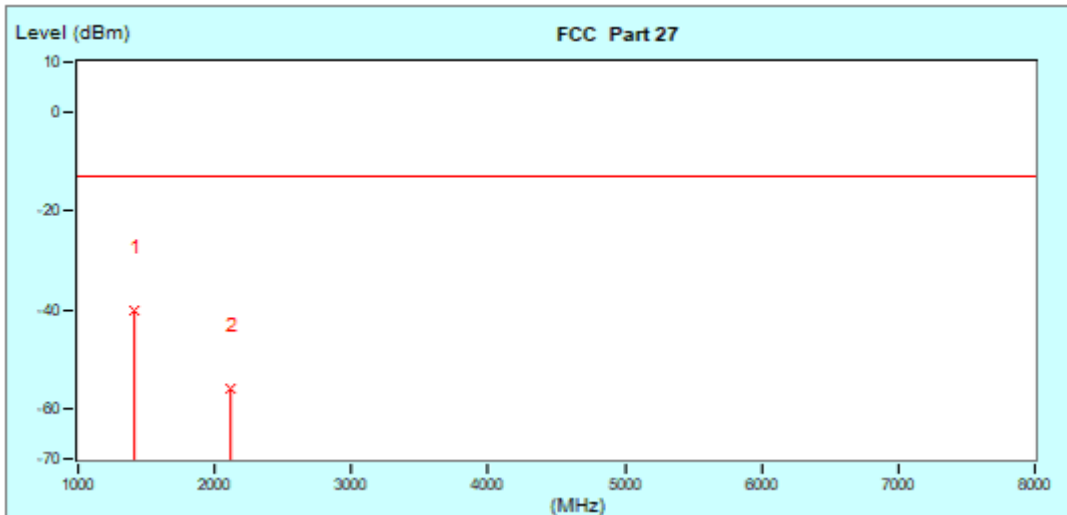



MODE	TX channel 23095	FREQUENCY RANGE	Above 1000MHz
ENVIRONMENTAL CONDITIONS	23deg. C, 70%RH	INPUT POWER	AC 120V/60HZ
TESTED BY	Jace Hu		
ANTENNA POLARITY & TEST DISTANCE: VERTICAL AT 3 M			

No.	Frequency MHz	Factor dB	Reading dBm	Emission dBm	Limit dBm	Margin dB	Tower / Table cm deg
* 1	1415.00 (PK)	-15.01	-27.00	-42.01	-13.00	-29.01	100 0
2	2122.50 (PK)	-9.30	-46.23	-55.53	-13.00	-42.53	100 0

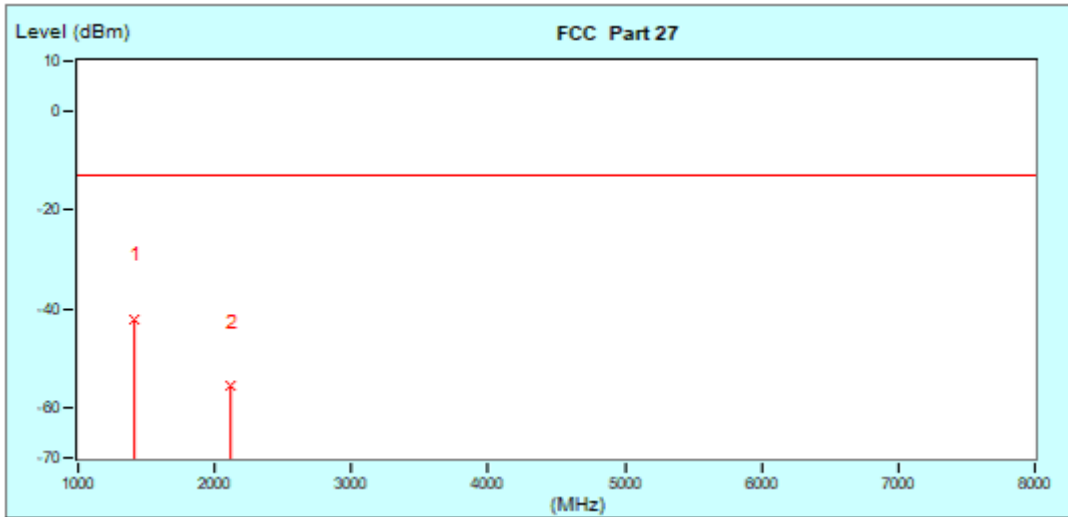



CHANNEL BANDWIDTH: 10MHz / QPSK

MODE	TX channel 23095	FREQUENCY RANGE	Above 1000MHz
ENVIRONMENTAL CONDITIONS	23deg. C, 70%RH	INPUT POWER	AC 120V/60HZ
TESTED BY	Jace Hu		
ANTENNA POLARITY & TEST DISTANCE: HORIZONTAL AT 3 M			

No.	Frequency MHz	Factor dB	Reading dBm	Emission dBm	Limit dBm	Margin dB	Tower / Table cm deg
1	1415.00 (PK)	-15.01	-48.08	-83.09	-13.00	-50.09	100 0
* 2	2122.50 (PK)	-9.30	-50.73	-80.03	-13.00	-47.03	100 0

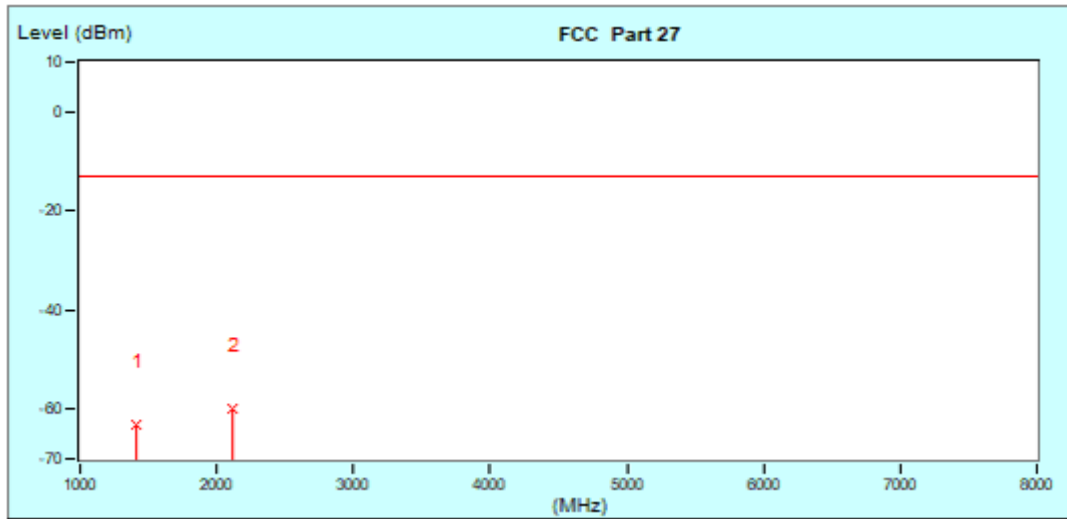



MODE	TX channel 23095	FREQUENCY RANGE	Above 1000MHz
ENVIRONMENTAL CONDITIONS	23deg. C, 70%RH	INPUT POWER	AC 120V/60HZ
TESTED BY	Jace Hu		
ANTENNA POLARITY & TEST DISTANCE: VERTICAL AT 3 M			

No.	Frequency MHz	Factor dB	Reading dBm	Emission dBm	Limit dBm	Margin dB	Tower / Table cm deg
1	1415.00 (PK)	5.72	-72.17	-66.45	-13.00	-53.45	100 0
* 2	2122.50 (PK)	5.72	-67.14	-61.42	-13.00	-48.42	100 0

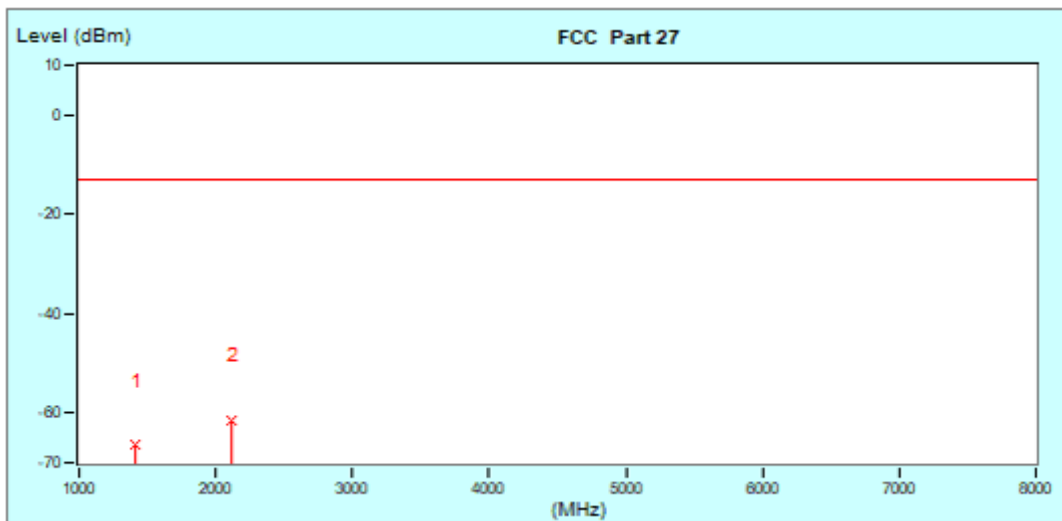



LTE B13

CHANNEL BANDWIDTH: 5MHz / QPSK

CH23205

MODE	TX channel 23205	FREQUENCY RANGE	Above 1000MHz
ENVIRONMENTAL CONDITIONS	23deg. C, 70%RH	INPUT POWER	AC 120V/60HZ
TESTED BY	Jace Hu		
ANTENNA POLARITY & TEST DISTANCE: HORIZONTAL AT 3 M			

No.	Frequency MHz	Factor dB	Reading dBm	Emission dBm	Limit dBm	Margin dB	Tower / Table cm deg
* 1	1559.00 (PK)	-14.15	-33.04	-47.19	-40.00	-7.19	100 0
2	2338.50 (PK)	-10.24	-47.79	-58.03	-13.00	-45.03	100 0

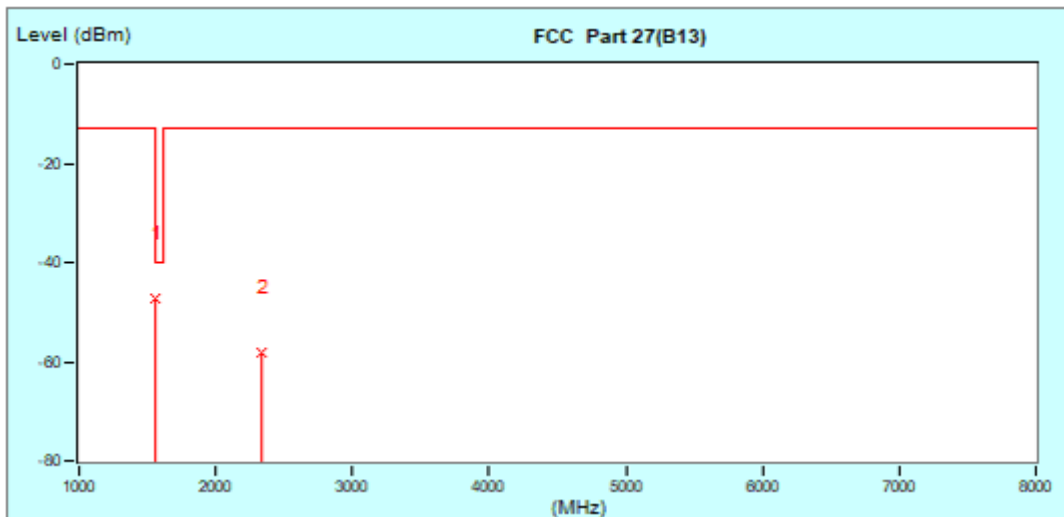



MODE	TX channel 23205	FREQUENCY RANGE	Above 1000MHz
ENVIRONMENTAL CONDITIONS	23deg. C, 70%RH	INPUT POWER	AC 120V/60HZ
TESTED BY	Jace Hu		
ANTENNA POLARITY & TEST DISTANCE: VERTICAL AT 3 M			

No.	Frequency MHz	Factor dB	Reading dBm	Emission dBm	Limit dBm	Margin dB	Tower / Table cm deg	
1	1559.00 (PK)	-14.15	-31.48	-45.63	-40.00	-5.63	100	0
2	2338.50 (PK)	-10.24	-50.21	-60.45	-13.00	-47.45	100	0

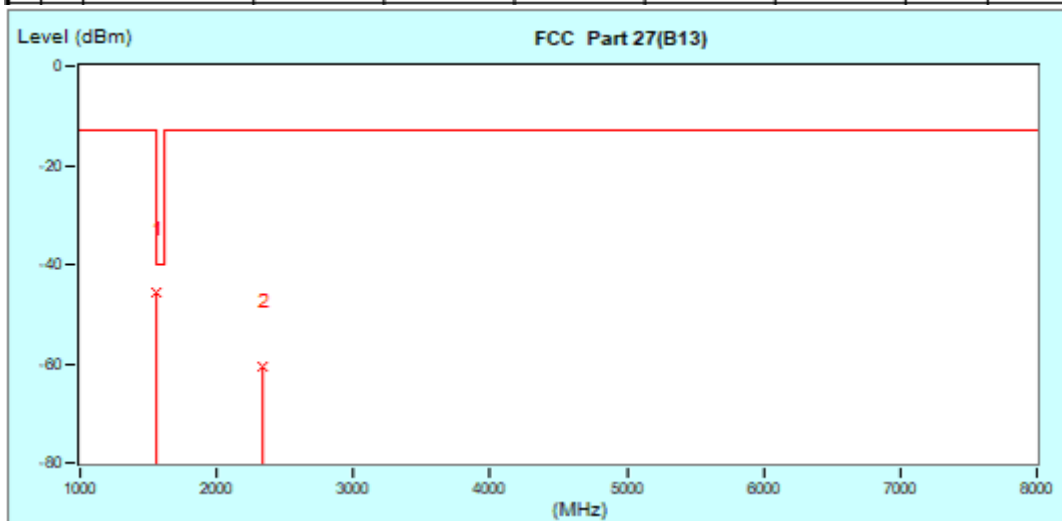



CH23230

MODE	TX channel 23230	FREQUENCY RANGE	Above 1000MHz
ENVIRONMENTAL CONDITIONS	23deg. C, 70%RH	INPUT POWER	AC 120V/60HZ
TESTED BY	Jace Hu		
ANTENNA POLARITY & TEST DISTANCE: HORIZONTAL AT 3 M			

No.	Frequency MHz	Factor dB	Reading dBm	Emission dBm	Limit dBm	Margin dB	Tower / Table cm deg
* 1	1564.00 (PK)	-14.09	-29.20	-43.29	-40.00	-3.29	100 0
2	2346.00 (PK)	-10.27	-45.63	-55.90	-13.00	-42.90	100 0

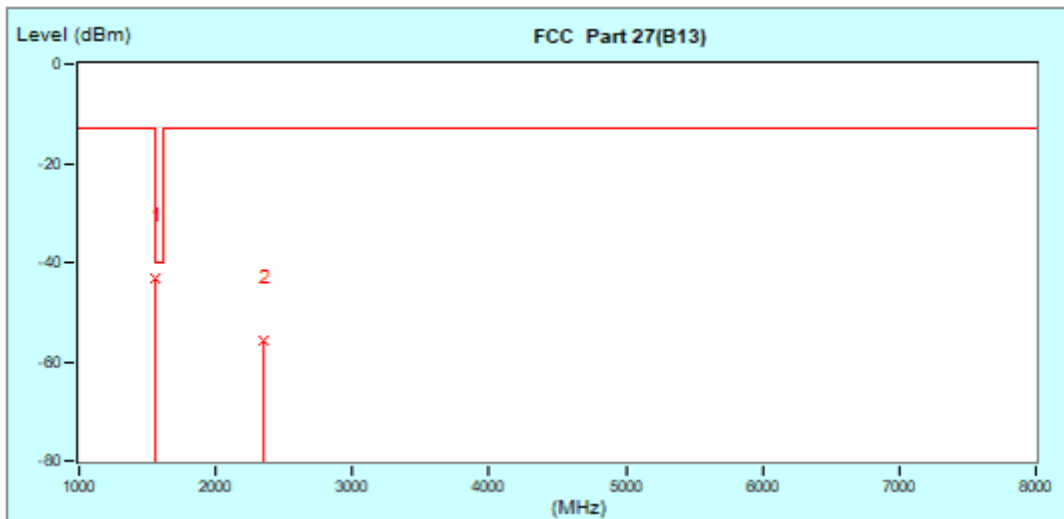



MODE	TX channel 23230	FREQUENCY RANGE	Above 1000MHz
ENVIRONMENTAL CONDITIONS	23deg. C, 70%RH	INPUT POWER	AC 120V/60HZ
TESTED BY	Jace Hu		
ANTENNA POLARITY & TEST DISTANCE: VERTICAL AT 3 M			

No.	Frequency MHz	Factor dB	Reading dBm	Emission dBm	Limit dBm	Margin dB	Tower / Table cm deg	
1	1564.00 (PK)	-14.09	-32.07	-46.16	-40.00	-6.16	100	0
2	2346.00 (PK)	-10.27	-41.99	-52.26	-13.00	-39.26	100	0

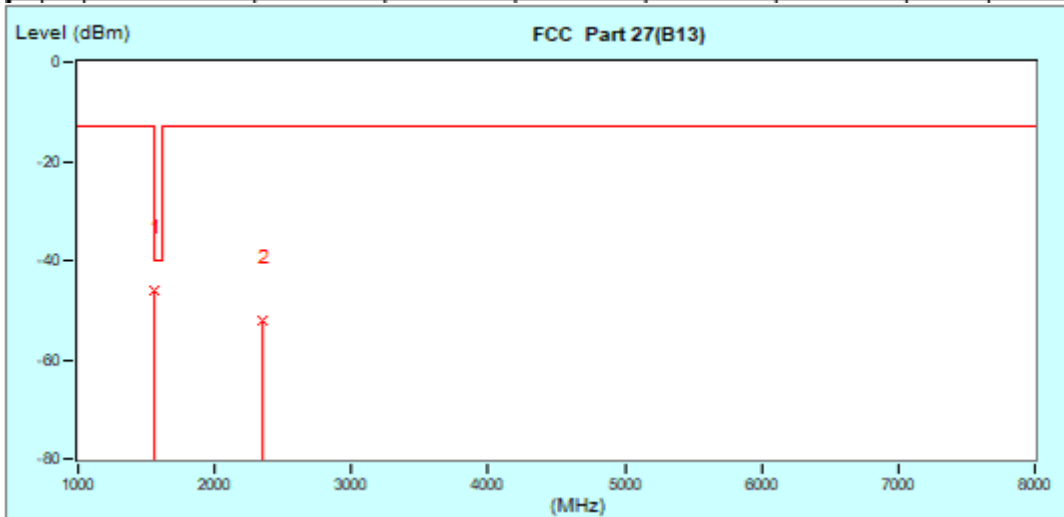



CH23255

MODE	TX channel 23255	FREQUENCY RANGE	Above 1000MHz
ENVIRONMENTAL CONDITIONS	23deg. C, 70%RH	INPUT POWER	AC 120V/60HZ
TESTED BY	Jace Hu		
ANTENNA POLARITY & TEST DISTANCE: HORIZONTAL AT 3 M			

No.	Frequency MHz	Factor dB	Reading dBm	Emission dBm	Limit dBm	Margin dB	Tower / Table cm deg
* 1	1589.00 (PK)	-14.03	-33.57	-47.60	-40.00	-7.60	100 0
2	2353.50 (PK)	-10.30	-41.95	-52.25	-13.00	-39.25	100 0

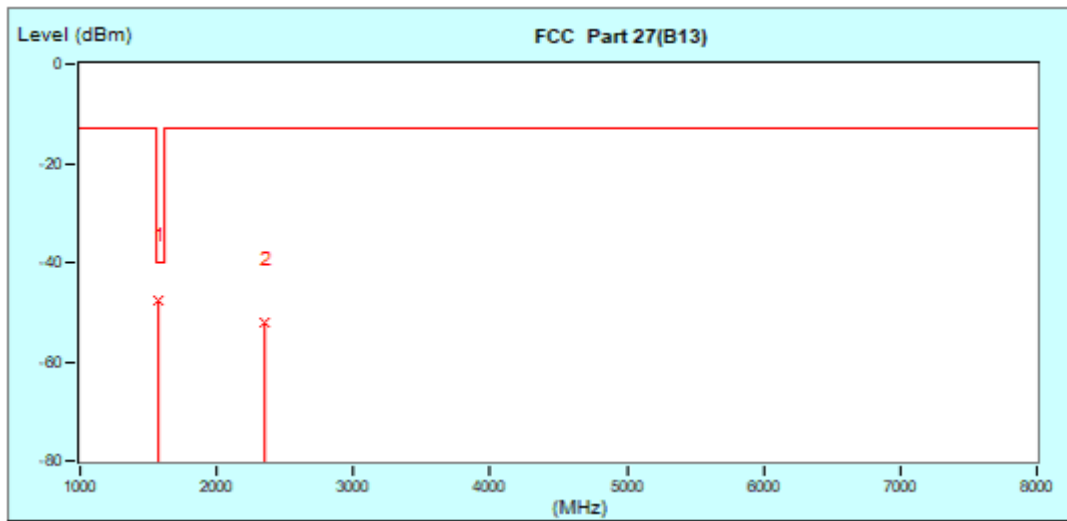



MODE	TX channel 23255	FREQUENCY RANGE	Above 1000MHz
ENVIRONMENTAL CONDITIONS	23deg. C, 70%RH	INPUT POWER	AC 120V/60HZ
TESTED BY	Jace Hu		
ANTENNA POLARITY & TEST DISTANCE: VERTICAL AT 3 M			

No.	Frequency MHz	Factor dB	Reading dBm	Emission dBm	Limit dBm	Margin dB	Tower / Table cm deg
* 1	1569.00 (PK)	-14.03	-33.82	-47.85	-40.00	-7.85	100 0
2	2353.50 (PK)	-10.30	-42.12	-52.42	-13.00	-39.42	100 0

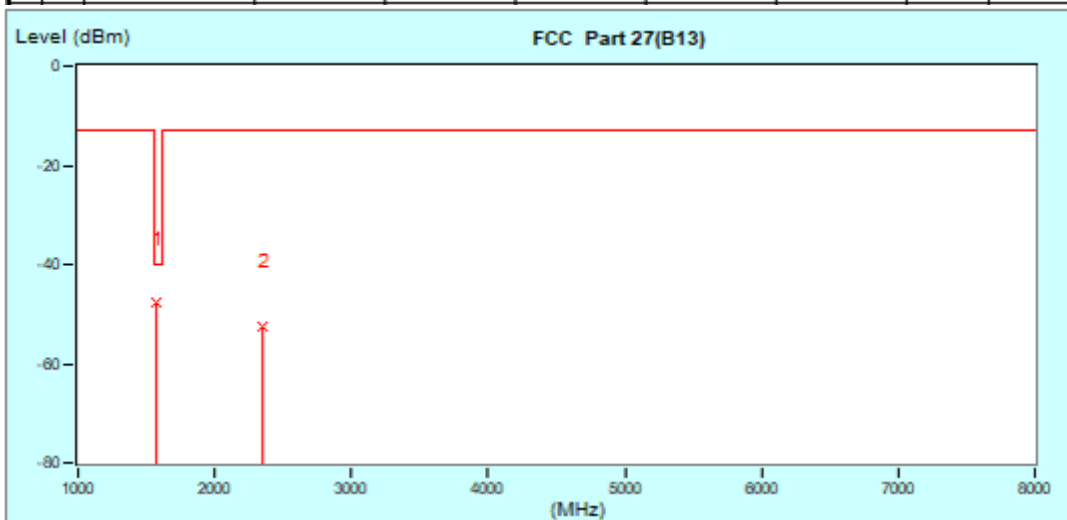



CHANNEL BANDWIDTH: 10MHz /QPSK

MODE	TX channel 23230	FREQUENCY RANGE	Above 1000MHz
ENVIRONMENTAL CONDITIONS	23deg. C, 70%RH	INPUT POWER	AC 120V/60HZ
TESTED BY	Jace Hu		
ANTENNA POLARITY & TEST DISTANCE: HORIZONTAL AT 3 M			

No.	Frequency MHz	Factor dB	Reading dBm	Emission dBm	Limit dBm	Margin dB	Tower / Table cm deg	
* 1	1564.00 (PK)	-14.09	-51.68	-65.77	-40.00	-25.77	100	0
2	2346.00 (PK)	-10.27	-52.10	-62.37	-13.00	-49.37	100	0

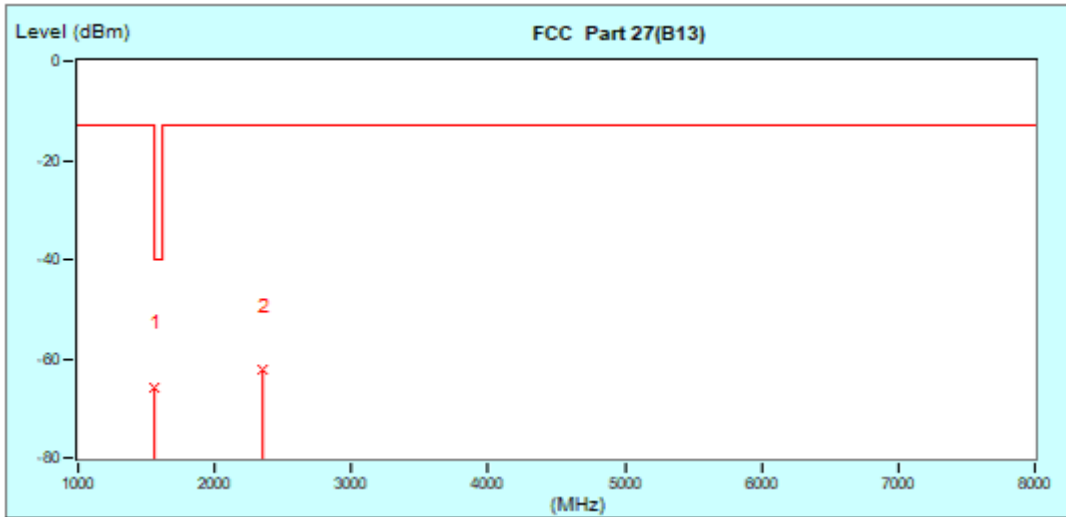



MODE	TX channel 23230	FREQUENCY RANGE	Above 1000MHz
ENVIRONMENTAL CONDITIONS	23deg. C, 70%RH	INPUT POWER	AC 120V/60HZ
TESTED BY	Jace Hu		
ANTENNA POLARITY & TEST DISTANCE: VERTICAL AT 3 M			

No.	Frequency MHz	Factor dB	Reading dBm	Emission dBm	Limit dBm	Margin dB	Tower / Table cm deg	
* 1	1584.00 (PK)	-14.09	-40.27	-54.36	-40.00	-14.36	100	0
2	2346.00 (PK)	-10.27	-52.06	-62.33	-13.00	-49.33	100	0

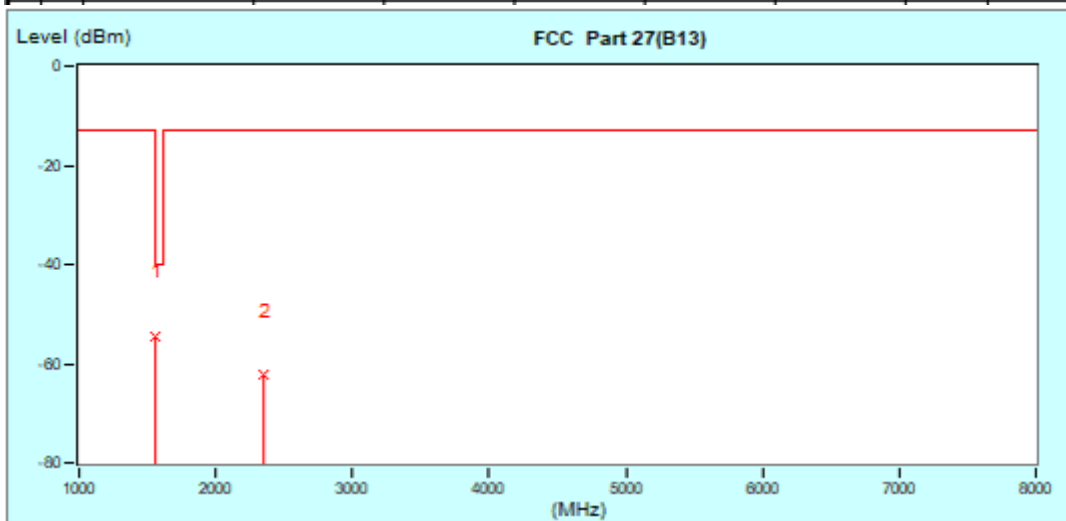



4 INFORMATION ON THE TESTING LABORATORIES

We, BV 7Layers Communications Technology (Shenzhen) Co. Ltd, were founded in 2015 to provide our best service in EMC, Radio, and Telecom. Our laboratories are accredited and approved according to ISO/IEC 17025.

If you have any comments, please feel free to contact us at the following:

Shenzhen EMC/RF Lab:

Tel: +86 755 8869 6566

Fax: +86 755 8869 6577

Email: customerservice.sw@bureauveritas.com

Web Site: www.adt.com.tw

The address and road map of all our labs can be found in our web site also.



5 MODIFICATIONS RECORDERS FOR ENGINEERING CHANGES TO THE EUT BY THE LAB

No modifications were made to the EUT by the lab during the test.

---END---