

TEST REPORT

Applicant	Particle Industries, Inc
Address	325 9th St, San Francisco, CA 94103 USA, 415-319-1553

Manufacturer or Supplier	Particle Industries, Inc	
Address	325 9th St, San Francisco, CA 94103 USA, 415-319-1553	
Product	M SoM	
Brand Name	Particle	
Model	M404	
Additional Model & Model Difference	N/A	
Date of tests	Jan. 11, 2024 ~ Feb. 23, 2024	

The submitted sample of the above equipment has been tested according to the requirements of the following standards:

EN 301 893 V2.1.1 (2017-05)

CONCLUSION: The submitted sample was found to COMPLY with the test requirement

Tested by Lucas Chen
Project Engineer / EMC Department

Approved by Glyn He
Assistant Manager / EMC Department



Date: Mar. 14, 2024

This report is governed by, and incorporates by reference, the Conditions of Testing as posted at the date of issuance of this report at <http://www.bureauveritas.com/home/about-us/our-business/cps/about-us/terms-conditions/> and is intended for your exclusive use. Any copying or replication of this report to or for any other person or entity, or use of our name or trademark, is permitted only with our prior written permission. This report sets forth our findings solely with respect to the test samples identified herein. The results set forth in this report are not indicative or representative of the quality or characteristics of the lot from which a test sample was taken or any similar or identical product unless specifically and expressly noted. Our report includes all of the tests requested by you and the results thereof based upon the information that you provided to us. Measurement uncertainty is only provided upon request for accredited tests. Statements of conformity are based on simple acceptance criteria without taking measurement uncertainty into account, unless otherwise requested in writing. You have 60 days from date of issuance of this report to notify us of any material error or omission caused by our negligence or if you require measurement uncertainty; provided, however, that such notice shall be in writing and shall specifically address the issue you wish to raise. A failure to raise such issue within the prescribed time shall constitute your unqualified acceptance of the completeness of this report, the tests conducted and the correctness of the report contents.



TABLE OF CONTENTS

RELEASE CONTROL RECORD 4

1 SUMMARY OF TEST RESULTS 5

1.1 TEST INSTRUMENTS 6

1.2 MEASUREMENT UNCERTAINTY 7

1.3 MAXIMUM MEASUREMENT UNCERTAINTY 8

2 GENERAL INFORMATION..... 9

2.1 GENERAL DESCRIPTION OF EUT 9

2.2 DESCRIPTION OF TEST MODES 10

2.2.1 TEST MODE APPLICABILITY AND TESTED CHANNEL DETAIL..... 11

2.3 GENERAL DESCRIPTION OF APPLIED STANDARDS..... 16

2.4 DESCRIPTION OF SUPPORT UNITS 16

3 TEST PROCEDURES AND RESULTS 17

3.1 CARRIER FREQUENCIES AND CHANNELIZATION 17

3.1.1 LIMITS OF CARRIER FREQUENCIES AND CHANNELIZATION 17

3.1.2 TEST PROCEDURES 17

3.1.3 TEST SETUP 17

3.1.4 TEST RESULTS 18

3.2 NOMINAL AND OCCUPIED CHANNEL BANDWIDTH MEASUREMENT 19

3.2.1 LIMITS OF NOMINAL AND OCCUPIED CHANNEL BANDWIDTH MEASUREMENT 19

3.2.2 TEST PROCEDURES 19

3.2.3 TEST SETUP 19

3.2.4 TEST RESULTS 20

3.3 RF OUTPUT POWER 21

3.3.1 LIMITS OF RF OUTPUT POWER AT THE HIGHEST POWER LEVEL..... 21

3.3.2 LIMITS OF RF OUTPUT POWER AT THE LOWEST POWER LEVEL 21

3.3.3 TEST PROCEDURES 22

3.3.4 TEST SETUP 22

3.3.5 TEST RESULTS FOR RF OUTPUT POWER AT THE HIGHEST POWER LEVEL 23

3.4 POWER DENSITY 24

3.4.1 LIMITS OF POWER DENSITY 24

3.4.2 TEST PROCEDURES 24

3.4.3 TEST SETUP 24

3.4.4 TEST RESULTS 25

3.5 ADAPTIVITY (CHANNEL ACCESS MECHANISM) 26

3.5.1 PRODUCT INFORMATION FOR ADAPTIVITY (CHANNEL ACCESS MECHANISM) 26

3.5.2 REQUIREMENTS AND LIMITS OF ADAPTIVE 27

3.5.3 TEST PROCEDURE..... 31

3.5.4 TEST SETUP CONFIGURATION..... 31

3.5.5 LIST OF MEASUREMENTS..... 32

3.5.6 INTERFERENCE THRESHOLD LEVEL 32

3.5.7 TEST RESULT 36

3.5.7.1 ADAPTIVITY TEST RESULT..... 36

3.5.7.2 OPERATING FREQUENCY BANDS AND MODE OF EUT 36

3.5.7.3 TEST RESULTS OF MEDIUM ACCESS MECHANISM 41

3.6 MEDIUM ACCESS PROTOCOL..... 43

3.6.1 DEFINITION..... 43

3.6.2 REQUIREMENT 43

3.7 USER ACCESS RESTRICTIONS..... 43



3.7.1	DEFINITION.....	43
3.7.2	REQUIREMENT	43
3.8	TRANSMITTER UNWANTED EMISSIONS OUTSIDE THE 5 GHZ RLAN BANDS.....	44
3.8.1	LIMITS OF UNWANTED CONDUCTED EMISSIONS OUTSIDE THE 5 GHZ RLAN BANDS 44	
3.8.2	TEST PROCEDURES	44
3.8.3	DEVIATION FROM TEST STANDARD	44
3.8.4	TEST SETUP	45
3.8.5	TEST RESULTS	46
3.9	TRANSMITTER UNWANTED EMISSIONS WITHIN THE 5GHZ RLAN BANDS.....	51
3.9.1	LIMITS OF UNWANTED EMISSIONS WITHIN THE 5GHZ RLAN BANDS	51
3.9.2	TEST PROCEDURES	51
3.9.3	DEVIATION FROM TEST STANDARD	51
3.9.4	TEST SETUP.....	52
3.9.5	TEST RESULTS	53
	RECEIVER PARAMETERS	56
3.10	RECEIVER SPURIOUS EMISSIONS.....	56
3.10.1	LIMIT OF RECEIVER SPURIOUS EMISSIONS	56
3.10.2	TEST PROCEDURES	56
3.10.3	DEVIATION FROM TEST STANDARD	56
3.10.4	TEST SETUP.....	56
3.10.5	TEST RESULTS	57
3.11	RECEIVER BLOCKING	60
3.11.1	LIMIT OF RECEIVER BLOCKING.....	60
3.11.2	TEST PROCEDURE.....	60
3.11.3	DEVIATION FROM TEST STANDARD	60
3.11.4	TEST SETUP CONFIGURATION.....	61
3.11.5	TEST RESULT	62
4	PHOTOGRAPHS OF THE TEST CONFIGURATION	63
5	APPENDIX A – MODIFICATIONS RECORDERS FOR ENGINEERING CHANGES TO THE EUT BY THE LAB	65



Test Report No.: RE2312WDG0147-4

RELEASE CONTROL RECORD

ISSUE NO.	REASON FOR CHANGE	DATE ISSUED
RE2312WDG0147-4	Original release	Mar. 14, 2024

1 SUMMARY OF TEST RESULTS

The EUT has been tested according to the following specifications:

EN 301 893 V2.1.1(2017-05)			
Clause	Test Parameter	Remarks	Pass/Fail
TRANSMITTER PARAMETERS			
4.2.1	Carrier Frequencies	Applicable	Pass
4.2.2	Occupied Channel Bandwidth	Applicable	Pass
4.2.3	RF Output Power	Applicable	Pass
4.2.3	Transmit Power Control (TPC)	Not Applicable	N/A
4.2.3	Power Density	Applicable	Pass
4.2.4.1	Transmitter unwanted emissions outside the 5GHz RLAN bands	Applicable	Pass
4.2.4.2	Transmitter unwanted emissions within the 5GHz RLAN bands	Applicable	Pass
4.2.6	Dynamic Frequency Selection	Applicable	Pass (Note)
4.2.7	Adaptivity (Channel Access Mechanism)	Applicable	Pass
4.2.9	User Access Restrictions	Applicable	Pass
4.2.10	Geo-location capability	Not Applicable	N/A
RECEIVER PARAMETERS			
4.2.5	Spurious Emissions	Applicable	Pass
4.2.8	Receiver Blocking	Applicable	Pass

Note: refer to DFS report (report No. RE2312WDG0147-5)

1.1 TEST INSTRUMENTS

Equipment	Manufacturer	Model No.	Serial No.	Next Cal.
EMI Test Receiver	Rohde&Schwarz	ESU40	100449	Jan. 02, 25
Signal and Spectrum Analyzer	Rohde&Schwarz	FSV40	101094	Jan. 01, 25
Trilog-Broadband Antenna	SCHWARZBECK	VULB 9168	9168-554	Jan. 08, 25
Horn Antenna	ETS-Lindgren	3117	00062558	Apr.01, 24
GPS Generator+ Antenna	TOJOIN	GNSS-5000A	E1-010119	N/A
3m Semi-anechoic Chamber	ETS-LINDGREN	9m*6m*6m	NSEMC003	May. 20, 24
Test Software	ADT	ADT_Radiated_V7.6.15.9.2	N/A	N/A
Test software	ADT	ADT_RF Test Software V6.6.5.3	N/A	N/A
Horn Antenna (15GHz-40GHz)	SCHWARZBECK	BBHA 9170	BBHA9170147	Apr. 01, 24
Amplifier	Burgeon	BPA-530	100220	Mar. 06, 24
Broadband Preamplifier (1GHz~18GHz)	SCHWARZBECK	BBV9718	305	Apr. 24, 24
Pre-Amplifier (18GHz-40GHz)	EMCI	EMC 184045	980102	Jan. 02 25
Power Sensor	Keysight	U2021XA	MY57320002	May. 11, 24
Humid & Temp Programmable Tester	Haida	HD-225T	1108072001	Oct. 15, 24
Oscilloscope	Agilent	DSO9254A	MY51260160	Jul. 11, 24
Signal and Spectrum Analyzer	Rohde&Schwarz	FSV7	102331	Apr 05, 24
Spectrum Analyzer	Keysight	N9020A	MY55400499	Jan. 01, 25
MXG-B RF Vector Signal Generator	Keysight	N5182B	MY56200288	Jul. 11, 24
Wireless Connectivity Tester	Rohde&Schwarz	CMW270	102426	Apr. 05, 24
Vector Signal Generator	Rohde&Schwarz	SMBV100A	257579	Oct. 15, 24
Attenuator	MINI	BW-S10W2+	S130129FGE2	N/A

NOTES:

1. The test was performed in 966 Chamber and RF Oven room.
2. The calibration interval of the above test instruments is 12 months; equipment is calibrated by calibration laboratory accredited to ISO/IEC 17025 by a mutually recognized Accreditation.
3. The horn antenna is used only for the measurement of emission frequency above 1GHz if tested.

For Receiver Blocking test and Adaptivity test:

Equipment	Manufacturer	Model No.	Serial No.	Next Cal.
Wireless Connectivity Tester	Rohde&Schwarz	CMW270	102426	Apr. 05, 24
Signal Analyzer	Rohde&Schwarz	FSV7	102331	Apr. 05, 24
Spectrum Analyzer	Keysight	N9020A	MY55400499	Jan. 01, 25
Signal Generator	Agilent	N5183A	MY50140980	Jul. 23, 24
MXG-B RF Vector Signal Generator	Keysight	N5182B	MY56200288	Jul. 11, 24
Power Sensor	Keysight	U2021XA	MY57320002	May. 11, 24
Vector Signal Generator	Rohde&Schwarz	SMBV100A	257579	Oct. 15, 24
Agile Signal Generator	Agilent	8645A	Agilent	N/A
Shield Box	TOJOIN	MS4345-C	SZA18A 3038	N/A
Attenuator	TOJOIN	CHB-8-90-1-B 50SMA	0803002	N/A
COM Power Splitter	TOJOIN	PS-TX-2B	020801	N/A
COM Power Splitter	TOJOIN	PS-TX-2B	020802	N/A
Test software	TonScend	JS1120-3-1	V2.6.88.0330	N/A

NOTES:

1. The test was performed in RF Oven room.
2. The calibration interval of the above test instruments is 12 months; equipment is calibrated by calibration laboratory accredited to ISO/IEC 17025 by a mutually recognized Accreditation.

1.2 MEASUREMENT UNCERTAINTY

Where relevant, the following measurement uncertainty levels have been estimated for tests performed on the EUT:

PARAMETER	UNCERTAINTY
Radio frequency	1.06x10 ⁻⁸
RF power conducted	±0.56 dB
RF power radiated	±3.154dB
Spurious emissions, conducted	±1.017dB
Spurious emissions, radiated	±4.84dB
Humidity	0.3%
Temperature	0.23°C
Time	±4 %

This uncertainty represents an expanded uncertainty expressed at approximately the 95% confidence level using a coverage factor of k=2.

1.3 MAXIMUM MEASUREMENT UNCERTAINTY

For the test methods, according to ETSI EN 301 893 standard, the measurement uncertainty figures shall be calculated in accordance with TR 100 028-1 [2] and TR 100 028-2 [3] and shall correspond to an expansion factor (coverage factor) k = 1.96 or k = 2 (which provide confidence levels of respectively 95 % and 95.45 % in the case where the distributions characterizing the actual measurement uncertainties are normal (Gaussian)).

Maximum measurement uncertainty

PARAMETER	UNCERTAINTY
Radio frequency	±10 ppm
RF power conducted	±1.5 dB
RF power radiated	±6 dB
Spurious Emissions, conducted	±3 dB
Spurious Emissions, radiated	±6 dB
Humidity	±5 %
Temperature	±2°C
Time	±10 %

2 GENERAL INFORMATION

2.1 GENERAL DESCRIPTION OF EUT

PRODUCT	M SoM		
MODEL NO.	M404		
ADDITIONAL MODELS	N/A		
NOMINAL VOLTAGE	VCC: 3.8V. 3V3:3.3V		
OPERATING VOLTAGE RANGE	Vnom=3.8V _{dc}	Vmin= 3.3V _{dc}	Vmax=4.3V _{dc}
OPERATING TEMPERATURE RANGE	-35 ~ + 75°C		
MODULATION TECHNOLOGY	OFDM		
MODULATION TYPE	256QAM, 64QAM, 16QAM, QPSK, BPSK for OFDM		
TRANSMISSION RATE	802.11a: 54.0/ 48.0/ 36.0/ 24.0/ 18.0/ 12.0/ 9.0/ 6.0Mbps 802.11n: up to 150.0Mbps 802.11ac : up to 200.0Mbps		
OPERATING FREQUENCY	5180MHz ~ 5240MHz, 5260MHz ~ 5320MHz, 5500MHz ~ 5700MHz		
EIRP (MAX.)	18.86dBm		
ANTENNA TYPE	PCB antenna with 6.8dBi gain		
TPC FUNCTION	No Support		
I/O PORTS	Refer to user's manual		
CABLE SUPPLIED	N/A		

NOTES:

1. For a more detailed features description, please refer to the manufacturer's specifications or the user's manual.
2. For the test results, the EUT had been tested with all conditions, but only the worst case was shown in test report.
3. Please refer to the EUT photo document (Reference No.: W7L-P23120015) for detailed product photo.
4. The EUT provides completed transmitters and receivers, the EUT uses only one antenna at any time.

MODULATION MODE	TX FUNCTION
802.11a	1TX/1RX
802.11n (HT20) 802.11ac (VHT20)	1TX/1RX
802.11n (HT40) 802.11ac (VHT40)	1TX/1RX

* The modulation and bandwidth are similar for 802.11n mode for HT20 / HT40 and 802.11ac mode for VHT20 / VHT40, therefore investigated worst case for final test were chosen 802.11n (HT20/HT40) and record in the report.

2.2 DESCRIPTION OF TEST MODES

WLAN 5.18 ~ 5.32GHz

8 channels are provided for 802.11a, 802.11n (HT20), 802.11ac (VHT20):

CHANNEL	FREQUENCY	CHANNEL	FREQUENCY
36	5180MHz	52	5260MHz
40	5200MHz	56	5280MHz
44	5220MHz	60	5300MHz
48	5240MHz	64	5320MHz

4 channels are provided for 802.11n (HT40), 802.11ac (VHT40):

CHANNEL	FREQUENCY	CHANNEL	FREQUENCY
38	5190MHz	54	5270MHz
46	5230MHz	62	5310MHz

WLAN 5.50 ~ 5.700GHz

11 channels are provided for 802.11a, 802.11n (HT20), 802.11ac (VHT20):

CHANNEL	FREQUENCY	CHANNEL	FREQUENCY
100	5500MHz	124	5620MHz
104	5520MHz	128	5640MHz
108	5540MHz	132	5660MHz
112	5560MHz	136	5680MHz
116	5580MHz	140	5700MHz
120	5600MHz		

5 channels are provided for 802.11n (HT40), 802.11ac (VHT40):

CHANNEL	FREQUENCY	CHANNEL	FREQUENCY
102	5510MHz	126	5630MHz
110	5550MHz	134	5670MHz
118	5590MHz		

2.2.1 TEST MODE APPLICABILITY AND TESTED CHANNEL DETAIL

Pre-Scan has been conducted to determine the worst-case mode from all possible combinations between available modulations, data rates, XYZ axis and antenna ports.

The worst case was found when positioned on X axis for radiated emission. Following test modes were selected for the final test, and the final worst case is marked in boldface and recorded in the report:

EUT CONFIGURE MODE	APPLICABLE TO									DESCRIPTION
	FS	OB	ROP	PD	AD	SSM	SE<1G	SE≥1G	RB	
A	√	√	√	√	√	√	√	√	√	Powered by DC 3.8V from SOM Mini SYS test board with wifi(5G) link

Where **FS**: Frequency Stability **OB**: Occupied channel bandwidth measurement
ROP: RF output power, Transmit Power Control (TPC) **PD**: Power Density
AD: Adaptivity (Channel Access Mechanism) **SSM**: Signal under Spectrum Mask
SE≥1G: Spurious Emissions above 1GHz **SE<1G**: Spurious Emissions below 1GHz
RB: Receiving Blocking

CARRIER FREQUENCIES AND CHANNELIZATION (FREQUENCY STABILITY):

- Pre-Scan has been conducted to determine the worst-case mode from all possible combinations between available modulations, data rates and antenna ports (if EUT with antenna diversity architecture).
- Following channel(s) was (were) selected for the final test as listed below.

MODE	AVAILABLE CHANNEL	TESTED CHANNEL	MODULATION TECHNOLOGY	MODULATION TYPE	DATA RATE (Mbps)
802.11a	36 to 64	36, 64	OFDM	BPSK	6.0
	100 to 140	100, 140	OFDM	BPSK	6.0

OCCUPIED CHANNEL BANDWIDTH MEASUREMENT:

- Pre-Scan has been conducted to determine the worst-case mode from all possible combinations between available modulations, data rates and antenna ports (if EUT with antenna diversity architecture).
- Following channel(s) was (were) selected for the final test as listed below.

MODE	AVAILABLE CHANNEL	TESTED CHANNEL	MODULATION TECHNOLOGY	MODULATION TYPE	DATA RATE (Mbps)
802.11a	36 to 64	36, 64	OFDM	BPSK	6.0
	100 to 140	100, 140	OFDM	BPSK	6.0
802.11n (HT20)	36 to 64	36, 64	OFDM	BPSK	6.5
	100 to 140	100, 140	OFDM	BPSK	6.5
802.11n (HT40)	38 to 62	38, 62	OFDM	BPSK	13.5
	102 to 134	102, 134	OFDM	BPSK	13.5

RF OUTPUT POWER:

- Pre-Scan has been conducted to determine the worst-case mode from all possible combinations between available modulations, data rates and antenna ports (if EUT with antenna diversity architecture).
- Following channel(s) was (were) selected for the final test as listed below.

MODE	AVAILABLE CHANNEL	TESTED CHANNEL	MODULATION TECHNOLOGY	MODULATION TYPE	DATA RATE (Mbps)
802.11a	36 to 64	36, 64	OFDM	BPSK	6.0
	100 to 140	100, 140	OFDM	BPSK	6.0
802.11n (HT20)	36 to 64	36, 64	OFDM	BPSK	6.5
	100 to 140	100, 140	OFDM	BPSK	6.5
802.11n (HT40)	38 to 62	38, 62	OFDM	BPSK	13.5
	102 to 134	102, 134	OFDM	BPSK	13.5

POWER DENSITY:

- Pre-Scan has been conducted to determine the worst-case mode from all possible combinations between available modulations, data rates and antenna ports (if EUT with antenna diversity architecture).
- Following channel(s) was (were) selected for the final test as listed below.

MODE	AVAILABLE CHANNEL	TESTED CHANNEL	MODULATION TECHNOLOGY	MODULATION TYPE	DATA RATE (Mbps)
802.11a	36 to 64	36, 64	OFDM	BPSK	6.0
	100 to 140	100, 140	OFDM	BPSK	6.0
802.11n (HT20)	36 to 64	36, 64	OFDM	BPSK	6.5
	100 to 140	100, 140	OFDM	BPSK	6.5
802.11n (HT40)	38 to 62	38, 62	OFDM	BPSK	13.5
	102 to 134	102, 134	OFDM	BPSK	13.5

ADAPTIVITY TEST:

- Pre-Scan has been conducted to determine the worst-case mode from all possible combinations between available modulations, data rates and antenna ports (if EUT with antenna diversity architecture).
- Following channel(s) was (were) selected for the final test as listed below.

MODE	AVAILABLE CHANNEL	TESTED CHANNEL	MODULATION TECHNOLOGY	MODULATION TYPE
802.11a	36 to 64 100 to 140	36	OFDM	BPSK

TRANSMITTER UNWANTED EMISSIONS WITHIN THE 5GHZ RLAN BANDS (SIGNAL UNDER SPECTRUM MASK):

- Pre-Scan has been conducted to determine the worst-case mode from all possible combinations between available modulations, data rates and antenna ports (if EUT with antenna diversity architecture).
- Following channel(s) was (were) selected for the final test as listed below.

MODE	AVAILABLE CHANNEL	TESTED CHANNEL	MODULATION TECHNOLOGY	MODULATION TYPE	DATA RATE (Mbps)
802.11a	36 to 64	36, 64	OFDM	BPSK	6.0
	100 to 140	100, 140	OFDM	BPSK	6.0
802.11n (HT20)	36 to 64	36, 64	OFDM	BPSK	6.5
	100 to 140	100, 140	OFDM	BPSK	6.5
802.11n (HT40)	38 to 62	38, 62	OFDM	BPSK	13.5
	102 to 134	102, 134	OFDM	BPSK	13.5

SPURIOUS EMISSIONS TEST (BELOW 1 GHz):

- Pre-Scan has been conducted to determine the worst-case mode from all possible combinations between available modulations, data rates and antenna ports (if EUT with antenna diversity architecture).
- Following channel(s) was (were) selected for the final test as listed below.

MODE	AVAILABLE CHANNEL	TESTED CHANNEL	MODULATION TECHNOLOGY	MODULATION TYPE	DATA RATE (Mbps)
802.11a	36 to 64 100 to 140	36	OFDM	BPSK	6.0

SPURIOUS EMISSIONS TEST (ABOVE 1 GHz):

- Pre-Scan has been conducted to determine the worst-case mode from all possible combinations between available modulations, data rates and antenna ports (if EUT with antenna diversity architecture).
- Following channel(s) was (were) selected for the final test as listed below.
- 802.11a was the worst-case mode.

MODE	AVAILABLE CHANNEL	TESTED CHANNEL	MODULATION TECHNOLOGY	MODULATION TYPE	DATA RATE (Mbps)
802.11a	36 to 64	36, 64	OFDM	BPSK	6.0
	100 to 140	100, 140	OFDM	BPSK	6.0
802.11n (HT20)	36 to 64	36, 64	OFDM	BPSK	6.5
	100 to 140	100, 140	OFDM	BPSK	6.5
802.11n (HT40)	38 to 62	38, 62	OFDM	BPSK	13.5
	102 to 134	102, 134	OFDM	BPSK	13.5

RECEIVER BLOCKING TEST:

- Pre-Scan has been conducted to determine the worst-case mode from all possible combinations between available modulations, data rates and antenna ports (if EUT with antenna diversity architecture).
- Following channel(s) was (were) selected for the final test as listed below.

MODE	AVAILABLE CHANNEL	TESTED CHANNEL	MODULATION TECHNOLOGY	MODULATION TYPE	DATA RATE (Mbps)
802.11a	36 to 64	36	OFDM	BPSK	6.0
802.11a	100 to 140	140	OFDM	BPSK	6.0



**BUREAU
VERITAS**

Test Report No.: RE2312WDG0147-4

TEST CONDITION:

APPLICABLE TO	ENVIRONMENTAL CONDITIONS	INPUT POWER	TESTED BY
FS	25deg. C, 60%RH	DC 3.8V from SOM Mini SYS test board	Vincent
OB	25deg. C, 60%RH	DC 3.8V from SOM Mini SYS test board	Vincent
ROP	25deg. C, 60%RH	DC 3.8V from SOM Mini SYS test board	Vincent
PD	25deg. C, 60%RH	DC 3.8V from SOM Mini SYS test board	Vincent
AD	25deg. C, 60%RH	DC 3.8V from SOM Mini SYS test board	Vincent
SSM	25deg. C, 60%RH	DC 3.8V from SOM Mini SYS test board	Vincent
SE<1G	27deg. C, 56%RH	DC 3.8V from SOM Mini SYS test board	Stalker
SE≥1G	27deg. C, 56%RH	DC 3.8V from SOM Mini SYS test board	Stalker
RB	25deg. C, 60%RH	DC 3.8V from SOM Mini SYS test board	Yoyo

2.3 GENERAL DESCRIPTION OF APPLIED STANDARDS

The EUT is a RF product, according to the specifications of the manufacturers. It must comply with the requirements of the following standards:

EN 301 893 V2.1.1 (2017-05)

All test items have been performed and recorded as per the above standards.

2.4 DESCRIPTION OF SUPPORT UNITS

The EUT has been tested as an independent unit together with other necessary accessories or support units. The following support units or accessories were used to form a representative test configuration during the tests.

NO.	PRODUCT	BRAND	MODEL NO.	SERIAL NO.	FCC ID
1	Notebook	DELL	Inspiron 13-7378	GMSJZD2	N/A
2	Wireless Router	TP-LINK	TL-WVR1200G	N/A	N/A
3	SOM Mini SYS test board	N/A	V0.8	N/A	N/A
4	DC Source	Keysight	E3642A	MY56146098	N/A

NO.	SIGNAL CABLE DESCRIPTION OF THE ABOVE SUPPORT UNITS
1	AC Line: Unshielded, Detachable 0.8m; DC Line: Unshielded, Non-detachable 1.8m
2	AC Line: Unshielded, Detachable 1.0m
3	USB Cable: Shielded, Detachable, 0.5m
4	AC Line: Unshielded, Detachable 1.0m



3 TEST PROCEDURES AND RESULTS

3.1 CARRIER FREQUENCIES AND CHANNELIZATION

3.1.1 LIMITS OF CARRIER FREQUENCIES AND CHANNELIZATION

The actual center frequency for any given channel declared by the manufacturer shall be maintained within the range $f_c \pm 20$ ppm.

3.1.2 TEST PROCEDURES

Reference to ETSI EN 301 893 V2.1.1 clause 5.4.2

3.1.3 TEST SETUP

The test setup has been constructed as the normal use condition. The EUT shall be connected to spectrum analyzer.

1. Set resolution bandwidth (RBW) = 100KHz
2. Set the video bandwidth (VBW) = 300KHz
3. Centre Frequency = The centre frequency of the channel under test, Detector = RMS.
4. Trace mode = max hold.
5. Sweep Point= 30000, Sweep time = 1s.

3.1.4 TEST RESULTS

802.11a

TEST CONDITION			CARRIER CENTRE FREQUENCIES f_c (MHz)			
			(CH36) 5180 MHz		(CH140) 5700 MHz	
			Reading	ppm	Reading	ppm
T_{nom} (°C)	+25	V_{nom} (V)	5180.0071	1.3707	5700.0094	1.6491
T_{min} (°C)	-35	V_{min} (V)	5180.0183	3.5328	5700.0150	2.6316
		V_{max} (V)	5180.0199	3.8417	5700.0248	4.3509
T_{max} (°C)	+75	V_{min} (V)	5180.0163	3.1467	5700.0177	3.1053
		V_{max} (V)	5180.0195	3.7645	5700.0232	4.0702

3.2 NOMINAL AND OCCUPIED CHANNEL BANDWIDTH MEASUREMENT

3.2.1 LIMITS OF NOMINAL AND OCCUPIED CHANNEL BANDWIDTH MEASUREMENT

The Nominal Channel Bandwidth for a single Operating Channel shall be 20 MHz. Alternatively, equipment may implement a lower Nominal Channel Bandwidth with a minimum of 5 MHz, providing they still comply with the Nominal Centre Frequencies defined in clause 4.2.1.

The Occupied Channel Bandwidth shall be between 80 % and 100 % of the Nominal Channel Bandwidth. In case of smart antenna systems (devices with multiple transmit chains) each of the transmit chains shall meet this requirement. The Occupied Channel Bandwidth might change with time/payload.

During a Channel Occupancy Time (COT), equipment may operate temporarily with an Occupied Channel Bandwidth of less than 80 % of its Nominal Channel Bandwidth with a minimum of 2 MHz.

3.2.2 TEST PROCEDURES

Reference to ETSI EN 301 893 V2.1.1 clause 5.4.3

3.2.3 TEST SETUP

The test setup has been constructed as the normal use condition. In case of conducted measurements the transmitter shall be connected to the measuring equipment via a suitable attenuator. Controlling software has been activated to set the EUT on specific status.

1. Set resolution bandwidth (RBW) = 100KHz
2. Set the video bandwidth (VBW) = 300KHz
3. Centre Frequency = The centre frequency of the channel under test, Detector = RMS.
4. Trace mode = max hold.
5. Sweep Point= 30000, Sweep time = 2s.
6. Span = 40 MHz (for 20 MHz channel), 80 MHz (for 40 MHz channel)

3.2.4 TEST RESULTS

802.11a

CHANNEL	CHANNEL FREQUENCY (MHz)	OCCUPIED BANDWIDTH (MHz)	LIMIT (MHz)
36	5180	16.40	16-20
64	5320	16.40	16-20
100	5500	16.40	16-20
140	5700	16.40	16-20

802.11n (HT20)

CHANNEL	CHANNEL FREQUENCY (MHz)	OCCUPIED BANDWIDTH (MHz)	LIMIT (MHz)
36	5180	17.60	16-20
64	5320	17.68	16-20
100	5500	17.60	16-20
140	5700	17.68	16-20

802.11n (HT40)

CHANNEL	CHANNEL FREQUENCY (MHz)	OCCUPIED BANDWIDTH (MHz)	LIMIT (MHz)
38	5190	36.00	32-40
62	5310	36.00	32-40
102	5510	36.00	32-40
134	5670	36.00	32-40

3.3 RF OUTPUT POWER

3.3.1 LIMITS OF RF OUTPUT POWER AT THE HIGHEST POWER LEVEL

Frequency Range (MHz)	Mean e.i.r.p. limit (dBm)	
	With TPC	Without TPC
5150 to 5350	23	20 / 23 (see note 1)
5470 to 5725	30 (see note 2)	27 (see note 2)

NOTE 1:

The applicable limit is 20 dBm, except for transmissions whose nominal bandwidth falls completely within the band 5 150 MHz to 5 250 MHz, in which case the applicable limit is 23 dBm.

NOTE 2:

Slave devices without a Radar Interference Detection function shall comply with the limits for the band 5 250 MHz to 5 350 MHz.

NOTE 3:

In case of multiple (adjacent or non-adjacent) channels within the same sub-band, the total RF output power of all channels in that sub-band shall not exceed the limits defined above table.
In case of multiple, non-adjacent channels operating in separate sub-bands, the total RF output power in each of the sub-bands shall not exceed the limits defined above table.

3.3.2 LIMITS OF RF OUTPUT POWER AT THE LOWEST POWER LEVEL

Frequency Range (MHz)	Limit
5250 to 5350	17 dBm
5470 to 5725	24 dBm

NOTE: Slave devices without a Radar Interference Detection function shall comply with the limits for the band 5 250 MHz to 5 350 MHz



Test Report No.: RE2312WDG0147-4

3.3.3 TEST PROCEDURES

Reference to ETSI EN 301 893 V2.1.1 clause 5.4.4

3.3.4 TEST SETUP

The test setup has been constructed as the normal and extreme test conditions. In case of conducted measurements the transmitter shall be connected to the measuring equipment via a suitable attenuator. The RF power as defined in EN 301 893 clause 4.4.1.1 shall be measured and recorded. Controlling software has been activated to set the EUT on specific status.

3.3.5 TEST RESULTS FOR RF OUTPUT POWER AT THE HIGHEST POWER LEVEL

802.11a

TEST CONDITION			EQUIVALENT ISOTROPIC RADIATED POWER (dBm)			
			(CH36) 5180 MHz	(CH64) 5320 MHz	(CH100) 5500 MHz	(CH140) 5700 MHz
T _{nom} (°C)	+25	V _{nom} (V)	18.33	18.12	18.08	18.00
T _{min} (°C)	-35	V _{min} (V)	18.75	18.23	18.52	18.24
		V _{max} (V)	18.77	18.24	18.50	18.19
T _{max} (°C)	+75	V _{min} (V)	18.09	17.77	17.88	17.86
		V _{max} (V)	18.09	17.75	17.91	17.89

802.11n (HT20)

TEST CONDITION			EQUIVALENT ISOTROPIC RADIATED POWER (dBm)			
			(CH36) 5180 MHz	(CH64) 5320 MHz	(CH100) 5500 MHz	(CH140) 5700 MHz
T _{nom} (°C)	+25	V _{nom} (V)	18.25	18.61	18.44	18.57
T _{min} (°C)	-35	V _{min} (V)	18.65	18.70	18.86	18.79
		V _{max} (V)	18.67	18.71	18.84	18.74
T _{max} (°C)	+75	V _{min} (V)	18.01	18.26	18.24	18.43
		V _{max} (V)	18.01	18.24	18.27	18.46

802.11n (HT40)

TEST CONDITION			EQUIVALENT ISOTROPIC RADIATED POWER (dBm)			
			(CH38) 5190 MHz	(CH62) 5310 MHz	(CH102) 5510 MHz	(CH134) 5670 MHz
T _{nom} (°C)	+25	V _{nom} (V)	18.24	17.92	18.21	18.34
T _{min} (°C)	-35	V _{min} (V)	18.66	18.03	18.65	18.58
		V _{max} (V)	18.68	18.04	18.63	18.53
T _{max} (°C)	+75	V _{min} (V)	18.01	17.58	18.02	18.21
		V _{max} (V)	18.01	17.56	18.05	18.24

3.4 POWER DENSITY

3.4.1 LIMITS OF POWER DENSITY

Frequency Band (MHz)	Mean e.i.r.p. density limit (dBm/MHz)	
	With TPC	Without TPC
5150 to 5350	10	7 / 10 (see note 1)
5470 to 5725	17 (see note 2)	14 (see note 2)

NOTE 1:

The applicable limit is 7 dBm/MHz, except for transmissions whose nominal bandwidth falls completely within the band 5 150 MHz to 5 250 MHz, in which case the applicable limit is 10 dBm/MHz.

NOTE 2:

Slave devices without a Radar Interference Detection function shall comply with the limits for the band 5 250 MHz to 5 350 MHz.

NOTE 3:

In case of multiple (adjacent or non-adjacent) channels within the same sub-band, the total RF output power of all channels in that sub-band shall not exceed the limits defined above table.

In case of multiple, non-adjacent channels operating in separate sub-bands, the total RF output power in each of the sub-bands shall not exceed the limits defined above table

3.4.2 TEST PROCEDURES

Reference to ETSI EN 301 893 V2.1.1 clause 5.4.4

3.4.3 TEST SETUP

The transmitter shall be connected to the measuring equipment via a suitable attenuator and the power density value shall be measured and recorded.

1. Set resolution bandwidth (RBW) = 1MHz
2. Set the video bandwidth (VBW) = 3MHz
3. Centre Frequency = The centre frequency of the channel under test, Detector = RMS.
4. Trace mode = max hold.
5. Sweep Point= 30000, Sweep time = 1min.
6. Span = 40 MHz (for 20 MHz channel), 80 MHz (for 40 MHz channel)



3.4.4 TEST RESULTS

802.11a

CHANNEL	CHANNEL FREQUENCY (MHz)	POWER DENSITY (dBm/1MHz) (E.I.R.P)	LIMIT (dBm/1MHz) (E.I.R.P)	PASS/FAIL
36	5180	6.63	10	PASS
64	5320	6.37	7	PASS
100	5500	6.52	7	PASS
140	5700	6.55	7	PASS

802.11n (HT20)

CHANNEL	CHANNEL FREQUENCY (MHz)	POWER DENSITY (dBm/1MHz) (E.I.R.P)	LIMIT (dBm/1MHz) (E.I.R.P)	PASS/FAIL
36	5180	4.52	10	PASS
64	5320	5.83	7	PASS
100	5500	5.94	7	PASS
140	5700	6.58	7	PASS

802.11n (HT40)

CHANNEL	CHANNEL FREQUENCY (MHz)	POWER DENSITY (dBm/1MHz) (E.I.R.P)	LIMIT (dBm/1MHz) (E.I.R.P)	PASS/FAIL
38	5190	2.08	10	PASS
62	5310	2.97	7	PASS
102	5510	3.02	7	PASS
134	5670	3.42	7	PASS

3.5 ADAPTIVITY (CHANNEL ACCESS MECHANISM)

3.5.1 PRODUCT INFORMATION FOR ADAPTIVITY (CHANNEL ACCESS MECHANISM)

This requirement applies to equipment, testing shall be performed using the highest nominal channel Bandwidth. The manufacturer shall state whether the UUT is capable of operating as a Frame Based Equipment or Load Based Equipment. See tables for the applicability of adaptive requirements and limit for each of the operational modes.

Adaptivity (Channel Access Mechanism)	
<input type="checkbox"/> Frame Based Equipment	<input type="checkbox"/> The Frame Based Equipment equipment operates as an Initiating Device
	<input type="checkbox"/> The Frame Based Equipment equipment operates as an Responding Device
	<input type="checkbox"/> The Frame Based Equipment equipment can operate as an Initiating Device and as a Responding Device
<input checked="" type="checkbox"/> Load Based Equipment	<input type="checkbox"/> The Load Based Equipment equipment operates as a Supervising Device
	<input checked="" type="checkbox"/> The Load Based Equipment equipment operates as a Supervised Device
	<input type="checkbox"/> The Load Based Equipment equipment can operate as a Supervising and as a Supervised Device

Priority Classes implemented by the Load Based Equipment	
<input type="checkbox"/> Operating as a Supervising Device	<input type="checkbox"/> Priority Class 4 (Highest priority)
	<input type="checkbox"/> Priority Class 3
	<input type="checkbox"/> Priority Class 2 <input type="checkbox"/> Note 1 <input type="checkbox"/> Note 2
	<input type="checkbox"/> Priority Class 1 (Lowest priority) <input type="checkbox"/> Note 1
<input checked="" type="checkbox"/> Operating as a Supervised Device	<input type="checkbox"/> Priority Class 4 (Highest priority)
	<input type="checkbox"/> Priority Class 3
	<input checked="" type="checkbox"/> Priority Class 2 <input type="checkbox"/> Note 1 <input type="checkbox"/> Note 2
	<input type="checkbox"/> Priority Class 1 (Lowest priority) <input type="checkbox"/> Note 1

Energy Detection Threshold Level(TL)	
<input type="checkbox"/> Frame Based Equipment	For $P_H \leq 13$ dBm : TL = -75 dBm/MHz For 13 dBm < $P_H < 23$ dBm : TL = -85 dBm/MHz + (23 dBm - P_H) For $P_H \geq 23$ dBm : TL = -85 dBm/MHz (assumes a 0 dBi receive antenna and P_H to be specified in dBm e.i.r.p)
<input checked="" type="checkbox"/> Load Based Equipment	<input checked="" type="checkbox"/> Option 1: TL = -75 dBm/MHz (assumes a 0 dBi receive antenna)
	<input type="checkbox"/> Option 2: For $P_H \leq 13$ dBm : TL = -75 dBm/MHz For 13 dBm < $P_H < 23$ dBm : TL = -85 dBm/MHz + (23 dBm - P_H) For $P_H \geq 23$ dBm : TL = -85 dBm/MHz (assumes a 0 dBi receive antenna and P_H to be specified in dBm e.i.r.p)

3.5.2 REQUIREMENTS AND LIMITS OF ADAPTIVE

Channel Access Mechanism		
Requirement	Frame Based Equipment	Load Based Equipment
Minimum Clear Channel Assessment (CCA) Time	9 μ s	9 μ s
Maximum Channel Occupancy (COT) Time	95 % of the Fixed Frame Period (Note 1)	2 ~ 10 ms(see table 1 & 2)
Minimum Idle Period	5% COT, with a min of 100 μ s	25 μ s
Extended CCA check	NA	NA
Short Control Signalling Transmissions	Maximum duty cycle of 5 % within an observation period of 50 ms (see note 5)	

Note 1: The Fixed Frame Periods supported by the equipment shall be declared by the manufacturer and shall be within the range of 1 ms to 10 ms.

Table 1: Priority Class dependent Channel Access parameters for Supervising Devices

Class #	p_0	CW_{min}	CW_{max}	maximum Channel Occupancy Time (COT)
4	1	3	7	2 ms
3	1	7	15	4 ms
2	3	15	63	6 ms (see note 1 and note 2)
1	7	15	1 023	6 ms (see note 1)

NOTE 1: The maximum *Channel Occupancy Time* (COT) of 6 ms may be increased to 8 ms by inserting one or more pauses. The minimum duration of a pause shall be 100 μ s. The maximum duration (Channel Occupancy) before including any such pause shall be 6 ms. Pause duration is not included in the channel occupancy time.

NOTE 2: The maximum Channel Occupancy Time (COT) of 6 ms may be increased to 10 ms by extending CW to $CW \times 2 + 1$ when selecting the random number q for any backoff(s) that precede the Channel Occupancy that may exceed 6 ms or which follow the Channel Occupancy that exceeded 6 ms. The choice between preceding or following a Channel Occupancy shall remain unchanged during the operation time of the device.

NOTE 3: The values for p_0 , CW_{min} , CW_{max} are minimum values. Greater values are allowed.

Table 2: Priority Class dependent Channel Access parameters for Supervised Devices

Class #	p_0	CW_{min}	CW_{max}	maximum Channel Occupancy Time (COT)
4	1	3	7	2 ms
3	1	7	15	4 ms
2	3	15	63	6 ms (see note 1 and note 2)
1	7	15	1 023	6 ms (see note 1)

Note 1: The maximum *Channel Occupancy Time* (COT) of 6 ms may be increased to 8 ms by inserting one or more pauses. The minimum duration of a pause shall be 100 μ s. The maximum duration (Channel Occupancy) before including any such pause shall be 6 ms. Pause duration is not included in the channel occupancy time.

Note 2: The maximum Channel Occupancy Time (COT) of 6 ms may be increased to 10 ms by extending CW to $CW \times 2 + 1$ when selecting the random number q for any backoff(s) that precede the Channel Occupancy that may exceed 6 ms or which follow the Channel Occupancy that exceeded 6 ms. The choice between preceding or following a Channel Occupancy shall remain unchanged during the operation time of the device.

Note 3: The values for p_0 , CW_{min} , CW_{max} are minimum values. Greater values are allowed.

Table 3: Classification of Idle Periods dependent Priority Class for Supervising Devices

Class #	Idle Periods Classification
4	$B_n = \begin{cases} [0, 23[\mu s, & n = 0 \\ [23 + 9 \times (n - 1), 23 + 9 \times n[\mu s, & 1 \leq n \leq 3 \\ [50, \infty[\mu s, & n = 4 \end{cases}$
3	$B_n = \begin{cases} [0, 23[\mu s, & n = 0 \\ [23 + 9 \times (n - 1), 23 + 9 \times n[\mu s, & 1 \leq n \leq 7 \\ [86, \infty[\mu s, & n = 8 \end{cases}$
2	$B_n = \begin{cases} [0, 41[\mu s, n = 0 \\ [41 + 9 \times (n - 1), 41 + 9 \times n[\mu s, 1 \leq n \leq 31 \text{ (use of note 2 in table 1)} \\ [320, \infty[\mu s, n = 32 \end{cases}$ $B_n = \begin{cases} [0, 41[\mu s, n = 0 \\ [41 + 9 \times (n - 1), 41 + 9 \times n[\mu s, 1 \leq n \leq 15 \text{ (not use of note 2 in table 1)} \\ [176, \infty[\mu s, n = 16 \end{cases}$
1	$B_n = \begin{cases} [0, 77[\mu s, n = 0 \\ [77 + 9 \times (n - 1), 77 + 9 \times n[\mu s, 1 \leq n \leq 15 \\ [212, \infty[\mu s, n = 16 \end{cases}$

Table 4: Classification of Idle Periods dependent Priority Class for Supervised Devices

Class #	Idle Periods Classification
4	$B_n = \begin{cases} [0, 32[\mu\text{s}, & n = 0 \\ [32 + 9 \times (n - 1), 32 + 9 \times n[\mu\text{s}, & 1 \leq n \leq 3 \\ [59, \infty[\mu\text{s}, & n = 4 \end{cases}$
3	$B_n = \begin{cases} [0, 32[\mu\text{s}, & n = 0 \\ [32 + 9 \times (n - 1), 32 + 9 \times n[\mu\text{s}, & 1 \leq n \leq 7 \\ [95, \infty[\mu\text{s}, & n = 8 \end{cases}$
2	$B_n = \begin{cases} [0, 41[\mu\text{s}, & n = 0 \\ [41 + 9 \times (n - 1), 41 + 9 \times n[\mu\text{s}, & 1 \leq n \leq 15 \\ [176, \infty[\mu\text{s}, & n = 16 \end{cases}$
1	$B_n = \begin{cases} [0, 77[\mu\text{s}, & n = 0 \\ [77 + 9 \times (n - 1), 77 + 9 \times n[\mu\text{s}, & 1 \leq n \leq 15 \\ [212, \infty[\mu\text{s}, & n = 16 \end{cases}$



Table 5: Idle Periods probability dependent Priority Class

Class #	Idle Periods probability
4	$p(n) \leq \begin{cases} 0,05, & n = 0 \\ 0,05 + n \times 0,25, & 1 \leq n \leq 3 \\ 1, & n > 3 \end{cases}$
3	$p(n) \leq \begin{cases} 0,05, & n = 0 \\ 0,18, & n = 1 \\ 0,18 + (n - 1) \times 0,125, & 2 \leq n \leq 6 \\ 1, & n > 6 \end{cases}$
2	$p(n) \leq \begin{cases} 0,05, & n = 0 \\ 0,12, & n = 1 \\ 0,12 + (n - 1) \times 0,03125, & 2 \leq n \leq 29 \end{cases} \text{ (use of note 2 in table 2)}$ $p(n) \leq \begin{cases} 0,05, & n = 0 \\ 0,12, & n = 1 \\ 0,12 + (n - 1) \times 0,0625, & 2 \leq n \leq 15 \end{cases} \text{ (make sure not use of note 2 in table 2)}$ $p(n) \leq \begin{cases} 0,05, & n = 0 \\ 0,09 + (n - 1) \times 0,03125, & 1 \leq n \leq 7 \\ 0,59 + (n - 1) \times 0,03125, & 8 \leq n \leq 14 \end{cases} \text{ (use of note 1 in table 2)}$
1	$p(n) \leq \begin{cases} 0,05, & n = 0 \\ 0,12, & n = 1 \\ 0,12 + (n - 1) \times 0,0625, & 2 \leq n \leq 15 \\ 1, & n > 15 \end{cases}$
<p>1. E define the total number of Idle Periods observed. Then E is the sum of events in all bins:</p> $E = \sum_{n=0}^k H(B_n)$ <p>2. p(n) define the probability that idle periods of duration less than the upper limit specified for bin B_n occurred, p(n) = p (Idle Period < upper limit of bin B_n)</p> $p(n) = \frac{\sum_{i=0}^n H(B_i)}{E}$	

3.5.3 TEST PROCEDURE

Reference to ETSI EN 301 893 V2.1.1 clause 5.4.9

Measurement Method	
<input checked="" type="checkbox"/> Conducted measurement	<input type="checkbox"/> Radiated measurement

3.5.4 TEST SETUP CONFIGURATION

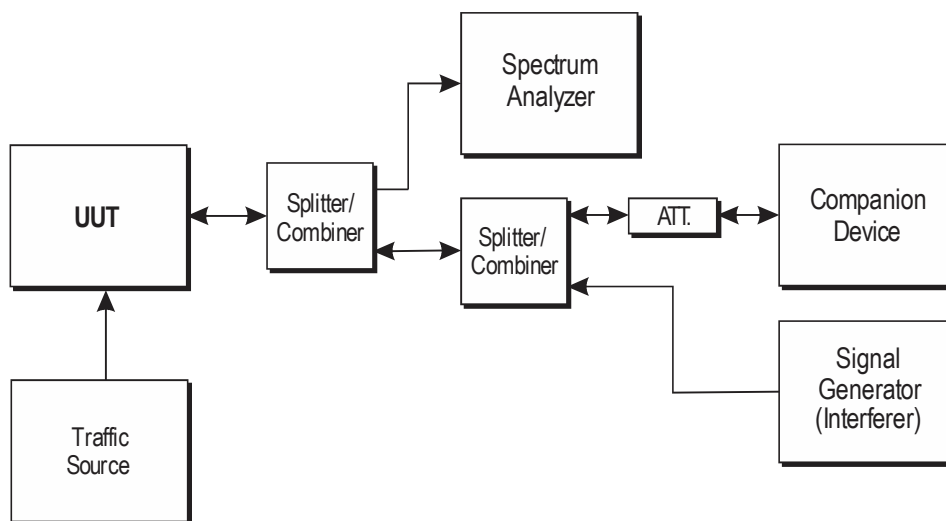

UUT SOFTWARE AND FIRMWARE VERSION

PRODUCT	MODEL NO.	SOFTWARE/FIRMWARE VERSION
M SoM	M404	BG95M5LAR02A03/ N/A

Companion Device information

PRODUCT	BRAND	MODEL NO.	SOFTWARE/FIRMWARE VERSION
wireless router	TP-LINK	TL-WVR1200G	N/A

3.5.5 LIST OF MEASUREMENTS

Clause	Test Parameter	Remarks	Pass/Fail
4.2.7.3.1	Adaptive (Frame Based Equipment)	Not Applicable	NA
4.2.7.3.2	Adaptive (Load Based Equipment)	Applicable	Pass
4.2.7.3.3	Short Control Signalling Transmissions	Applicable	Pass

3.5.6 INTERFERENCE THRESHOLD LEVEL

Energy Detection Threshold Level(TL)	
Option 1: TL = -75 dBm/MHz (assumes a 0 dBi receive antenna)	
UUT antenna Gain(G) : 6.8 dBi	<input checked="" type="checkbox"/> at the antenna connector
The ED Threshold level (TL) = -75 dBm/MHz + 6.8dBi=-68.20 dBm/MHz	<input type="checkbox"/> in front of the antenna

Additive White Gaussian Noise (AWGN) test signal Bandwidth

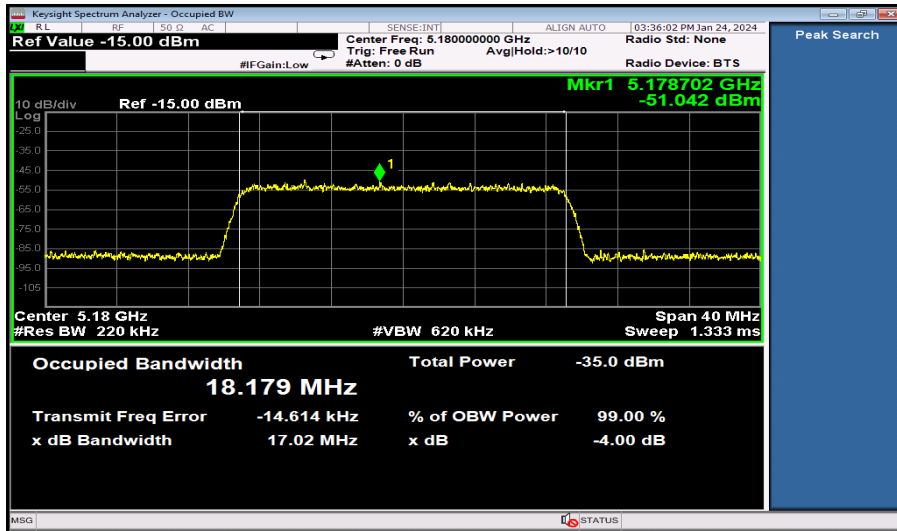

Additive White Gaussian Noise (AWGN) test signal level

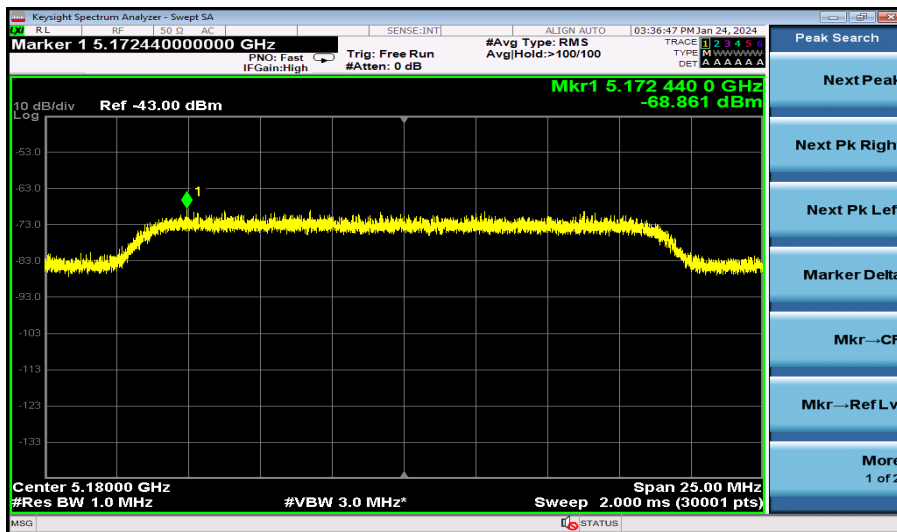

OFDM test signal Bandwidth

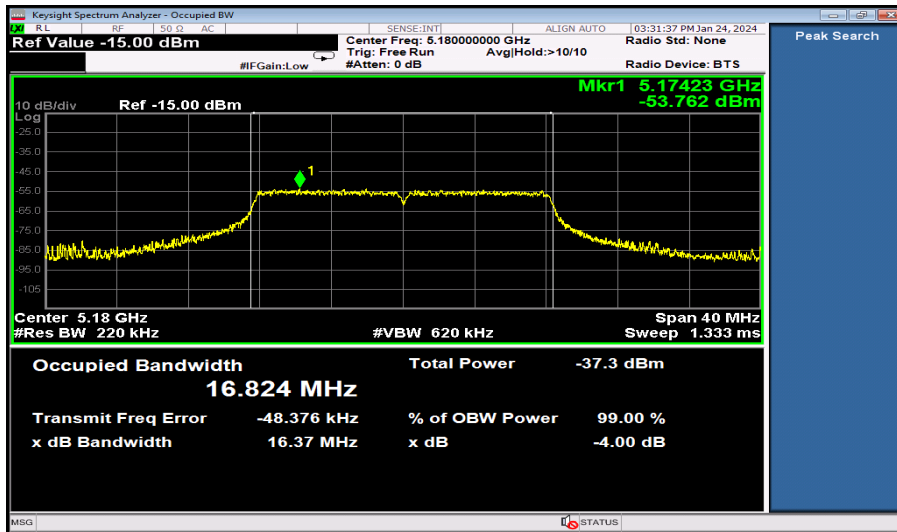

OFDM test signal level:

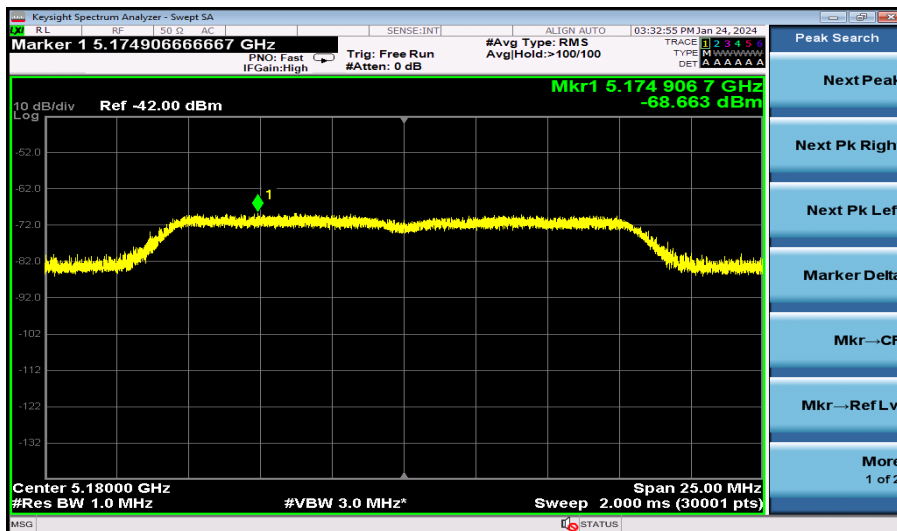

Additive LTE test signal bandwidth

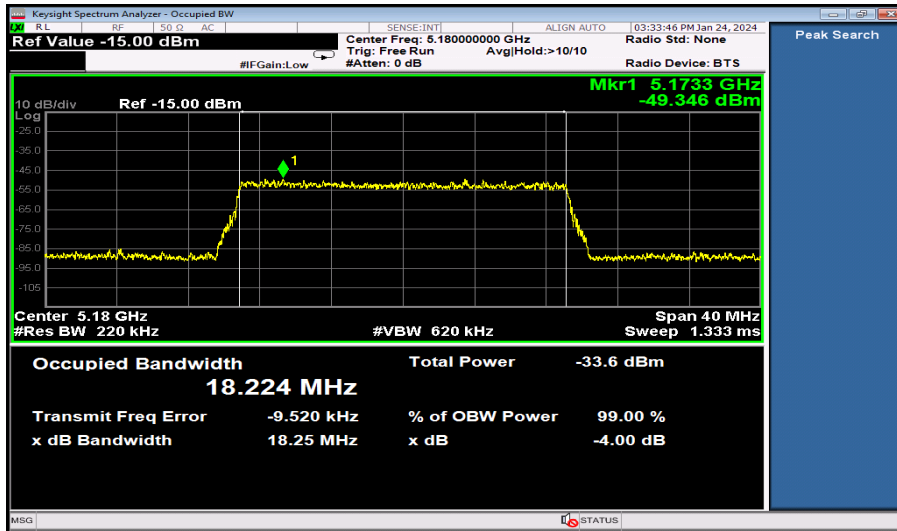

Additive LTE test signal Level

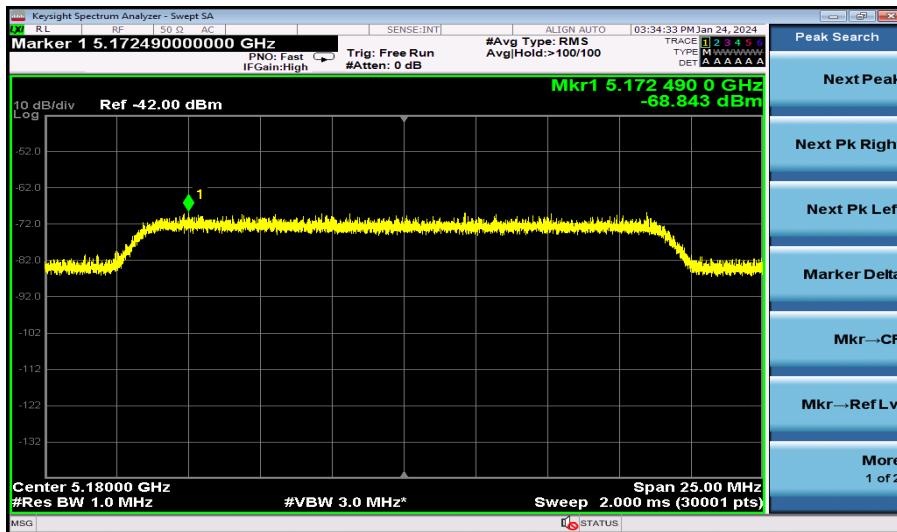

3.5.7 TEST RESULT

3.5.7.1 ADAPTIVITY TEST RESULT

Channel Operation of EUT Device type

Operational Mode	Operating Frequency (MHz)
802.11a	5180
802.11n (HT40)	5190
Test Result	PASS

<input type="checkbox"/> Frame Based Equipment	<input type="checkbox"/> Single Channel Operation
	<input type="checkbox"/> Multi-Channel Operation
<input checked="" type="checkbox"/> Load Based Equipment	<input checked="" type="checkbox"/> Single Channel Operation
	<input type="checkbox"/> Option 1 for Multi-Channel Operation
	<input checked="" type="checkbox"/> Option 2 for Multi-Channel Operation

3.5.7.2 OPERATING FREQUENCY BANDS AND MODE OF EUT

Operational Mode	Operating Frequency (MHz)	Test Result
802.11a	5180	Pass
802.11n (HT40)	5190	Pass

Single-Channel Operation

Test Case: Adaptivity-AWGN on

Mode: 802.11a	Ant: PCB
Channel: 5180	Voltage: DC 3.8V
Temperature: 25°C	

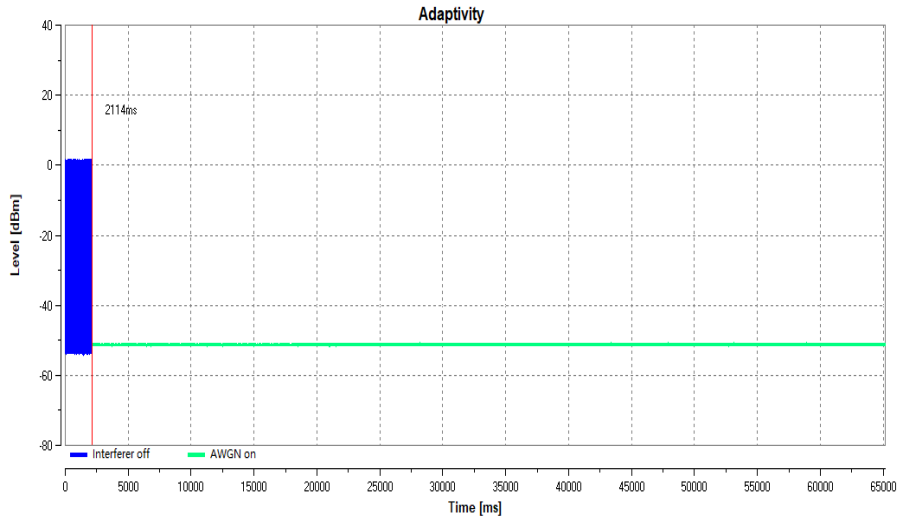

Short Control Signalling Time:0.00ms

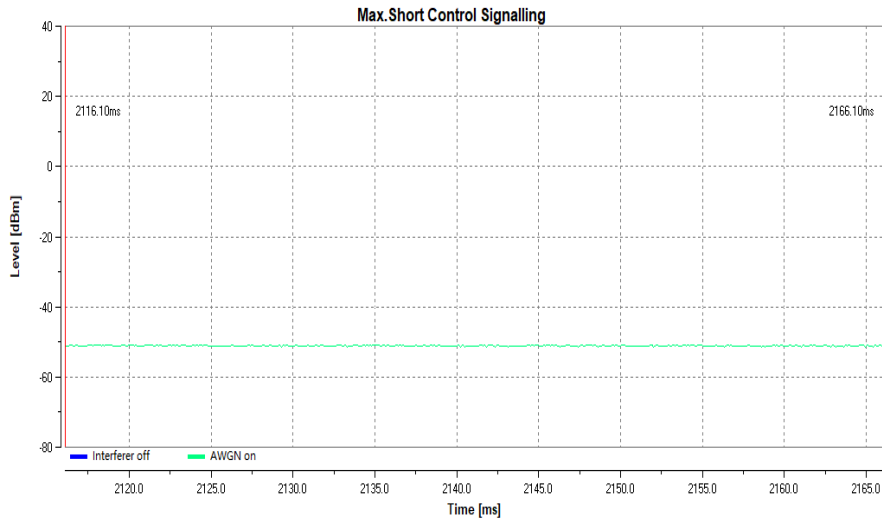

Test Case: Adaptivity-OFDM On

Mode: 802.11a	Ant: PCB
Channel: 5180	Voltage: Voltage: DC 3.8V
Temperature: 25°C	

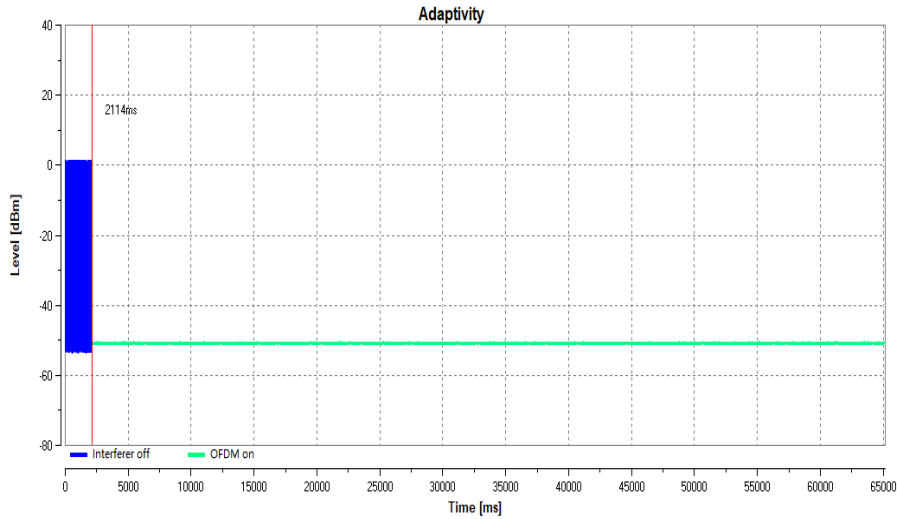

Short Control Signalling Time:0.0ms

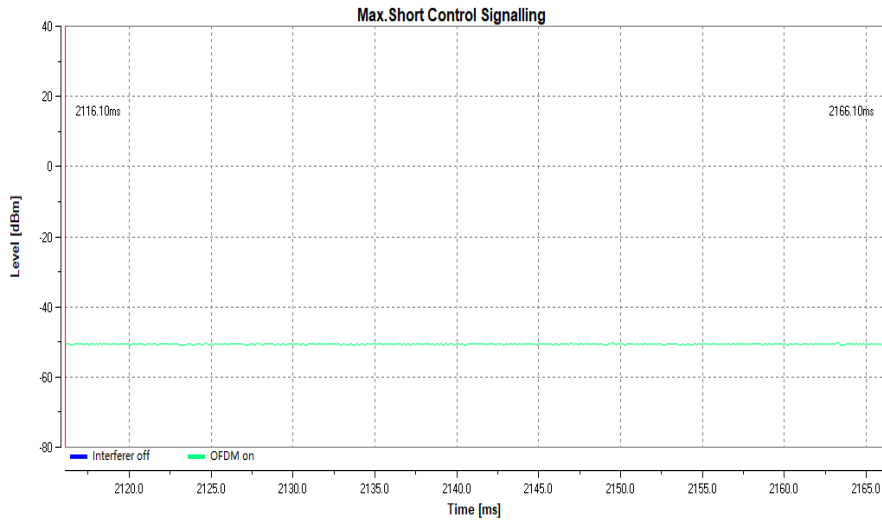

Test Case: Adaptivity-LTEOn

Mode: 802.11a	Ant: PCB
Channel: 5180	Voltage: Voltage: DC 3.8V
Temperature: 25°C	

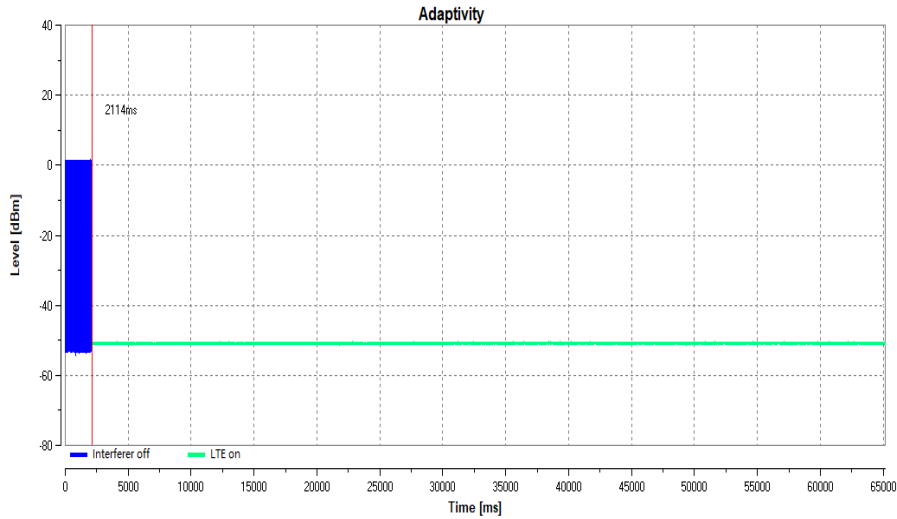

.Short Control Signalling Time:0.00ms

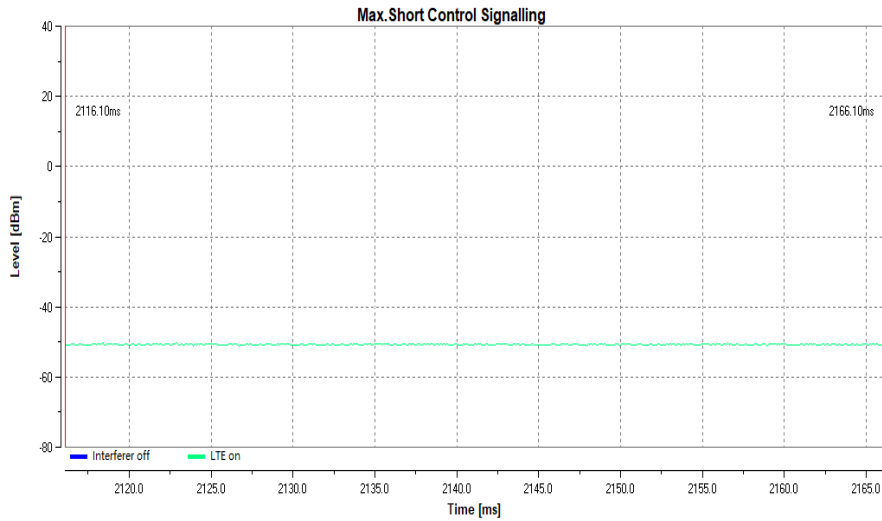

Multi-Channel Operation

Test Case: Adaptivity-AWGN On

Mode: 802.11ac(VHT80)	Ant: PCB
Channel: 5190	Voltage: DC 3.8V
Temperature: 25°C	

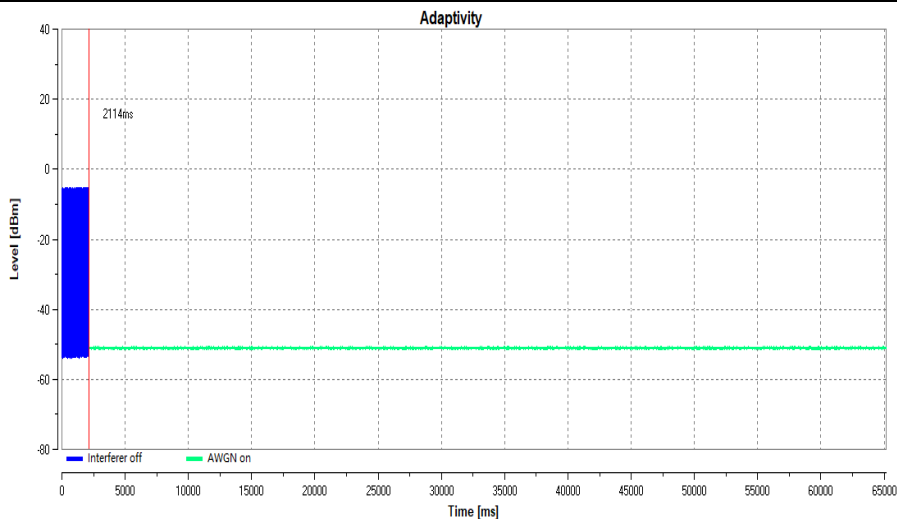

.Short Control Signalling Time:0.0ms

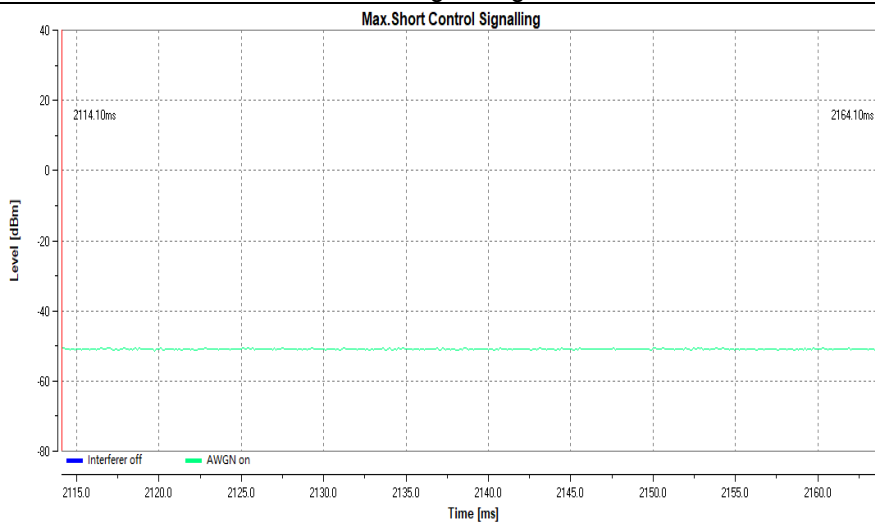

3.5.7.3 TEST RESULTS OF MEDIUM ACCESS MECHANISM

Medium Access Mechanism of EUT type

<input type="checkbox"/> Frame Based Equipment	
<input checked="" type="checkbox"/> Load Based Equipment	<input checked="" type="checkbox"/> Option A : verify medium access mechanism
	<input type="checkbox"/> Option B : declatation by manufacturer
<input checked="" type="checkbox"/> Priority Class Dependent Channel Access parameters: 2	

Operating Frequency Bands and Mode of EUT

Operational Mode	Operating Frequency (MHz)	Maximum Channel Occupancy Time (ms)	Minimum Idle Period (μs)	Test Result
802.11a	5180	2.098	43	Pass

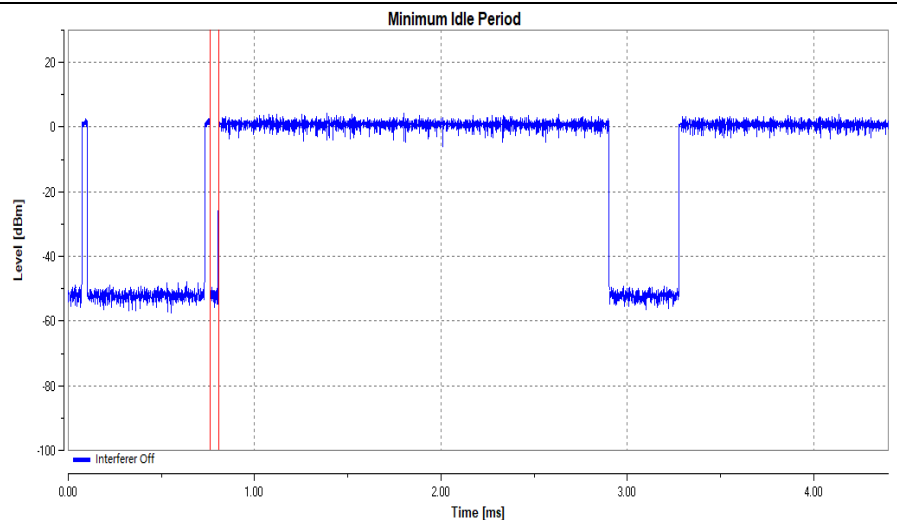
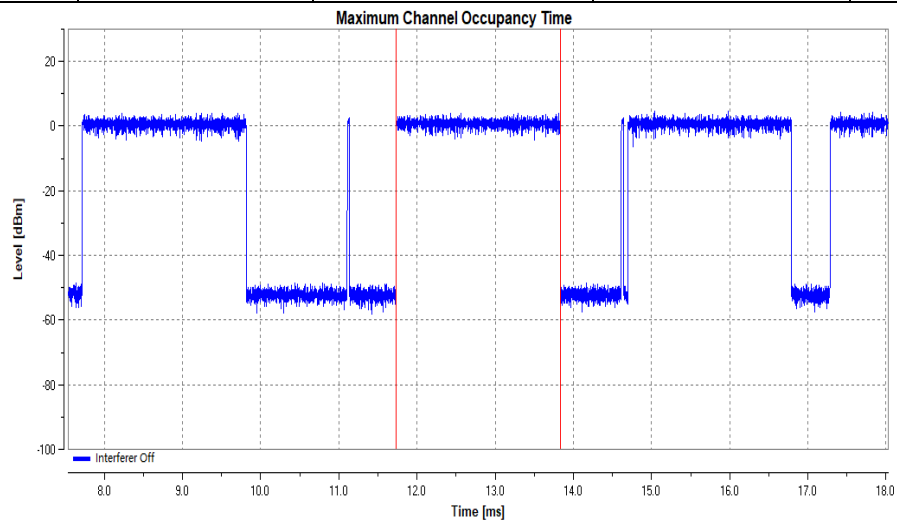

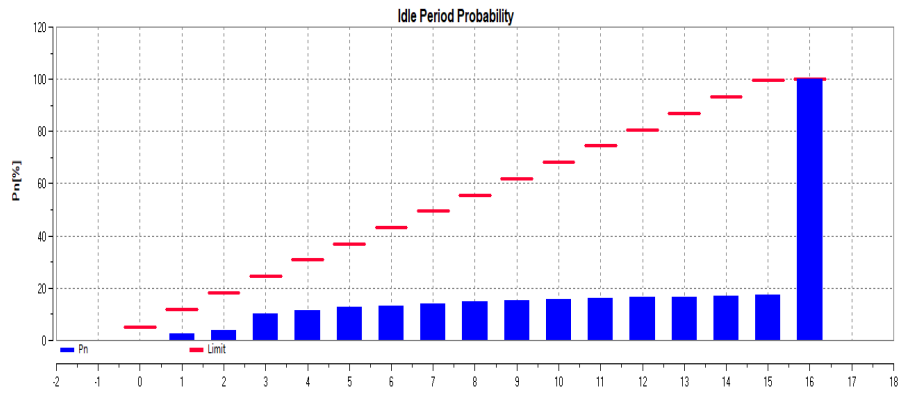



3.6 MEDIUM ACCESS PROTOCOL

3.6.1 DEFINITION

A medium access protocol is a mechanism designed to facilitate spectrum sharing with other devices in the wireless network.

3.6.2 REQUIREMENT

A medium access protocol shall be implemented by the equipment and shall be active under all circumstances.

Manufacturer provides declaration form to meet this requirement.

3.7 USER ACCESS RESTRICTIONS

3.7.1 DEFINITION

User Access Restrictions are restraints implemented in the RLAN to restrict access for the user to certain hardware and/or software settings of the equipment.

3.7.2 REQUIREMENT

DFS controls (hardware or software) related to radar detection shall not be accessible to the user so that the DFS requirements described in clauses 5.4.8.2.1.1 to 5.4.8.2.1.6 can neither be disabled nor altered.

Manufacturer provides declaration form to meet this requirement.

3.8 TRANSMITTER UNWANTED EMISSIONS OUTSIDE THE 5 GHz RLAN BANDS

3.8.1 LIMITS OF UNWANTED CONDUCTED EMISSIONS OUTSIDE THE 5 GHz RLAN BANDS

Frequency Range (MHz)	Maximum power (dBm)	Bandwidth (kHz)
30 to 47	-36	100
47 to 74	-54	100
74 to 87.5	-36	100
87.5 to 118	-54	100
118 to 174	-36	100
174 to 230	-54	100
230 to 470	-36	100
470 to 862	-54	100
862 to 1000	-36	100
Frequency Range (GHz)	Maximum power (dBm)	Bandwidth (MHz)
1 to 5.15	-30	1
5.35 to 5.47	-30	1
5.725 to 26	-30	1

3.8.2 TEST PROCEDURES

Reference to ETSI EN 301 893 V2.1.1 clause 5.4.5

3.8.3 DEVIATION FROM TEST STANDARD

No deviation.



3.8.4 TEST SETUP

The test setup has been constructed as the normal use condition. The EUT has been connected to Notebook Computer and placed on the turn-table. Controlling software has been activated to set the EUT on specific status.

For the actual test configuration, please refer to the related Item in this test report (Photographs of the Test Configuration).

NOTE:

1. The resolution bandwidth and video bandwidth of test receiver/spectrum analyzer is 100kHz for Quasi-peak detection at frequency below 1GHz.
2. The resolution bandwidth of test receiver/spectrum analyzer is 1MHz and video bandwidth is 3MHz for Peak detection at frequency above 1GHz.
3. All modes of operation were investigated and the worst-case emissions are reported.

3.8.5 TEST RESULTS

**BELOW 1GHz WORST-CASE DATA:
802.11a**

SPURIOUS EMISSION FREQUENCY RANGE	30MHz ~ 1GHz	OPERATING CHANNEL	36
--	--------------	--------------------------	----

SPURIOUS EMISSION LEVEL				
Frequency (MHz)	Antenna Polarization	Level (dBm)	Limit (dBm)	Margin (dB)
107.66	H	-82.32	-54.00	-28.32
230.95	H	-72.28	-36.00	-36.28
249.96	H	-77.19	-36.00	-41.19
350.07	H	-80.33	-36.00	-44.33
370.34	H	-78.63	-36.00	-42.63
475.78	H	-79.03	-54.00	-25.03

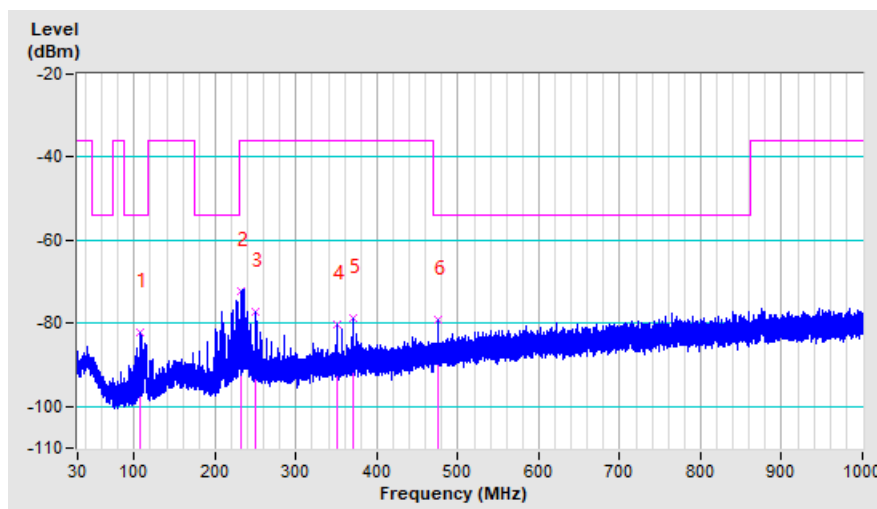

SPURIOUS EMISSION FREQUENCY RANGE	30MHz ~ 1GHz	OPERATING CHANNEL	36
--	--------------	--------------------------	----

SPURIOUS EMISSION LEVEL				
Frequency (MHz)	Antenna Polarization	Level (dBm)	Limit (dBm)	Margin (dB)
210.61	V	-77.59	-54.00	-23.59
234.90	V	-77.60	-36.00	-41.60
260.99	V	-77.00	-36.00	-41.00
336.13	V	-77.61	-36.00	-41.61
359.44	V	-75.92	-36.00	-39.92
375.87	V	-75.09	-36.00	-39.09

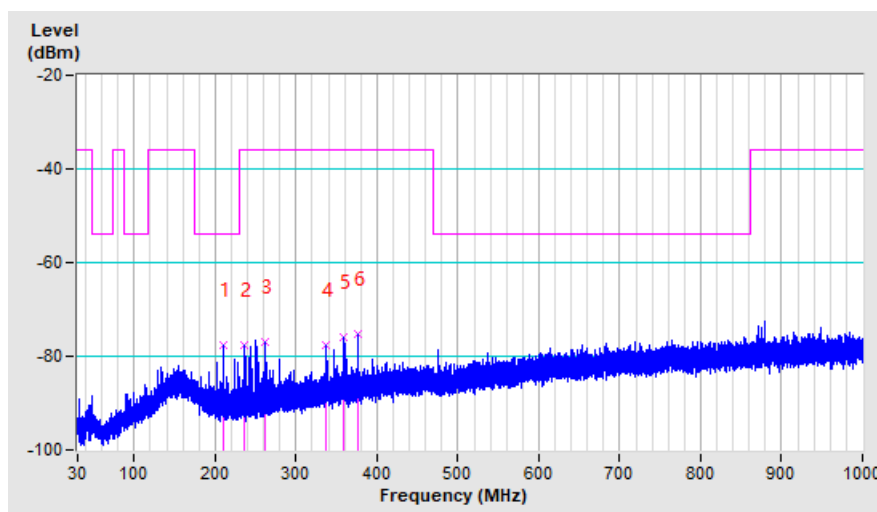

ABOVE 1GHz DATA:

802.11a

SPURIOUS EMISSION FREQUENCY RANGE	1GHz ~ 26GHz	OPERATING CHANNEL	36, 64, 100, 140
--	--------------	------------------------------	------------------

SPURIOUS EMISSION LEVEL					
Channel	Frequency (MHz)	Antenna Polarization	Level (dBm)	Limit (dBm)	Margin (dB)
36	10360.00	H	-41.52	-30.00	-11.52
	10360.00	V	-41.51	-30.00	-11.51
	15540.00	H	-41.30	-30.00	-11.30
	15540.00	V	-40.36	-30.00	-10.36
64	10640.00	H	-42.78	-30.00	-12.78
	10640.00	V	-42.86	-30.00	-12.86
	15960.00	H	-43.10	-30.00	-13.10
	15960.00	V	-43.33	-30.00	-13.33
100	11000.00	H	-42.17	-30.00	-12.17
	11000.00	V	-42.28	-30.00	-12.28
	16500.00	H	-40.29	-30.00	-10.29
	16500.00	V	-45.11	-30.00	-15.11
140	11400.00	H	-40.26	-30.00	-10.26
	11400.00	V	-40.99	-30.00	-10.99
	17100.00	H	-41.35	-30.00	-11.35
	17100.00	V	-42.18	-30.00	-12.18

802.11n (HT20)

SPURIOUS EMISSION FREQUENCY RANGE	1GHz ~ 26GHz	OPERATING CHANNEL	36, 64, 100, 140
--	--------------	------------------------------	------------------

SPURIOUS EMISSION LEVEL					
Channel	Frequency (MHz)	Antenna Polarization	Level (dBm)	Limit (dBm)	Margin (dB)
36	10360.00	H	-43.20	-30.00	-13.20
	10360.00	V	-40.78	-30.00	-10.78
	15540.00	H	-40.02	-30.00	-10.02
	15540.00	V	-42.17	-30.00	-12.17
64	10640.00	H	-41.32	-30.00	-11.32
	10640.00	V	-42.41	-30.00	-12.41
	15960.00	H	-42.64	-30.00	-12.64
	15960.00	V	-41.33	-30.00	-11.33
100	11000.00	H	-42.10	-30.00	-12.10
	11000.00	V	-42.51	-30.00	-12.51
	16500.00	H	-41.26	-30.00	-11.26
	16500.00	V	-44.26	-30.00	-14.26
140	11400.00	H	-40.20	-30.00	-10.20
	11400.00	V	-42.20	-30.00	-12.20
	17100.00	H	-41.70	-30.00	-11.70
	17100.00	V	-51.94	-30.00	-21.94

802.11n (HT40)

SPURIOUS EMISSION FREQUENCY RANGE	1GHz ~ 26GHz	OPERATING CHANNEL	38, 62, 102, 134
--	--------------	------------------------------	------------------

SPURIOUS EMISSION LEVEL					
Channel	Frequency (MHz)	Antenna Polarization	Level (dBm)	Limit (dBm)	Margin (dB)
38	10380.00	H	-41.58	-30.00	-11.58
	10380.00	V	-40.78	-30.00	-10.78
	15570.00	H	-43.83	-30.00	-13.83
	15570.00	V	-43.63	-30.00	-13.63
62	10620.00	H	-41.06	-30.00	-11.06
	10620.00	V	-42.98	-30.00	-12.98
	15930.00	H	-43.05	-30.00	-13.05
	15930.00	V	-42.93	-30.00	-12.93
102	11020.00	H	-42.59	-30.00	-12.59
	11020.00	V	-41.54	-30.00	-11.54
	16530.00	H	-41.36	-30.00	-11.36
	16530.00	V	-42.03	-30.00	-12.03
134	11340.00	H	-40.85	-30.00	-10.85
	11340.00	V	-41.68	-30.00	-11.68
	17010.00	V	-42.10	-30.00	-12.10
	17101.00	H	-43.44	-30.00	-13.44

3.9 TRANSMITTER UNWANTED EMISSIONS WITHIN THE 5GHZ RLAN BANDS

3.9.1 LIMITS OF UNWANTED EMISSIONS WITHIN THE 5GHZ RLAN BANDS

The average level of the transmitted spectrum shall not exceed the limits given in the following figure:

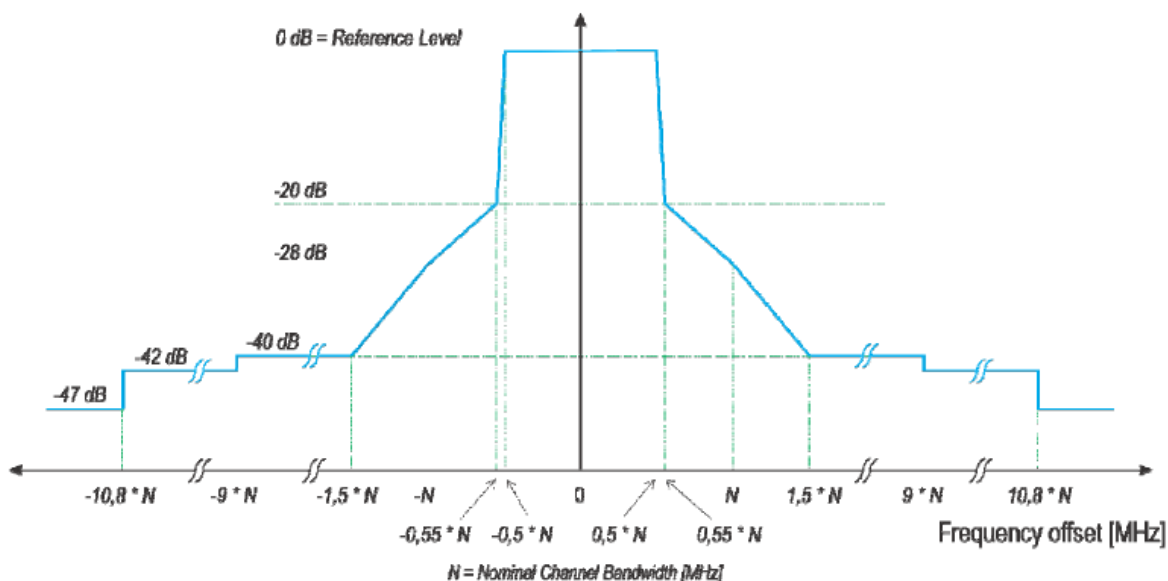

NOTE: dBc is the spectral density relative to the maximum spectral power density of the transmitted signal.

3.9.2 TEST PROCEDURES

Reference to ETSI EN 301 893 V2.1.1 clause 5.4.6

3.9.3 DEVIATION FROM TEST STANDARD

No deviation



3.9.4 TEST SETUP

The test setup has been constructed as the normal use condition. The EUT shall be connected to spectrum analyzer. Controlling software has been activated to set the EUT on specific status.

1. Set resolution bandwidth (RBW) = 1MHz
2. Set the video bandwidth (VBW) = 30KHz
3. Detector = RMS.
4. Trace mode = max hold. Trigger Mode = Video Trigger
5. Sweep Point= 5000, Sweep time = 1min
6. Start Frequency=5150MHz, Stop Frequency=5725MHz

3.9.5 TEST RESULTS

802.11a

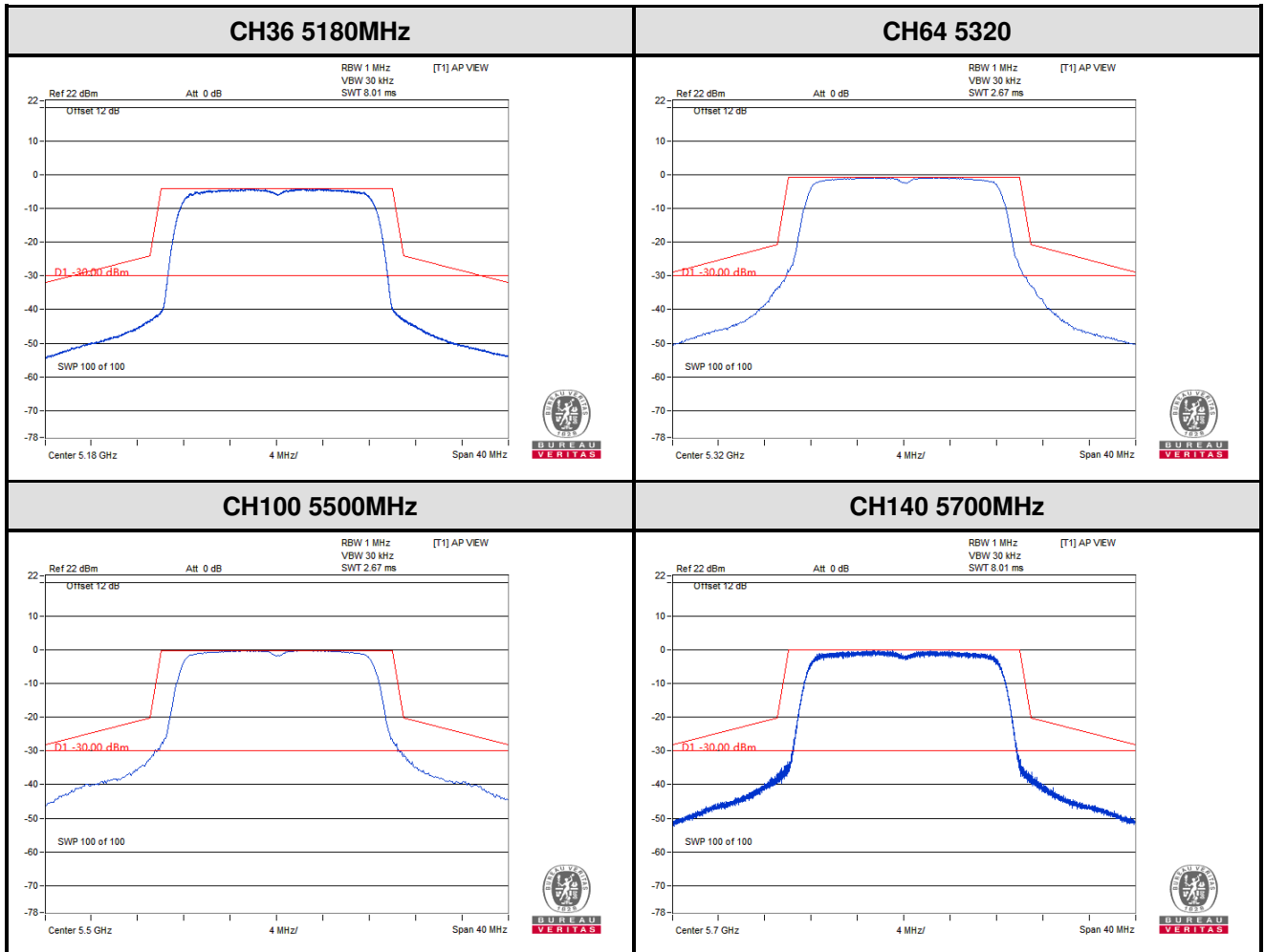

802.11n (HT20)

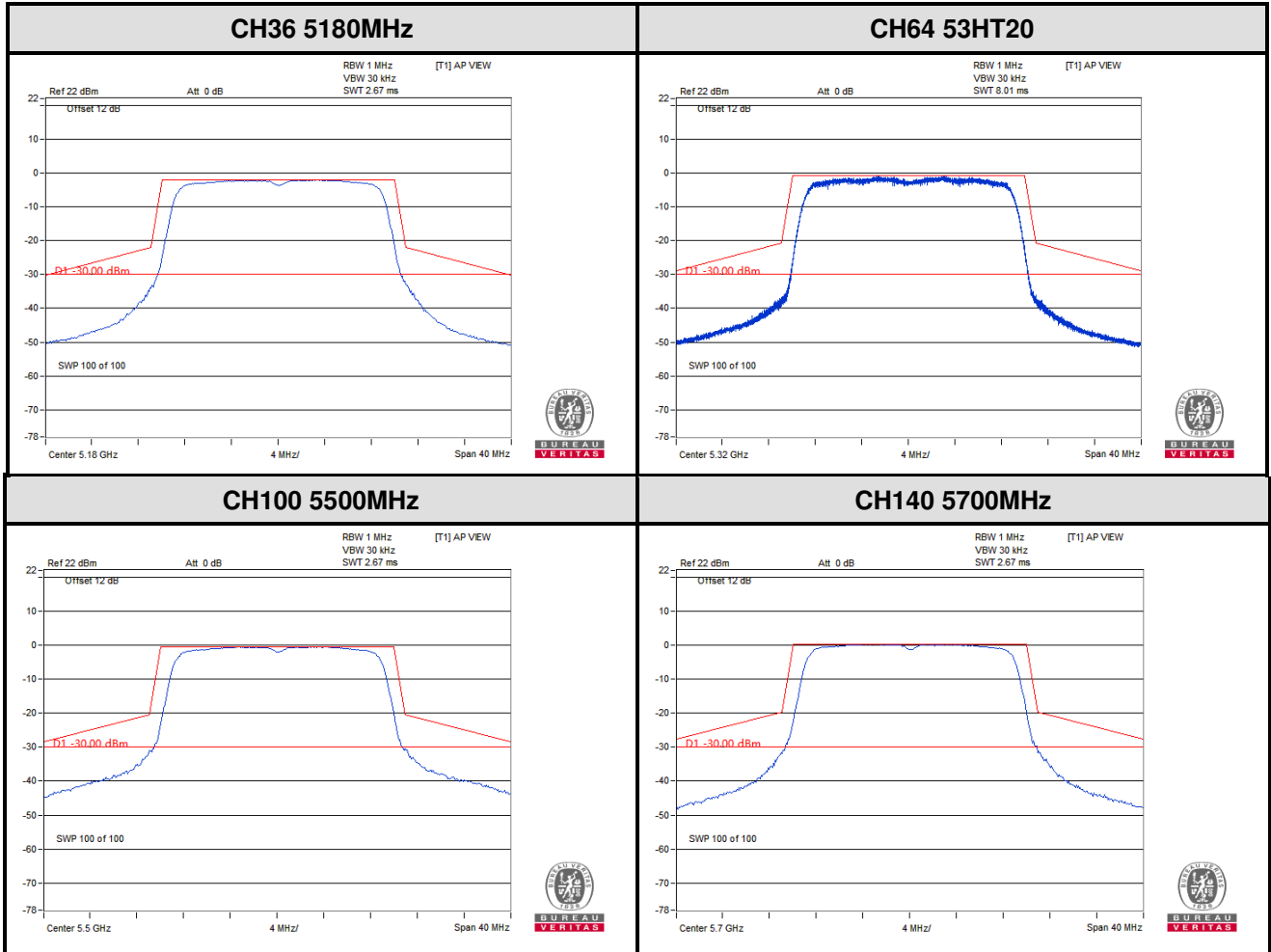

802.11n (HT40)

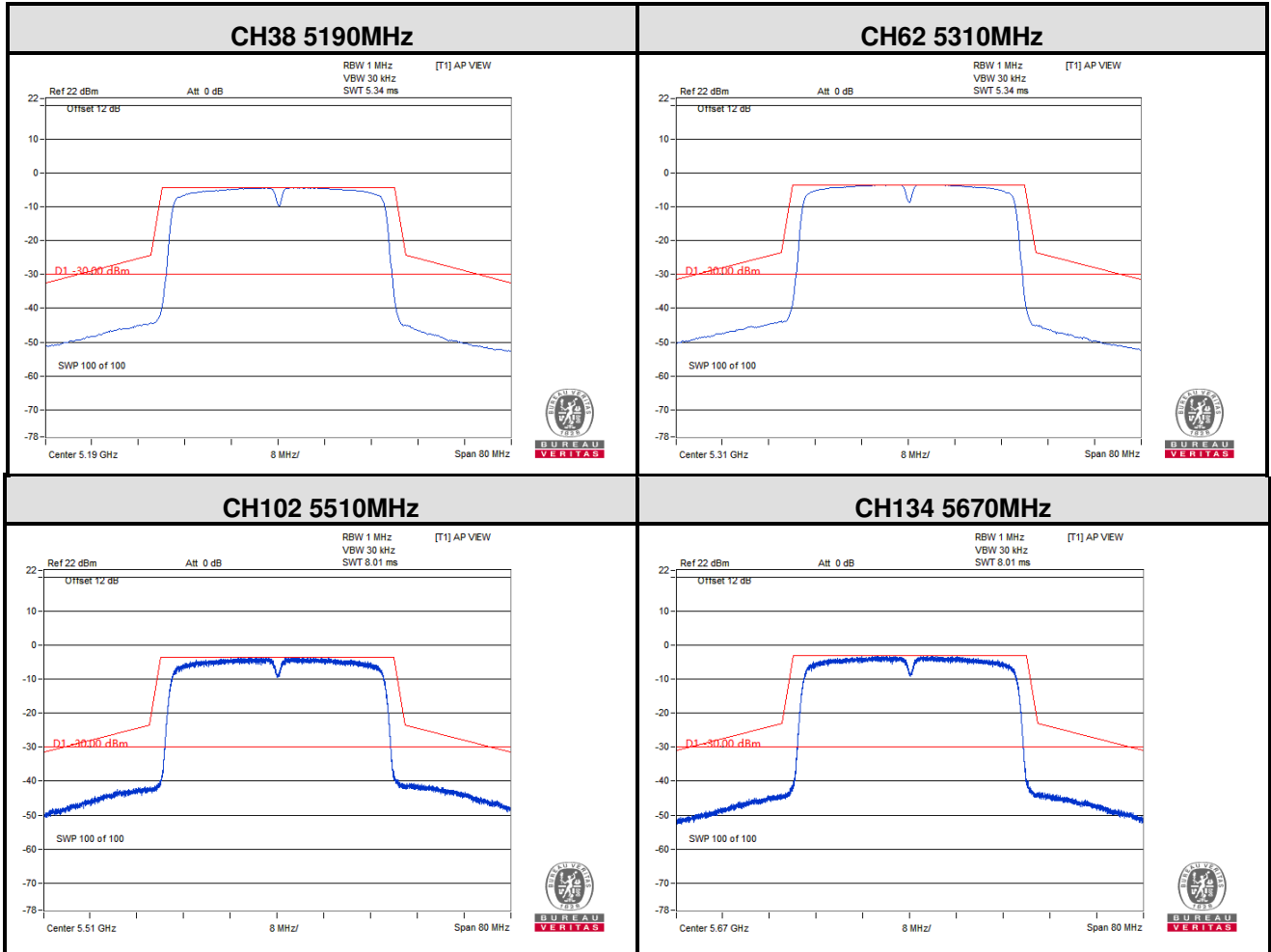

RECEIVER PARAMETERS

3.10 RECEIVER SPURIOUS EMISSIONS

3.10.1 LIMIT OF RECEIVER SPURIOUS EMISSIONS

Spurious emission limits for receivers

Frequency Band	Limit	Measurement Bandwidth
30MHz ~ 1GHz	-57dBm (e.r.p.)	100kHz
Above 1GHz ~ 26GHz	-47dBm (e.i.r.p)	1MHz

3.10.2 TEST PROCEDURES

Please refer to ETSI EN 301 893 V2.1.1 clause 5.4.7

3.10.3 DEVIATION FROM TEST STANDARD

No deviation.

3.10.4 TEST SETUP

The test setup has been constructed as the normal use condition. The EUT has been connected to Notebook Computer and placed on the turn-table. Controlling software has been activated to set the EUT on specific status.

For the actual test configuration, please refer to the related Item in this test report (Photographs of the Test Configuration).

NOTE:

1. The resolution bandwidth and video bandwidth of test receiver/spectrum analyzer is 100kHz for Quasi-peak detection at frequency below 1GHz.
2. The resolution bandwidth of test receiver/spectrum analyzer is 1MHz and video bandwidth is 3MHz for Peak detection at frequency above 1GHz.
3. All modes of operation were investigated and the worst-case emissions are reported.

3.10.5 TEST RESULTS

RX BELOW 1GHz WORST-CASE DATA: 802.11a

SPURIOUS EMISSION FREQUENCY RANGE	30MHz ~ 1GHz	OPERATING CHANNEL	36
--	--------------	--------------------------	----

SPURIOUS EMISSION LEVEL				
Frequency (MHz)	Antenna Polarization	Level (dBm)	Limit (dBm)	Margin (dB)
110.70	H	-80.42	-57.00	-23.42
202.53	H	-71.43	-57.00	-14.43
223.26	H	-68.45	-57.00	-11.45
252.97	H	-76.89	-57.00	-19.89
336.49	H	-77.02	-57.00	-20.02
533.01	H	-75.11	-57.00	-18.11

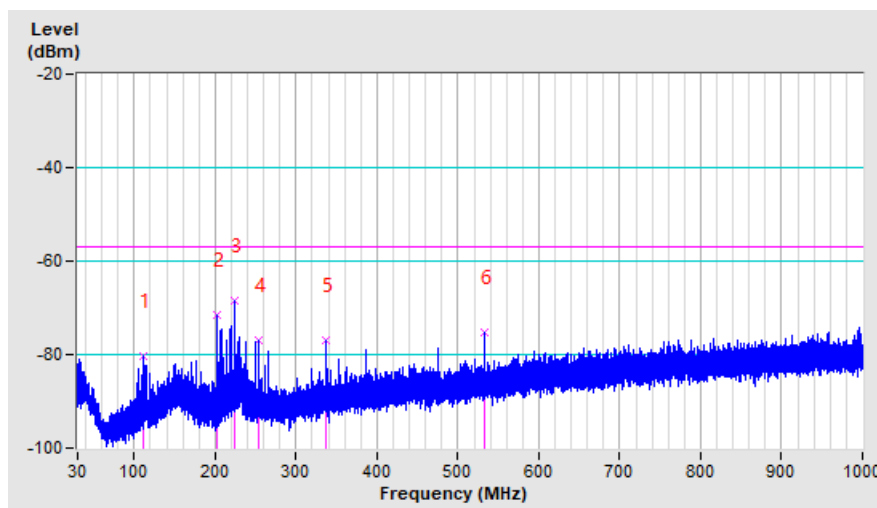

SPURIOUS EMISSION FREQUENCY RANGE	30MHz ~ 1GHz	OPERATING CHANNEL	36
--	--------------	--------------------------	----

SPURIOUS EMISSION LEVEL				
Frequency (MHz)	Antenna Polarization	Level (dBm)	Limit (dBm)	Margin (dB)
210.61	V	-77.59	-57.00	-20.59
269.91	V	-77.28	-57.00	-20.28
336.13	V	-77.61	-57.00	-20.61
359.44	V	-75.92	-57.00	-18.92
375.87	V	-75.09	-57.00	-18.09
475.78	V	-73.23	-57.00	-16.23

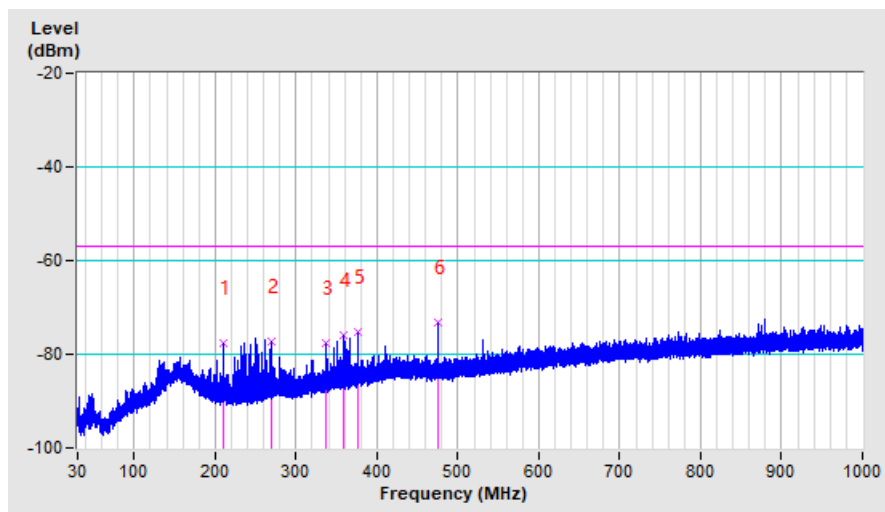



RX ABOVE 1GHz WORST-CASE DATA: 802.11a

SPURIOUS EMISSION FREQUENCY RANGE	1GHz ~ 26GHz	OPERATING CHANNEL	36, 100
--	--------------	--------------------------	---------

SPURIOUS EMISSION LEVEL					
Channel	Frequency (MHz)	Antenna Polarization	Level (dBm)	Limit (dBm)	Margin (dB)
36	10360.00	H	-55.98	-47.00	-8.98
	10360.00	V	-58.97	-47.00	-11.97
	15540.00	H	-57.26	-47.00	-10.26
	15540.00	V	-57.63	-47.00	-10.63
100	11400.00	H	-57.46	-47.00	-10.46
	11400.00	V	-59.25	-47.00	-12.25
	17100.00	H	-59.64	-47.00	-12.64
	17100.00	V	-59.25	-47.00	-12.25

3.11 RECEIVER BLOCKING

3.11.1 LIMIT OF RECEIVER BLOCKING

The minimum performance criterion shall be a PER of less than or equal to 10 %. The manufacturer may declare alternative performance criteria as long as that is appropriate for the intended use of the equipment.

Wanted signal mean power from companion device (dBm)	Blocking signal frequency (MHz)	Blocking signal power (dBm) (see note 2)		Type of blocking signal
		Master or Slave with radar detection (see table D.2, note 2)	Slave without radar detection (see table D.2, note 2)	
P _{min} + 6 dB	5 100	-53	-59	Continuous Wave
P _{min} + 6 dB	4 900 5 000 5 975	-47	-53	Continuous Wave

NOTE 1: P_{min} is the minimum level of the wanted signal (in dBm) required to meet the minimum performance criteria as defined clause 4.2.8.3 in the absence of any blocking signal.
NOTE 2: The levels specified are levels in front of the UUT antenna. In case of conducted measurements, the same levels should be used at the antenna connector irrespective of antenna gain.

3.11.2 TEST PROCEDURE

Refer to chapter 5.4.10.2.of ETSI EN 301 893 V2.1.1.

Measurement	
<input checked="" type="checkbox"/> Conducted measurement	<input type="checkbox"/> Radiated measurement

3.11.3 DEVIATION FROM TEST STANDARD

No deviation.

3.11.4 TEST SETUP CONFIGURATION

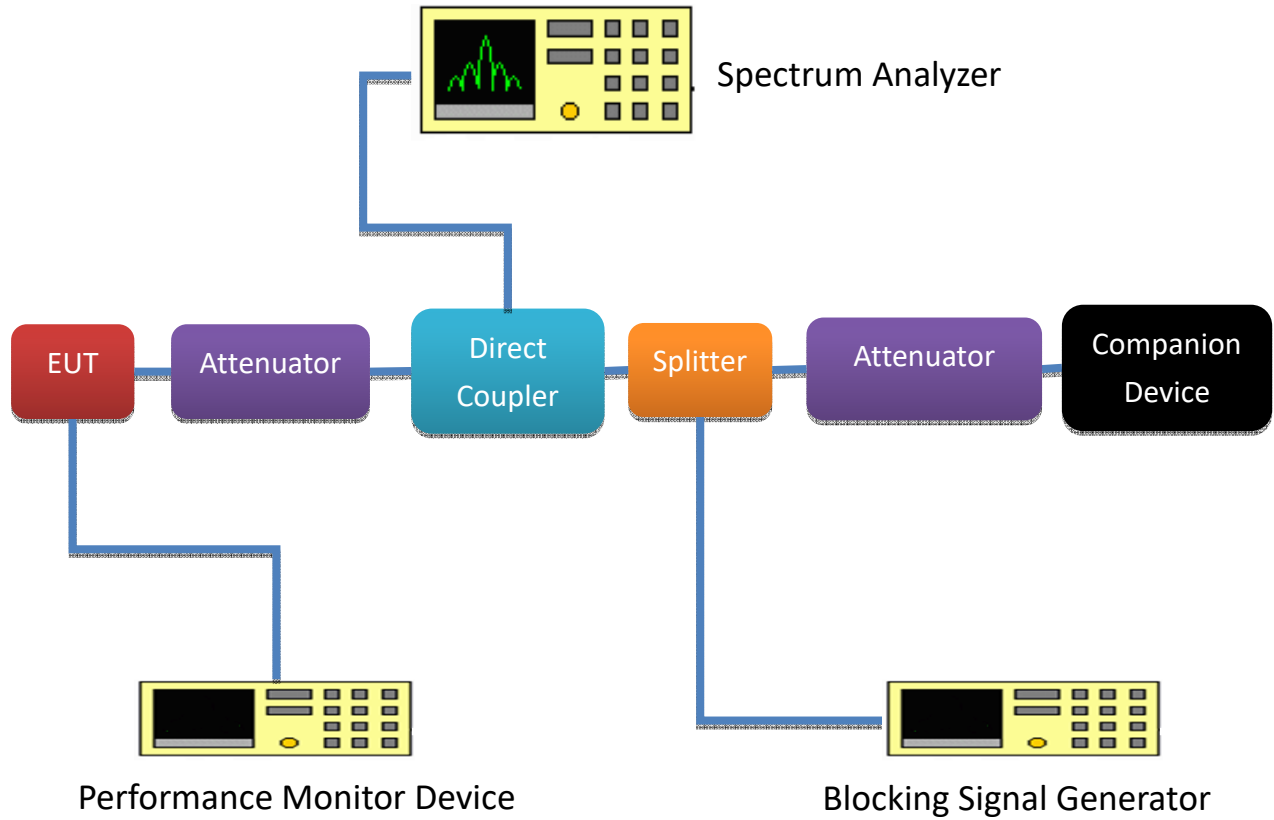

3.11.5 TEST RESULT

Receiver blocking performance when operating slave On CH36				
P _{min} : -91.23dBm				
The blocking signal power (Note)			<input checked="" type="checkbox"/> at the antenna connector <input type="checkbox"/> in front of the antenna	
Note: For the conducted measurements, the level shall be used at the antenna connector irrespective of antenna gain.				
Wanted signal mean power from companion device (dBm)	Blocking signal frequency (MHz)	The blocking signal power (dBm)	PER(%)	Pass/Fail
P _{min} + 6 dB	5100	-85.23	0.3	PASS
	4900	-85.23	0.3	PASS
	5000	-85.23	0.2	PASS
	5975	-85.23	0.4	PASS

Receiver blocking performance when operating slave On CH140				
P _{min} : -88.06dBm				
The blocking signal power (Note)			<input checked="" type="checkbox"/> at the antenna connector <input type="checkbox"/> in front of the antenna	
Note1: For the conducted measurements, the level shall be used at the antenna connector irrespective of antenna gain.				
Wanted signal mean power from companion device (dBm)	Blocking signal frequency (MHz)	The blocking signal power (dBm)	PER(%)	Pass/Fail
P _{min} + 6 dB	5100	-82.06	0.1	PASS
	4900	-82.06	0.2	PASS
	5000	-82.06	0.4	PASS
	5975	-82.06	0.1	PASS

4 PHOTOGRAPHS OF THE TEST CONFIGURATION

SPURIOUS EMISSION TEST BELOW 1GHz

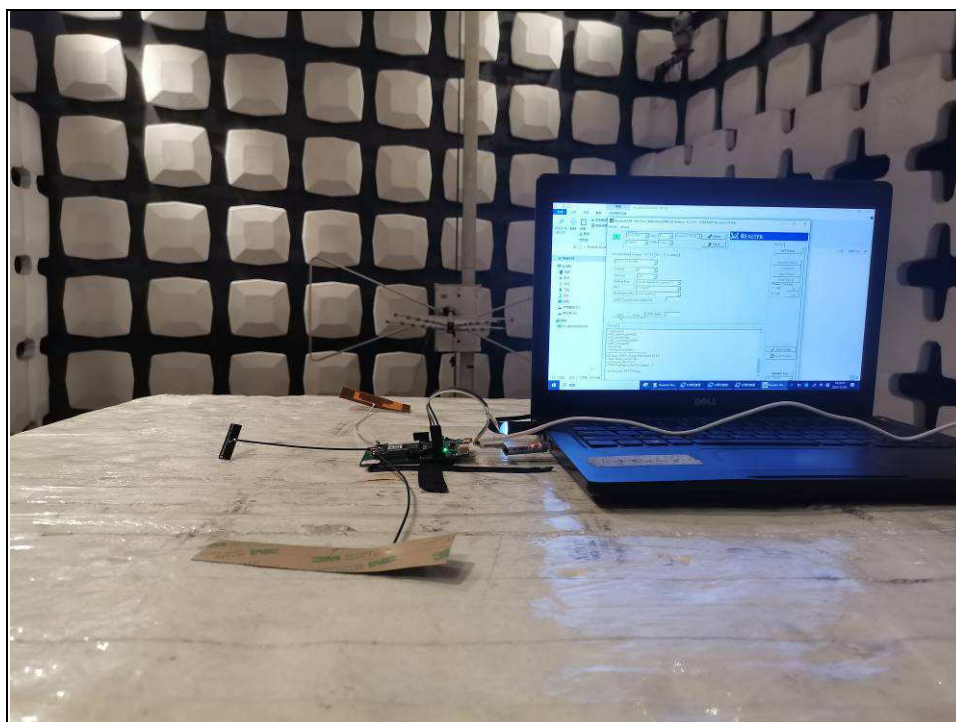

SPURIOUS EMISSION TEST ABOVE 1GHz

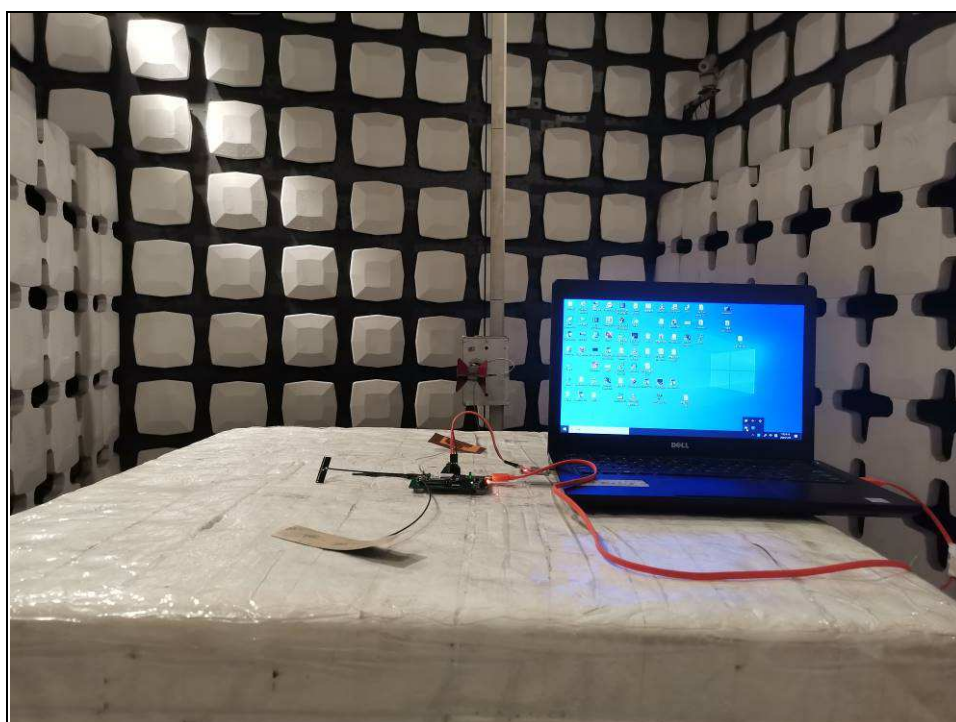

ADAPTIVITY



RECEIVING BLOCKING





Test Report No.: RE2312WDG0147-4

5 APPENDIX A – MODIFICATIONS RECORDERS FOR ENGINEERING CHANGES TO THE EUT BY THE LAB

No any modifications were made to the EUT by the lab during the test.

--- END ---