



BUREAU VERITAS

Test Report No.: W7L-P23120015RI02



IC TEST REPORT (RSS-133)



Applicant:	Particle Industries, Inc
Address:	325 9th Street, San Francisco, CA 94103, United States Of America

Manufacturer or Supplier:	Particle Industries, Inc
Address:	325 9th Street, San Francisco, CA 94103, United States Of America
Product:	M SoM
Brand Name:	Particle
Model Name:	M404
IC:	20127-M404
Date of tests:	Dec. 27, 2023 ~ Mar. 10, 2024

The tests have been carried out according to the requirements of the following standard:

- RSS-133 Issue 6, Amendment 1, January, 2018**
- RSS-Gen Issue 5, Amendment 1, March 2019**
- ANSI C63.26-2015**

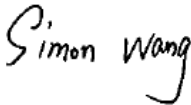
CONCLUSION: The submitted sample was found to COMPLY with the test requirement

Prepared by Simon Wang Engineer / Mobile Department	Approved by Luke Lu Manager / Mobile Department
 Date: Mar. 10, 2024	 Date: Mar. 10, 2024

This report is governed by, and incorporates by reference, the Conditions of Testing as posted at the date of issuance of this report at <http://www.bureauveritas.com/home/about-us/our-business/cps/about-us/terms-conditions/> and is intended for your exclusive use. Any copying or replication of this report to or for any other person or entity, or use of our name or trademark, is permitted only with our prior written permission. This report sets forth our findings solely with respect to the test samples identified herein. The results set forth in this report are not indicative or representative of the quality or characteristics of the lot from which a test sample was taken or any similar or identical product unless specifically and expressly noted. Our report includes all of the tests requested by you and the results thereof based upon the information that you provided to us. Measurement uncertainty is only provided upon request for accredited tests. Statements of conformity are based on simple acceptance criteria without taking measurement uncertainty into account, unless otherwise requested in writing. You have 60 days from date of issuance of this report to notify us of any material error or omission caused by our negligence or if you require measurement uncertainty; provided, however, that such notice shall be in writing and shall specifically address the issue you wish to raise. A failure to raise such issue within the prescribed time shall constitute your unqualified acceptance of the completeness of this report, the tests conducted and the correctness of the report contents.



TABLE OF CONTENTS

RELEASE CONTROL RECORD 4

1 SUMMARY OF TEST RESULTS 5

1.1 MEASUREMENT UNCERTAINTY 6

1.2 TEST SITE AND INSTRUMENTS 7

2 GENERAL INFORMATION 8

2.1 GENERAL DESCRIPTION OF EUT 8

3.1 CONFIGURATION OF SYSTEM UNDER TEST 12

3.2 DESCRIPTION OF SUPPORT UNITS 13

3.3 TEST ITEM AND TEST CONFIGURATION 13

3.4 EUT OPERATING CONDITIONS 20

3.5 GENERAL DESCRIPTION OF APPLIED STANDARDS 20

2.7 TRANSMIT ANTENNA 20

4 TEST TYPES AND RESULTS 21

4.1 OUTPUT POWER MEASUREMENT 21

4.1.1 LIMITS OF OUTPUT POWER MEASUREMENT 21

4.1.2 TEST PROCEDURES 21

4.1.3 TEST SETUP 22

4.1.4 TEST RESULTS 22

4.2 FREQUENCY STABILITY MEASUREMENT 23

4.2.1 LIMITS OF FREQUENCY STABILITY MEASUREMENT 23

4.2.2 TEST PROCEDURE 23

4.2.3 TEST SETUP 23

4.2.4 TEST RESULTS 24

4.3 OCCUPIED BANDWIDTH MEASUREMENT 25

4.3.1 TEST PROCEDURES 25

4.3.2 TEST SETUP 25

4.3.3 TEST RESULTS 26

4.4 BAND EDGE MEASUREMENT 27

4.4.1 LIMITS OF BAND EDGE MEASUREMENT 27

4.4.2 TEST SETUP 27

4.4.3 TEST PROCEDURES 28

4.4.4 TEST RESULTS 29

4.5 CONDUCTED SPURIOUS EMISSIONS 30

4.5.1 LIMITS OF CONDUCTED SPURIOUS EMISSIONS MEASUREMENT 30

4.5.2 TEST PROCEDURE 30

4.5.3 TEST SETUP 30

4.5.4 TEST RESULTS 31

4.6 RADIATED EMISSION MEASUREMENT 32

4.6.1 LIMITS OF RADIATED EMISSION MEASUREMENT 32

4.6.2 TEST PROCEDURES 32

4.6.3 DEVIATION FROM TEST STANDARD 32

4.6.4 TEST SETUP 33

4.6.5 TEST RESULTS 35

4.7 RECEIVER SPURIOUS EMISSIONS 65

4.7.1 LIMITS OF RADIATED EMISSION MEASUREMENT 65

4.7.2 TEST PROCEDURES 66

4.7.3 DEVIATION FROM TEST STANDARD 66



**BUREAU
VERITAS**

Test Report No.: W7L-P23120015R102

4.7.4	TEST SETUP	67
4.7.5	TEST RESULT	68
4.8	PEAK TO AVERAGE RATIO	69
4.8.1	LIMITS OF PEAK TO AVERAGE RATIO MEASUREMENT	69
4.8.2	TEST SETUP	69
4.8.3	TEST PROCEDURES	69
4.8.4	TEST RESULTS	70
5	INFORMATION ON THE TESTING LABORATORIES	71
6	MODIFICATIONS RECORDERS FOR ENGINEERING CHANGES TO THE EUT BY THE LAB	72
7	APPENDIX	73

DRAFT



BUREAU
VERITAS

Test Report No.: W7L-P23120015RI02

RELEASE CONTROL RECORD

ISSUE NO.	REASON FOR CHANGE	DATE ISSUED
W7L-P23120015RI02	Original release	Mar. 10, 2024

DRAFT



1 SUMMARY OF TEST RESULTS

The EUT has been tested according to the following specifications:

APPLIED STANDARD: IC RSS-133 & RSS-Gen		
STANDARD SECTION	TEST TYPE AND LIMIT	RESULT
RSS-GEN		
6.7	Occupied Bandwidth	Compliance
6.8	Transmit antenna	Compliance
STANDARD SECTION	TEST TYPE AND LIMIT	RESULT
RSS-133		
6.3	Frequency Stability AFC Freq. Error vs. Voltage AFC Freq. Error vs. Temperature	Compliance
6.4	Maximum Peak Output Power	Compliance
6.4	peak-to-average power ratio	Compliance
6.5	Band Edge Measurements	Compliance
6.5	Conducted Spurious Emissions	Compliance
6.5	Transmitter Radiated Spurious Emissions	Compliance
6.6	Receive Spurious Emissions	Compliance



1.1 MEASUREMENT UNCERTAINTY

Where relevant, the following measurement uncertainty levels have been estimated for tests performed on the EUT as specified in ETSI TR 100 028-1 V1.4.1(2001-12):

MEASUREMENT	UNCERTAINTY
Frequency Stability	±76.97Hz
Radiated emissions (9KHz~30MHz)	±2.68dB
Radiated emissions & Radiated Power (30MHz~1GHz)	±4.98dB
Radiated emissions & Radiated Power (1GHz ~6GHz)	±4.70dB
Radiated emissions (6GHz ~18GHz)	±4.60dB
Radiated emissions (18GHz ~40GHz)	±4.12dB
Conducted emissions	±4.01dB
Occupied Channel Bandwidth	±43.58KHz
Conducted Output power	±2.06dB
Band Edge Measurements	±4.70dB
Peak to average ratio	±0.76dB

This uncertainty represents an expanded uncertainty expressed at approximately the 95% confidence level using a coverage factor of k=2.

DRAFT



1.2 TEST SITE AND INSTRUMENTS

Equipment	Manufacturer	Model No.	Serial No.	Last Cal.	Next Cal.
MXE EMI Receiver	KEYSIGHT	N9038A-544	MY54450026	Mar. 28,23	Mar. 27,24
EXA Signal Analyzer	KEYSIGHT	N9010A-544	MY54510355	May.10,23	May.09,24
Loop Antenna	Schwarzbeck	FMZB 1519B	00173	Sep.03,23	Sep.02,24
Bilog Antenna	ETS-LINDGRE N	3143B	00161965	Feb. 18,23	Feb. 17,24
Bilog Antenna	ETS-LINDGRE N	3143B	00161965	Feb. 17,24	Feb. 16,25
Horn Antenna	ETS-LINDGRE N	3117	00168692	Feb. 18,23	Feb. 17,24
Horn Antenna	ETS-LINDGRE N	3117	00168692	Feb. 17,24	Feb. 16,25
Horn Antenna (18GHz-40GHz)	N/A	QWH-SL-18-40-K- SG/QMS-00361	15433	Sep.04, 23	Sep.03, 24
Radio Communication Analyzer	ANRITSU	MT8820C	6201465426	Feb. 14,23	Feb. 13,24
Radio Communication Analyzer	ANRITSU	MT8820C	6201465426	Feb. 13,24	Feb. 12,25
Signal Pre-Amplifier	EMSI	EMC 9135	980249	May. 06,23	May. 05,24
Signal Pre-Amplifier	EMSI	EMC 012645B	980257	May.10,23	May.09,24
Signal Pre-Amplifier	EMSI	EMC 184045B	980259	Feb. 17,23	Feb.16,24
Signal Pre-Amplifier	EMSI	EMC 184045B	980259	Feb.16,24	Feb.15,25
3m Semi-anechoic Chamber	ETS-LINDGRE N	9m*6m*6m	Euroshieldpn- CT0001143-121 6	Nov. 14,23	Nov. 13,26
Test Software	E3	V 9.160323	N/A	N/A	N/A
Test Software	JS1120	3.1.36	N/A	N/A	N/A
10dB Attenuator	JFW/USA	50HF-010-SMA	50HF-010-SMA	May. 06,23	May. 05,24
Power Meter	Anritsu	ML2495A	1506002	Feb. 14,23	Feb. 13,24
Power Meter	Anritsu	ML2495A	1506002	Feb. 13,24	Feb. 12,25
Power Sensor	Anritsu	MA2411B	1339352	Feb. 14,23	Feb. 13,24
Power Sensor	Anritsu	MA2411B	1339352	Feb. 13,24	Feb. 12,25
Temperature Chamber	ESPEC	SH-242	93000855	May. 06,23	May. 05,24
MXG Analog Microwave Signal Generator	KEYSIGHT	N5183A	MY50143024	Feb. 14,23	Feb. 13,24
MXG Analog Microwave Signal Generator	KEYSIGHT	N5183A	MY50143024	Feb. 13,24	Feb. 12,25
Base station R&S CMW500	Rohde&Schwa rz	CMW500	153085	May.10,23	May.09,24
DC Source	Kikusui/JP	PMX18-5A	N/A	Aug. 11,23	Aug. 10,24

- NOTE:**
1. The calibration interval of the above test instruments is 12 or 36 months and the calibrations are traceable to CEPREI/CHINA, GRGT/CHINA and NIM/CHINA.
 2. The test was performed in 3m Semi-anechoic Chamber and RF Oven Room.
 3. The horn antenna is used only for the measurement of emission frequency above 1GHz if tested.
 4. The IC Company Number is 21771; The CAB Identifier No. is CN0007.



2 GENERAL INFORMATION

2.1 GENERAL DESCRIPTION OF EUT

3 PRODUCT	M SoM	
BRAND NAME	Particle	
MODEL NAME	M404	
NOMINAL VOLTAGE	VCC: 3.8V. 3V3:3.3V	
MODULATION TYPE	GPRS: GMSK EDGE: 8PSK LTE Band 2/25: QPSK, 16QAM	
FREQUENCY RANGE	GPRS/EDGE	1850.2MHz ~ 1909.8MHz
	LTE Band 2 Channel Bandwidth: 1.4MHz	1850.7MHz ~ 1909.3MHz
	LTE Band 2 Channel Bandwidth: 3MHz	1851.5MHz ~ 1908.5MHz
	LTE Band 2 Channel Bandwidth: 5MHz	1852.5MHz ~ 1907.5MHz
	LTE Band 2 Channel Bandwidth: 10MHz	1855.0MHz ~ 1905.0MHz
	LTE Band 2 Channel Bandwidth: 15MHz	1857.5MHz ~ 1902.5MHz
	LTE Band 2 Channel Bandwidth: 20MHz	1860.0MHz ~ 1900.0MHz
	LTE Band 25 Channel Bandwidth: 1.4MHz	1850.7MHz ~ 1914.3MHz
	LTE Band 25 Channel Bandwidth: 3MHz	1851.5MHz ~ 1913.5MHz
	LTE Band 25 Channel Bandwidth: 5MHz	1852.5MHz ~ 1912.5MHz
	LTE Band 25 Channel Bandwidth: 10MHz	1855.0MHz ~ 1910.0MHz
	LTE Band 25 Channel Bandwidth: 15MHz	1857.5MHz ~ 1907.5MHz
	LTE Band 25 Channel Bandwidth: 20MHz	1860.0MHz ~ 1905.0MHz



MAX. EIRP POWER	GPRS	1887.99mW
	EDGE	1297.18mW
	LTE Band 2 Channel Bandwidth: 1.4MHz	770.90mW
	LTE Band 2 Channel Bandwidth: 3MHz	743.02mW
	LTE Band 2 Channel Bandwidth: 5MHz	749.89 mW
	LTE Band 2 Channel Bandwidth: 10MHz	760.33mW
	LTE Band 2 Channel Bandwidth: 15MHz	743.02mW
	LTE Band 2 Channel Bandwidth: 20MHz	739.61mW
	LTE Band 25 Channel Bandwidth: 1.4MHz	633.87mW
	LTE Band 25 Channel Bandwidth: 3MHz	629.51mW
	LTE Band 25 Channel Bandwidth: 5MHz	662.22mW
	LTE Band 25 Channel Bandwidth: 10MHz	657.66mW
	LTE Band 25 Channel Bandwidth: 15MHz	662.22mW
	LTE Band 25 Channel Bandwidth: 20MHz	648.63mW
	EMISSION DESIGNATOR	GPRS
EDGE		238KGXW
LTE Band 2 Channel Bandwidth: 1.4MHz		QPSK: 1M11G7D
		16QAM: 1M11W7D
		64QAM: /
LTE Band 2 Channel Bandwidth: 3MHz		QPSK: 1M15G7D
		16QAM: 1M15W7D
		64QAM: /



EMISSION DESIGNATOR	LTE Band 2 Channel Bandwidth: 5MHz	QPSK: 1M23G7D
		16QAM: 1M23W7D
		64QAM: /
	LTE Band 2 Channel Bandwidth: 10MHz	QPSK: 1M58G7D
		16QAM: 1M58W7D
		64QAM: /
	LTE Band 2 Channel Bandwidth: 15MHz	QPSK: 2M58G7D
		16QAM: 2M61G7D
		64QAM: /
	LTE Band 2 Channel Bandwidth: 20MHz	QPSK: 4M12G7D
		16QAM: 4M12W7D
		64QAM: /
LTE Band 25 Channel Bandwidth: 1.4MHz	QPSK: 1M10G7D	
	16QAM: 1M10W7D	
	64QAM: /	
LTE Band 25 Channel Bandwidth: 3MHz	QPSK: 1M14G7D	
	16QAM: 1M14W7D	
	64QAM: /	
LTE Band 25 Channel Bandwidth: 5MHz	QPSK: 1M23G7D	
	16QAM: 1M23W7D	
	64QAM: /	
LTE Band 25 Channel Bandwidth: 10MHz	QPSK: 1M88G7D	
	16QAM: 1M88W7D	
	64QAM: /	
LTE Band 25 Channel Bandwidth: 15MHz	QPSK: 2M82G7D	
	16QAM: 2M85G7D	
	64QAM: /	
LTE Band 25 Channel Bandwidth: 20MHz	QPSK: 4M44G7D	
	16QAM: 4M44W7D	
	64QAM: /	
ANTENNA TYPE	Fixed External Antenna with 5.3dBi gain for GPRS1900/ LTE B2/ LTE B25	
HW VERSION	v0.2	



SW VERSION	v5.5.2
I/O PORTS	Refer to user's manual
CABLE SUPPLIED	N/A
EXTREME TEMPERATURE	-35-75 °C
EXTREME VOLTAGE	VCC: 3.3V. 3V3:3.0V- VCC: 4.3V. 3V3:3.6V

NOTE:

1. For a more detailed features description, please refer to the manufacturer's specifications or the user's manual.
2. The EUT incorporates a SISO function. Physically, the EUT provides one completed transmitter and one receiver.

MODULATION MODE	TX FUNCTION
GPRS/EDGE	1TX/1RX
WCDMA	1TX/1RX
LTE	1TX/1RX

3. For the test results, the EUT had been tested with all conditions. But only the worst case was shown in test report.
4. Antenna gain and EUT conducted cable loss are provided by the customer, and the laboratory will record the results based on these items that involve these two parameters.

DRAFT



3.1 CONFIGURATION OF SYSTEM UNDER TEST

FOR RADIATION EMISSION TEST

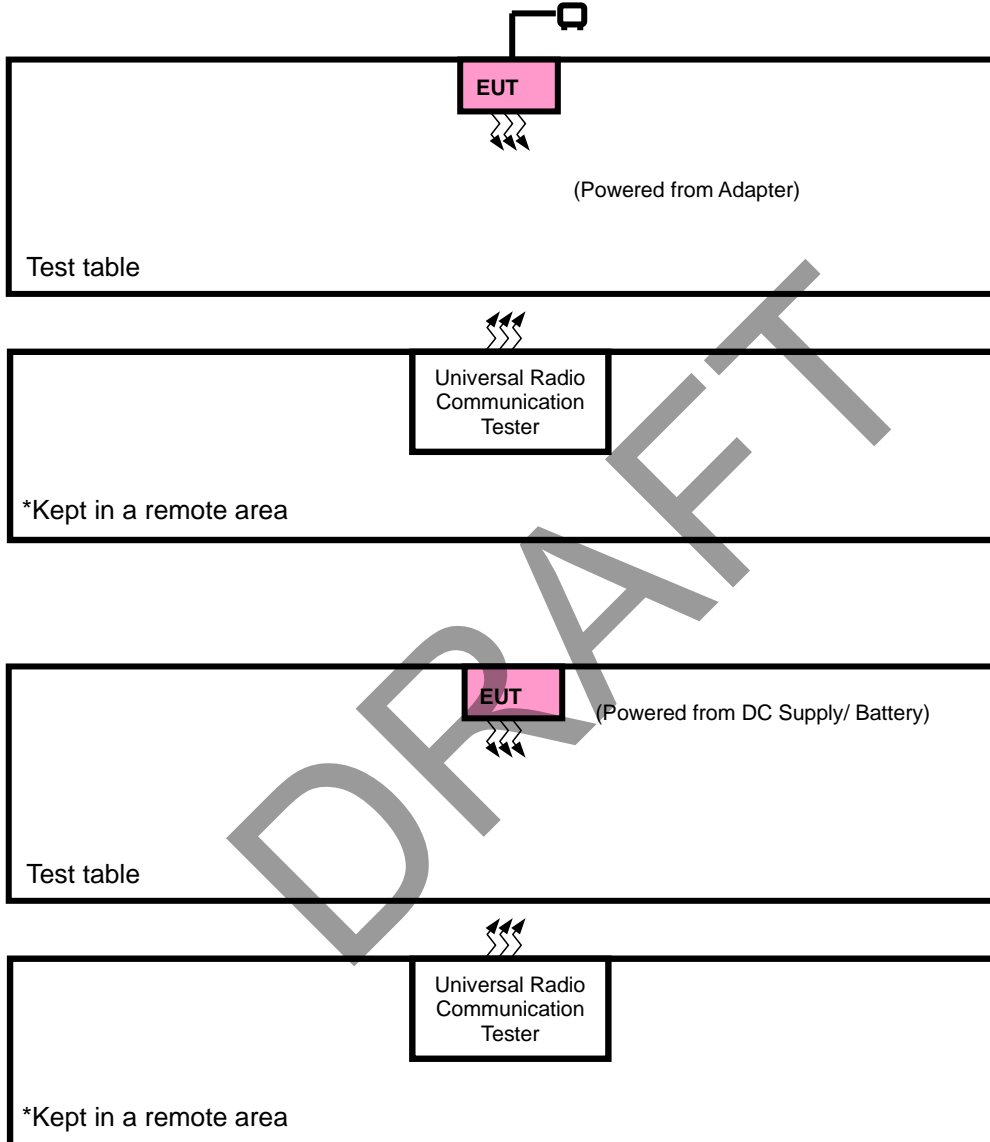



3.2 DESCRIPTION OF SUPPORT UNITS

The EUT has been tested as an independent unit together with other necessary accessories or support units. The following support units or accessories were used to form a representative test configuration during the tests.

NO.	PRODUCT	BRAND	MODEL NO.	SERIAL NO.	FCC ID
1	DC source	Kikusui/JP	PMX18-5A	0000001	N/A

NO.	SIGNAL CABLE DESCRIPTION OF THE ABOVE SUPPORT UNITS
1	DC Line: Unshielded, Detachable 1.0m

3.3 TEST ITEM AND TEST CONFIGURATION

Pre-Scan has been conducted to determine the worst-case mode from all possible combinations between available modulations, data rates, XYZ axis and antenna ports. The worst case in EIRP and radiated emission was found when positioned on X-plane for WCDMA and X-plane for LTE. Following channel(s) was (were) selected for the final test as listed below:

EUT CONFIGURE MODE	DESCRIPTION
A	EUT + Adapter with GPRS or WCDMA or LTE link
B	EUT + DC Supply with GPRS or WCDMA or LTE link



GPRS MODE

EUT CONFIGURE MODE	TEST ITEM	AVAILABLE CHANNEL	TESTED CHANNEL	MODE
A	EIRP	512 to 810	512, 661, 810	GPRS,EDGE
B	FREQUENCY STABILITY	512 to 810	512, 661, 810	GPRS,EDGE
A	OCCUPIED BANDWIDTH	512 to 810	512, 661, 810	GPRS,EDGE
A	PEAK TO AVERAGE RATIO	512 to 810	512, 661, 810	GPRS,EDGE
A	BAND EDGE	512 to 810	512, 810	GPRS,EDGE
A	CONDUCTED EMISSION	512 to 810	512, 661, 810	GPRS,EDGE
A	RADIATED EMISSION	512 to 810	512, 661, 810	GPRS,EDGE

WCDMA MODE

EUT CONFIGURE MODE	TEST ITEM	AVAILABLE CHANNEL	TESTED CHANNEL	MODE
A	EIRP	9262 to 9538	9262, 9400, 9538	WCDMA
B	FREQUENCY STABILITY	9262 to 9538	9262, 9400, 9538	WCDMA
A	OCCUPIED BANDWIDTH	9262 to 9538	9262, 9400, 9538	WCDMA
A	PEAK TO AVERAGE RATIO	9262 to 9538	9262, 9400, 9538	WCDMA
A	BAND EDGE	9262 to 9538	9262, 9538	WCDMA
A	CONDUCTED EMISSION	9262 to 9538	9262, 9400, 9538	WCDMA
A	RADIATED EMISSION	9262 to 9538	9262, 9400, 9538	WCDMA



LTE BAND 2 MODE

EUT CONFIGURE MODE	TEST ITEM	AVAILABLE CHANNEL	TESTED CHANNEL	CHANNEL BANDWIDTH	MODULATION	MODE
B	EIRP	18607 to 19193	18607, 18900, 19193	1.4MHz	QPSK, 16QAM	1 RB / 0 RB Offset
		18615 to 19185	18615, 18900, 19185	3MHz	QPSK, 16QAM	1 RB / 0 RB Offset
		18625 to 19175	18625, 18900, 19175	5MHz	QPSK, 16QAM	1 RB / 0 RB Offset
		18650 to 19150	18650, 18900, 19150	10MHz	QPSK, 16QAM	1 RB / 0 RB Offset
		18675 to 19125	18675, 18900, 19125	15MHz	QPSK, 16QAM	1 RB / 0 RB Offset
		18700 to 19100	18700, 18900, 19100	20MHz	QPSK, 16QAM	1 RB / 0 RB Offset
B	FREQUENCY STABILITY	18607 to 19193	18607, 19193	1.4MHz	QPSK	1 RB / 0 RB Offset
		18615 to 19185	18615, 19185	3MHz	QPSK	1 RB / 0 RB Offset
		18625 to 19175	18625, 19175	5MHz	QPSK	1 RB / 0 RB Offset
		18650 to 19150	18650, 19150	10MHz	QPSK	1 RB / 0 RB Offset
		18675 to 19125	18675, 19125	15MHz	QPSK	1 RB / 0 RB Offset
		18700 to 19100	18700, 19100	20MHz	QPSK	1 RB / 0 RB Offset
B	OCCUPIED BANDWIDTH	18607 to 19193	18607, 18900, 19193	1.4MHz	QPSK, 16QAM	6 RB / 0 RB Offset
		18615 to 19185	18615, 18900, 19185	3MHz	QPSK, 16QAM	15 RB / 0 RB Offset
		18625 to 19175	18625, 18900, 19175	5MHz	QPSK, 16QAM	25 RB / 0 RB Offset
		18650 to 19150	18650, 18900, 19150	10MHz	QPSK, 16QAM	50 RB / 0 RB Offset
		18675 to 19125	18675, 18900, 19125	15MHz	QPSK, 16QAM	75 RB / 0 RB Offset
		18700 to 19100	18700, 18900, 19100	20MHz	QPSK, 16QAM	100 RB / 0 RB Offset
B	PEAK TO AVERAGE RATIO	18607 to 19193	18607, 18900, 19193	1.4MHz	QPSK, 16QAM	1 RB / 0 RB Offset
		18615 to 19185	18615, 18900, 19185	3MHz	QPSK, 16QAM	1 RB / 0 RB Offset
		18625 to 19175	18625, 18900, 19175	5MHz	QPSK, 16QAM	1 RB / 0 RB Offset
		18650 to 19150	18650, 18900, 19150	10MHz	QPSK, 16QAM	1 RB / 0 RB Offset
		18675 to 19125	18675, 18900, 19125	15MHz	QPSK, 16QAM	1 RB / 0 RB Offset
		18700 to 19100	18700, 18900, 19100	20MHz	QPSK, 16QAM	1 RB / 0 RB Offset



B	BAND EDGE	18607 to 19193	18607	1.4MHz	QPSK	1 RB / 0 RB Offset
			19193	1.4MHz	QPSK	6 RB / 0 RB Offset
		18615 to 19185	18615	3MHz	QPSK	1 RB / 5 RB Offset
			19185	3MHz	QPSK	6 RB / 0 RB Offset
		18625 to 19175	18625	5MHz	QPSK	1 RB / 0 RB Offset
			19175	5MHz	QPSK	15 RB / 0 RB Offset
		18650 to 19150	18650	10MHz	QPSK	1 RB / 14 RB Offset
			19150	10MHz	QPSK	15 RB / 0 RB Offset
		18675 to 19125	18675	15MHz	QPSK	1 RB / 0 RB Offset
			19125	15MHz	QPSK	25 RB / 0 RB Offset
		18700 to 19100	18700	20MHz	QPSK	1 RB / 24 RB Offset
			19100	20MHz	QPSK	25 RB / 0 RB Offset
		18607 to 19193	18607, 18900, 19193	1.4MHz	QPSK	1 RB / 0 RB Offset
			18615 to 19185	18615, 18900, 19185	3MHz	QPSK
		18625 to 19175	18625, 18900, 19175	5MHz	QPSK	1 RB / 49 RB Offset
			18650 to 19150	18650, 18900, 19150	10MHz	QPSK
18675 to 19125	18675, 18900, 19125	15MHz	QPSK	1 RB / 0 RB Offset		
	18700 to 19100	18700, 18900, 19100	20MHz	QPSK	75 RB / 0 RB Offset	
18607 to 19193	18607, 18900, 19193	1.4MHz	QPSK	1 RB / 0 RB Offset		
	18615 to 19185	18615, 18900, 19185	3MHz	QPSK	1 RB / 0 RB Offset	
18625 to 19175	18625, 18900, 19175	5MHz	QPSK	1 RB / 0 RB Offset		
	18650 to 19150	18650, 18900, 19150	10MHz	QPSK	1 RB / 0 RB Offset	
18675 to 19125	18675, 18900, 19125	15MHz	QPSK	1 RB / 0 RB Offset		
	18700 to 19100	18700, 18900, 19100	20MHz	QPSK	1 RB / 0 RB Offset	

Note: 1.This device was tested under all bandwidths, RB configurations and modulations. The worst case was found in QPSK modulation.

2. LTE Band 2 are covered by LTE Band 25, Because it is a subset of LTE Band 25 with the same output power and supported bandwidths, So RSE test data please refer to LTE Band 25



LTE BAND 25 MODE

EUT CONFIGURE MODE	TEST ITEM	AVAILABLE CHANNEL	TESTED CHANNEL	CHANNEL BANDWIDTH	MODULATION	MODE
A	EIRP	26047 to 26683	26047, 26365, 26683	1.4MHz	QPSK, 16QAM	1 RB / 0 RB Offset
		26055 to 26675	26055, 26365, 26675	3MHz	QPSK, 16QAM	1 RB / 0 RB Offset
		26065 to 26665	26065, 26365, 26665	5MHz	QPSK, 16QAM	1 RB / 0 RB Offset
		26090 to 26640	26090, 26365, 26640	10MHz	QPSK, 16QAM	1 RB / 0 RB Offset
		26115 to 26615	26115, 26365, 26615	15MHz	QPSK, 16QAM	1 RB / 0 RB Offset
		26140 to 26590	26140, 26365, 26590	20MHz	QPSK, 16QAM	1 RB / 0 RB Offset
B	FREQUENCY STABILITY	26090 to 26640	26090, 26365, 26640	10MHz	QPSK, 16QAM	50 RB / 0 RB Offset
A	OCCUPIED BANDWIDTH	26047 to 26683	26047, 26365, 26683	1.4MHz	QPSK, 16QAM	6 RB / 0 RB Offset
		26055 to 26675	26055, 26365, 26675	3MHz	QPSK, 16QAM	15 RB / 0 RB Offset
		26065 to 26665	26065, 26365, 26665	5MHz	QPSK, 16QAM	25 RB / 0 RB Offset
		26090 to 26640	26090, 26365, 26640	10MHz	QPSK, 16QAM	50 RB / 0 RB Offset
		26115 to 26615	26115, 26365, 26615	15MHz	QPSK, 16QAM	75 RB / 0 RB Offset
		26140 to 26590	26140, 26365, 26590	20MHz	QPSK, 16QAM	100 RB / 0 RB Offset
A	PEAK TO AVERAGE RATIO	26140 to 26590	26140, 26365, 26590	20MHz	QPSK, 16QAM	1 RB / 0 RB Offset 100 RB / 0 RB Offset

DRAFT



A	BAND EDGE	26047 to 26683	26047	1.4MHz	QPSK, 16QAM	1 RB / 0 RB Offset		
			26683	1.4MHz	QPSK, 16QAM	6 RB / 0 RB Offset		
		26055 to 26675	26055	3MHz	QPSK, 16QAM	1 RB / 5 RB Offset		
			26675	3MHz	QPSK, 16QAM	6 RB / 0 RB Offset		
		26065 to 26665	26065	5MHz	QPSK, 16QAM	1 RB / 0 RB Offset		
			26665	5MHz	QPSK, 16QAM	15 RB / 0 RB Offset		
		26090 to 26640	26090	10MHz	QPSK, 16QAM	1 RB / 14 RB Offset		
			26640	10MHz	QPSK, 16QAM	15 RB / 0 RB Offset		
		26115 to 26615	26115	15MHz	QPSK, 16QAM	1 RB / 0 RB Offset		
			26615	15MHz	QPSK, 16QAM	25 RB / 0 RB Offset		
		26140 to 26590	26140	20MHz	QPSK, 16QAM	1 RB / 24 RB Offset		
			26590	20MHz	QPSK, 16QAM	25 RB / 0 RB Offset		
		A	CONDUCTED EMISSION	26047 to 26683	26047, 26365, 26683	1.4MHz	QPSK, 16QAM	1 RB / 0 RB Offset
				26055 to 26675	26055, 26365, 26675	3MHz	QPSK, 16QAM	1 RB / 0 RB Offset
				26065 to 26665	26065, 26365, 26665	5MHz	QPSK, 16QAM	1 RB / 0 RB Offset
				26090 to 26640	26090, 26365, 26640	10MHz	QPSK, 16QAM	1 RB / 0 RB Offset
26115 to 26615	26115, 26365, 26615			15MHz	QPSK, 16QAM	1 RB / 0 RB Offset		
26140 to 26590	26140, 26365, 26590			20MHz	QPSK, 16QAM	1 RB / 0 RB Offset		
A	RADIATED EMISSION	26047 to 26683	26365	1.4MHz	QPSK	1 RB / 0 RB Offset		
		26055 to 26675	26365	3MHz	QPSK	1 RB / 0 RB Offset		
		26065 to 26665	26365	5MHz	QPSK	1 RB / 0 RB Offset		
		26090 to 26640	26090, 26365, 26640	10MHz	QPSK	1 RB / 0 RB Offset		
		26115 to 26615	26365	15MHz	QPSK	1 RB / 0 RB Offset		
		26140 to 26590	26365	20MHz	QPSK	1 RB / 0 RB Offset		

Note: This device was tested under all bandwidths, RB configurations and modulations. The worst case was found in QPSK modulation.



TEST CONDITION:

TEST ITEM	ENVIRONMENTAL CONDITIONS	INPUT POWER	TESTED BY
EIRP	25deg. C, 57%RH	AC 120V/60Hz	Jace Hu
FREQUENCY STABILITY	23deg. C, 61%RH	DC 3.3V/3.8V/4.3V	James Fu
OCCUPIED BANDWIDTH	23deg. C, 61%RH	AC 120V/60Hz	James Fu
PEAK TO AVERAGE RATIO	23deg. C, 61%RH	AC 120V/60Hz	James Fu
BAND EDGE	23deg. C, 61%RH	AC 120V/60Hz	James Fu
CONDUCTED EMISSION	23deg. C, 61%RH	AC 120V/60Hz	James Fu
RADIATED EMISSION	23deg. C, 70%RH	AC 120V/60Hz	Jace Hu

DRAFT



3.4 EUT OPERATING CONDITIONS

The EUT makes a call to the communication simulator. The communication simulator station system controlled a EUT to export maximum output power under transmission mode and specific channel frequency

3.5 GENERAL DESCRIPTION OF APPLIED STANDARDS

The EUT is a RF product. According to the specifications of the manufacturer, it must comply with the requirements of the following standards:

Canada RSS-133, Issue 6, Amendment 1, January 2018

Canada RSS-Gen, Issue 5, Amendment 1, March 2019

ANSI C63.26 - 2015

NOTE: All test items have been performed and recorded as per the above standards.

2.7 TRANSMIT ANTENNA

The applicant for equipment certification shall provide a list of all antenna types that may be used with the transmitter, where applicable (i.e. for transmitters with detachable antenna), indicating the maximum permissible antenna gain (in dBi) and the required impedance for each antenna. The test report shall demonstrate the compliance of the transmitter with the limit for maximum equivalent isotropically radiated power (e.i.r.p.) specified in the applicable RSS, when the transmitter is equipped with any antenna type, selected from this list.

Antenna Type	Fixed External Antenna
Antenna Gain	5.3dBi gain for GPRS1900/LTE B2/ LTE B25
Impedance	50 Ω



4 TEST TYPES AND RESULTS

4.1 OUTPUT POWER MEASUREMENT

4.1.1 LIMITS OF OUTPUT POWER MEASUREMENT

Mobile and portable stations are limited to 2 watts EIRP.

4.1.2 TEST PROCEDURES

EIRP MEASUREMENT:

Per KDB 971168 D01 Power Meas License Digital Systems v03r01 or subclause 5.2.5.5 of ANSI C63.26-2015, the relevant equation for determining the ERP or EIRP from the conducted RF output power measured using the guidance provided above is:

$$\text{ERP or EIRP} = P_{\text{Meas}} + G_{\text{T}} - L_{\text{c}}$$

Where:

ERP or EIRP = effective radiated power or equivalent isotropically radiated power, respectively

(expressed in the same units as P_{Meas} , typically dBW or dBm);

P_{Meas} = measured transmitter output power or PSD, in dBm or dBW;

G_{T} = gain of the transmitting antenna, in dBd (ERP) or dBi (EIRP);

L_{c} = signal attenuation in the connecting cable between the transmitter and antenna, in dB.

$$\text{ERP} = \text{EIRP} - 2.15$$

CONDUCTED POWER MEASUREMENT:

The EUT was set up for the maximum power with WCDMA & LTE link data modulation and link up with simulator. Set the EUT to transmit under low, middle and high channel and record the power level shown on simulator.



4.1.3 TEST SETUP

CONDUCTED POWER MEASUREMENT:



4.1.4 TEST RESULTS

CONDUCTED OUTPUT POWER (dBm)

Please Refer to Appendix Of this test report

DRAFT



4.2 FREQUENCY STABILITY MEASUREMENT

4.2.1 LIMITS OF FREQUENCY STABILITY MEASUREMENT

The frequency stability shall be sufficient to ensure that the fundamental emission stays within the authorized frequency block.

4.2.2 TEST PROCEDURE

- a. Device is placed at the oven room. The oven room could control the temperatures and humidity. Power warm up is at least 15 min and power applied should perform before recording frequency error.
- b. EUT is connected the external power supply to control the DC input power. The test voltage range is from minimum to maximum working voltage. Each step shall be record the frequency error rate.
- c. The temperature range step is 10 degrees in this test items. All temperature levels shall be hold the $\pm 0.5^{\circ}\text{C}$ during the measurement testing. The each temperature step shall be at least 0.5 hours, consider the EUT could be test under the stability condition.

NOTE: The frequency error was recorded frequency error from the communication simulator.

4.2.3 TEST SETUP

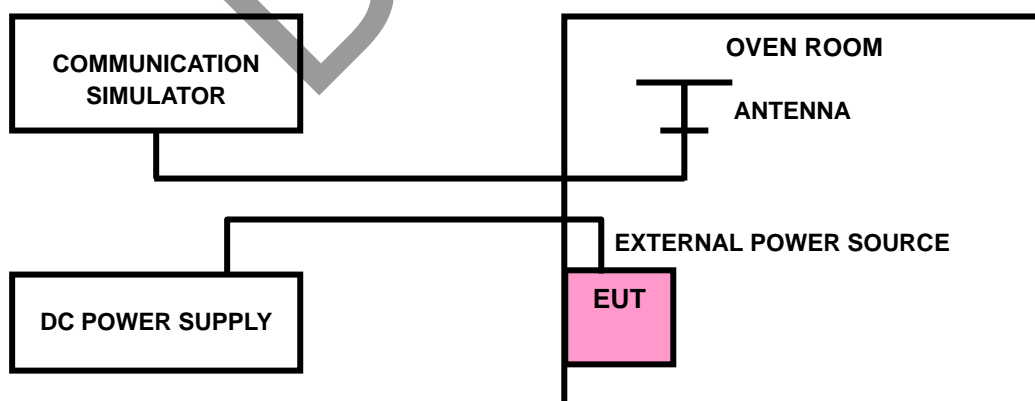



**BUREAU
VERITAS**

Test Report No.: W7L-P23120015R102

4.2.4 TEST RESULTS

Please Refer to Appendix Of this test report.

- Note: 1.VL = Low voltage(3.3V); VN/NV = Normal voltage(3.8V); VH = High voltage(4.3V);
NT = Normal temperature (25°C)
2. The frequency fundamental emissions stay within the authorized frequency block.

DRAFT



4.3 OCCUPIED BANDWIDTH MEASUREMENT

4.3.1 TEST PROCEDURES

The EUT makes a call to the communication simulator. All measurements were done at low, middle and high operational frequency range. The communication simulator station system controlled a EUT to export maximum output power under transmission mode and specific channel frequency. Use OBW measurement function of Spectrum analyzer to measure 99 % occupied bandwidth.

4.3.2 TEST SETUP

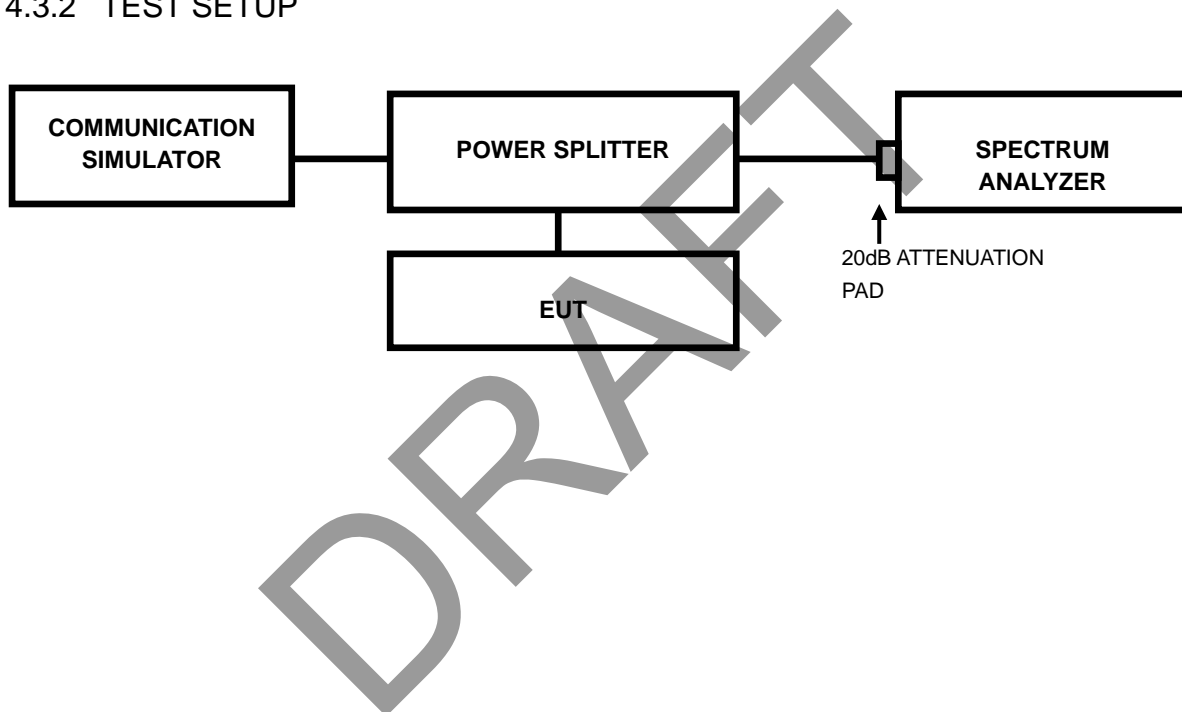



Test Report No.: W7L-P23120015R102

4.3.3 TEST RESULTS

Please Refer to Appendix Of this test report.

DRAFT



4.4 BAND EDGE MEASUREMENT

4.4.1 LIMITS OF BAND EDGE MEASUREMENT

Power of any emission outside of the authorized operating frequency ranges must be attenuated below the transmitting power (P) by a factor of at least $43 + 10 \log(P)$ dB. In the 1 MHz bands immediately outside and adjacent to the frequency block a resolution bandwidth of at least one percent of the emission bandwidth of the fundamental emission of the transmitter may be employed.

4.4.2 TEST SETUP

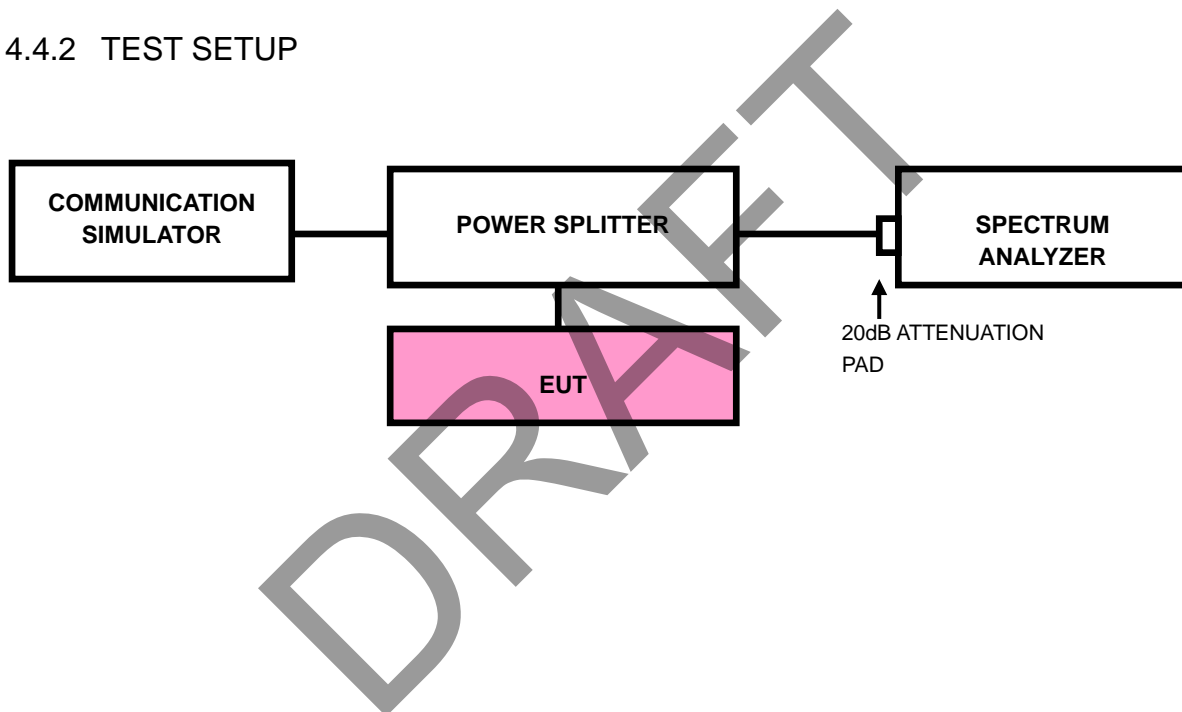



4.4.3 TEST PROCEDURES

- a) All measurements were done at low and high operational frequency range
- b) Connect the transmitter to the spectrum analyzer via coaxial cable while ensuring proper impedance matching.
- c) Tune the analyzer to the nominal center frequency of the emission bandwidth (EBW)
- d) .Set the resolution bandwidth (RBW) $\geq 1\%$ EBW in the 1MHz band immediately outside and adjacent to the band edge.
- e) Beyond the 1MHz band from the band edge, RBW=1MHz was used.
- f) Set the video bandwidth (VBW) to $\geq 3 \times$ RBW.
- g) Select the average power (RMS) display detector.
- h) Set the number of measurement points to ≥ 1001 .
- i) Use auto-coupled sweep time.
- j) Perform the measurement over an interval of time when the transmission is continuous and at its maximum power level.
- k) The RF fundamental frequency should be excluded against the limit line in the operating frequency band and use RBW is 10KHz or 100KHz.
- l) Record the max trace plot into the test report.



Test Report No.: W7L-P23120015R102

4.4.4 TEST RESULTS

Please Refer to Appendix Of this test report.

DRAFT



4.5 CONDUCTED SPURIOUS EMISSIONS

4.5.1 LIMITS OF CONDUCTED SPURIOUS EMISSIONS MEASUREMENT

The power of any emission outside of the authorized operating frequency ranges must be attenuated below the transmitting power (P) by a factor of at least $43 + 10 \log(P)$ dB. The emission limit equal to -13dBm .

4.5.2 TEST PROCEDURE

- a. The EUT makes a phone call to the communication simulator. All measurements were done at low, middle and high operational frequency range.
- b. Measuring frequency range is from 9 kHz up to a frequency including its 10th harmonic. 10dB attenuation pad is connected with spectrum. RBW=1MHz and VBW=3MHz is used for conducted emission measurement.

4.5.3 TEST SETUP

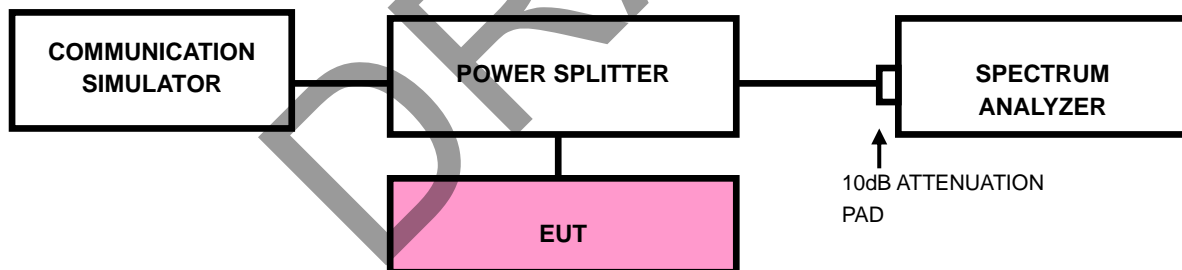



Test Report No.: W7L-P23120015R102

4.5.4 TEST RESULTS

NOTE : The 9K~30MHz amplitude of spurious emissions attenuated more than 20 dB below the permissible value is not required in the report.

Please Refer to Appendix Of this test report.

DRAFT



4.6 RADIATED EMISSION MEASUREMENT

4.6.1 LIMITS OF RADIATED EMISSION MEASUREMENT

The power of any emission outside of the authorized operating frequency ranges must be attenuated below the transmitting power (P) by a factor of at least $43 + 10 \log(P)$ dB. The emission limit equal to -13dBm .

4.6.2 TEST PROCEDURES

- a. Substitution method is used for E.I.R.P measurement. In the semi-anechoic chamber, EUT placed on the 0.8m/1.5m height of Turn Table, rotated the table around 360 degrees to search the maximum radiation power and receiver antenna shall be rotated vertical and horizontal polarization and moved height from 1m to 4m to find the maximum polar radiated power. The "Read Value" is the spectrum reading the maximum power value.
- b. The substitution horn antenna is substituted for EUT at the same position and signals generator export the CW signal to the substitution antenna via a TX cable. Rotated the Turn Table and moved receiving antenna to find the maximum radiation power. Adjust output power level of S.G to get a Value of spectrum reading equal to "Read Value " of step a. Record the power level of S.G
- c. $\text{EIRP} = \text{Output power level of S.G} - \text{TX cable loss} + \text{Antenna gain of substitution horn}$.

NOTE: The resolution bandwidth and video bandwidth of test receiver/spectrum analyzer is 1MHz/3MHz.

4.6.3 DEVIATION FROM TEST STANDARD

No deviation



4.6.4 TEST SETUP

< Frequency Range below 30MHz >

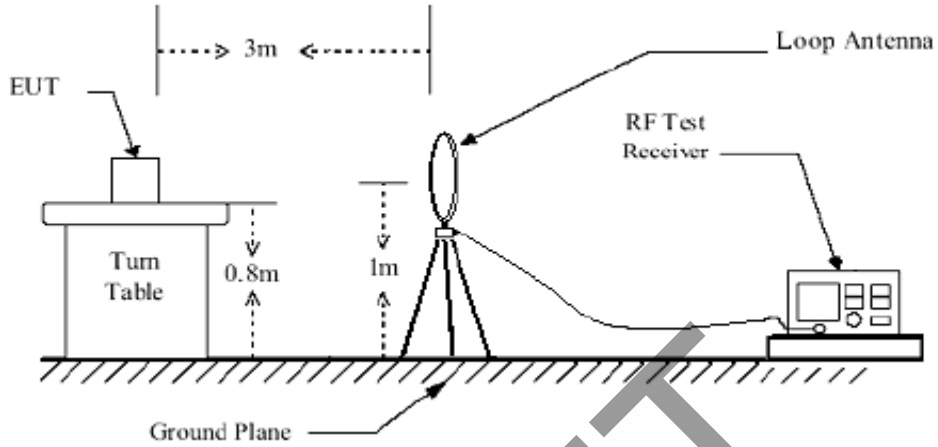

< Frequency Range 30MHz~1GHz >

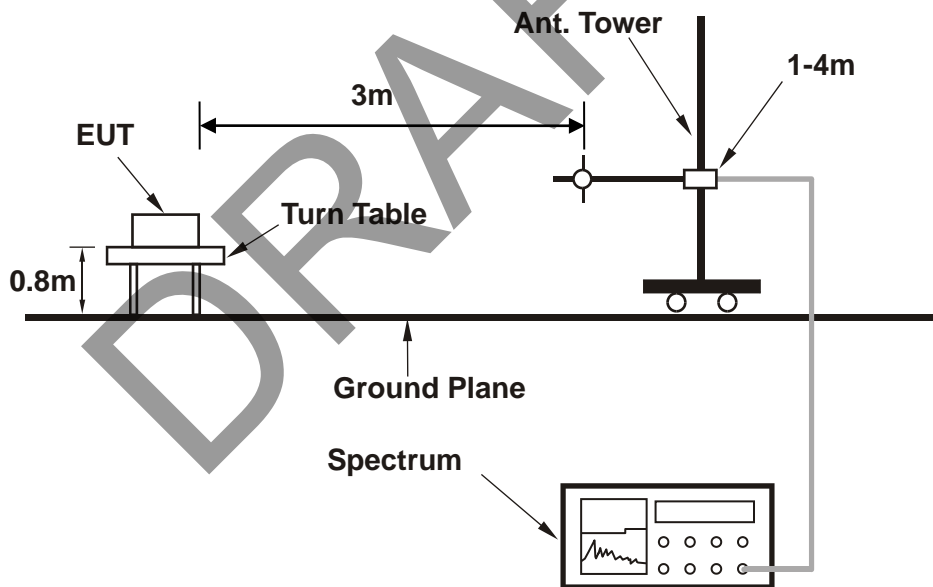



< Frequency Range above 1GHz >

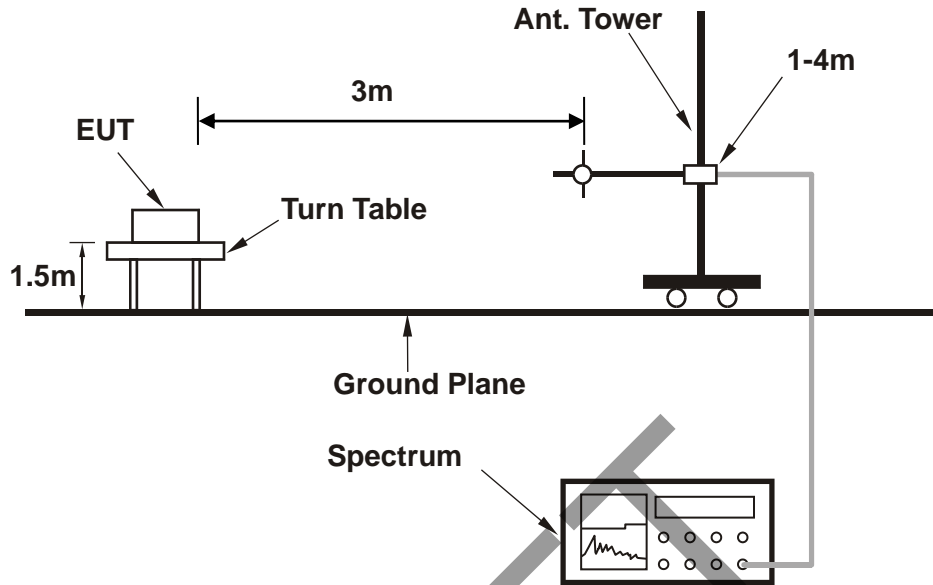

For the actual test configuration, please refer to the attached file (Test Setup Photo).

DRAFT



4.6.5 TEST RESULTS

NOTE : The 9K~30MHz amplitude of spurious emissions attenuated more than 20 dB below the permissible value is not required in the report.

BELOW 1GHz WORST-CASE DATA

30 MHz – 1GHz data:

LTE Band 25:

CHANNEL BANDWIDTH: 10MHz / QPSK

MODE	TX channel 26365	FREQUENCY RANGE	Below 1000MHz
ENVIRONMENTAL CONDITIONS	23deg. C, 70%RH	INPUT POWER	AC 120V/60HZ
TESTED BY	Jace Hu		
ANTENNA POLARITY & TEST DISTANCE: HORIZONTAL AT 3 M			

	Freq	Level	Read Level	Limit Line	Over Limit	Factor	Remark	Pol/Phase
	MHz	dBm/m	dBm	dBm/m	dB	dB/m		
1	62.980	-62.78	-50.40	-13.00	-49.78	-12.38	Peak	Horizontal
2	109.540	-61.38	-47.10	-13.00	-48.38	-14.28	Peak	Horizontal
3	248.250	-61.07	-49.73	-13.00	-48.07	-11.34	Peak	Horizontal
4	314.210	-56.67	-48.14	-13.00	-43.67	-8.53	Peak	Horizontal
5	439.340	-67.85	-61.68	-13.00	-54.85	-6.17	Peak	Horizontal
6 PP	694.450	-55.40	-58.98	-13.00	-42.40	3.58	Peak	Horizontal

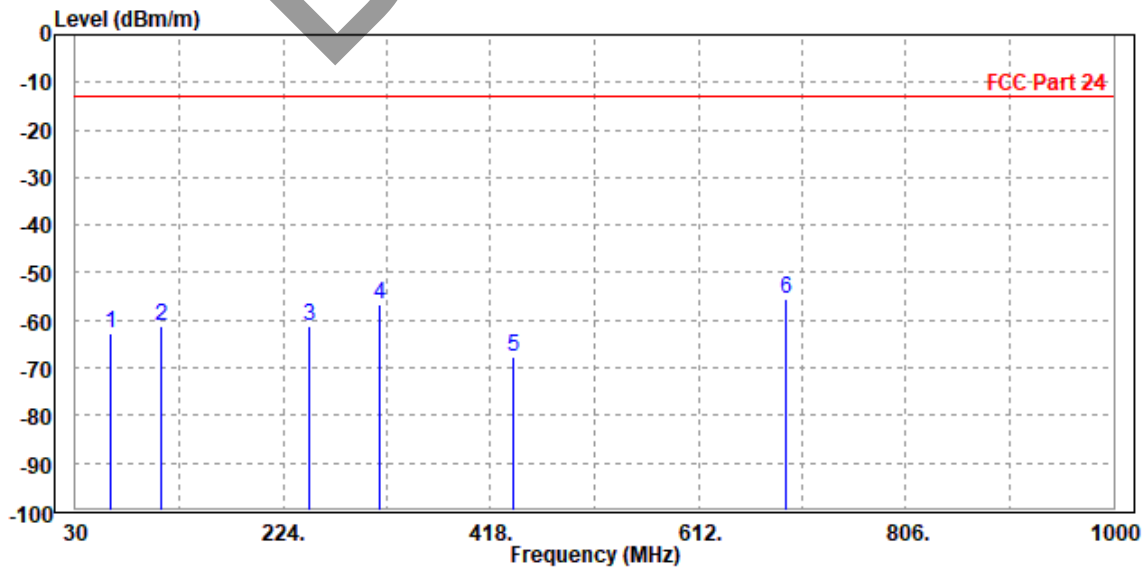



**BUREAU
VERITAS**

Test Report No.: W7L-P23120015R102

MODE	TX channel 26365	FREQUENCY RANGE	Below 1000MHz
ENVIRONMENTAL CONDITIONS	23deg. C, 70%RH	INPUT POWER	AC 120V/60HZ
TESTED BY	Jace Hu		
ANTENNA POLARITY & TEST DISTANCE: VERTICAL AT 3 M			

	Freq	Level	Read Level	Limit Line	Over Limit	Factor	Remark	Pol/Phase
	MHz	dBm/m	dBm	dBm/m	dB	dB/m		
1	PP	62.980	-55.46	-36.52	-13.00	-42.46	-18.94 Peak	Vertical
2		119.240	-60.89	-44.68	-13.00	-47.89	-16.21 Peak	Vertical
3		167.740	-60.55	-49.67	-13.00	-47.55	-10.88 Peak	Vertical
4		255.040	-60.60	-56.89	-13.00	-47.60	-3.71 Peak	Vertical
5		347.190	-60.85	-57.09	-13.00	-47.85	-3.76 Peak	Vertical
6		452.920	-61.17	-56.44	-13.00	-48.17	-4.73 Peak	Vertical

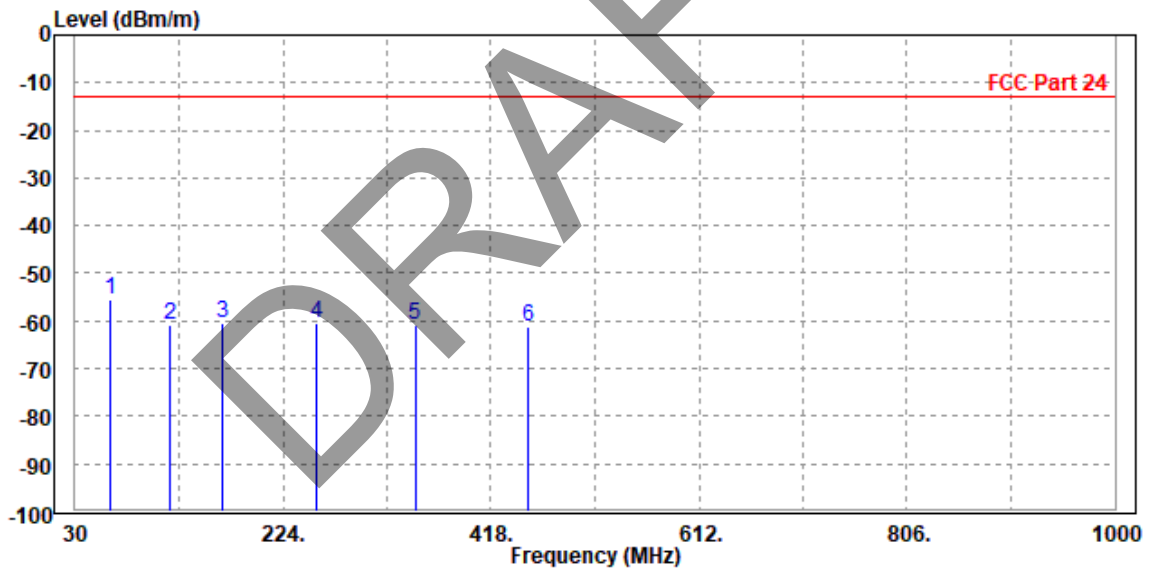



ABOVE 1GHz DATA

Note: For higher frequency, the emission is too low to be detected.

WORST-CASE DATA

GPRS 1900:

CH 512

MODE	TX channel 512	FREQUENCY RANGE	Above 1000MHz
ENVIRONMENTAL CONDITIONS	23deg. C, 70%RH	INPUT POWER	AC 120V/60HZ
TESTED BY	Jace Hu		
ANTENNA POLARITY & TEST DISTANCE: HORIZONTAL AT 3 M			

	Freq	Level	Read Level	Limit Line	Over Limit	Factor	Remark	Pol/Phase
	MHz	dBm/m	dBm	dBm/m	dB	dB/m		
1 PP	3698.000	-48.07	-56.47	-13.00	-35.07	8.40	Peak	Horizontal
2	5550.600	-49.10	-60.90	-13.00	-36.10	11.80	Peak	Horizontal

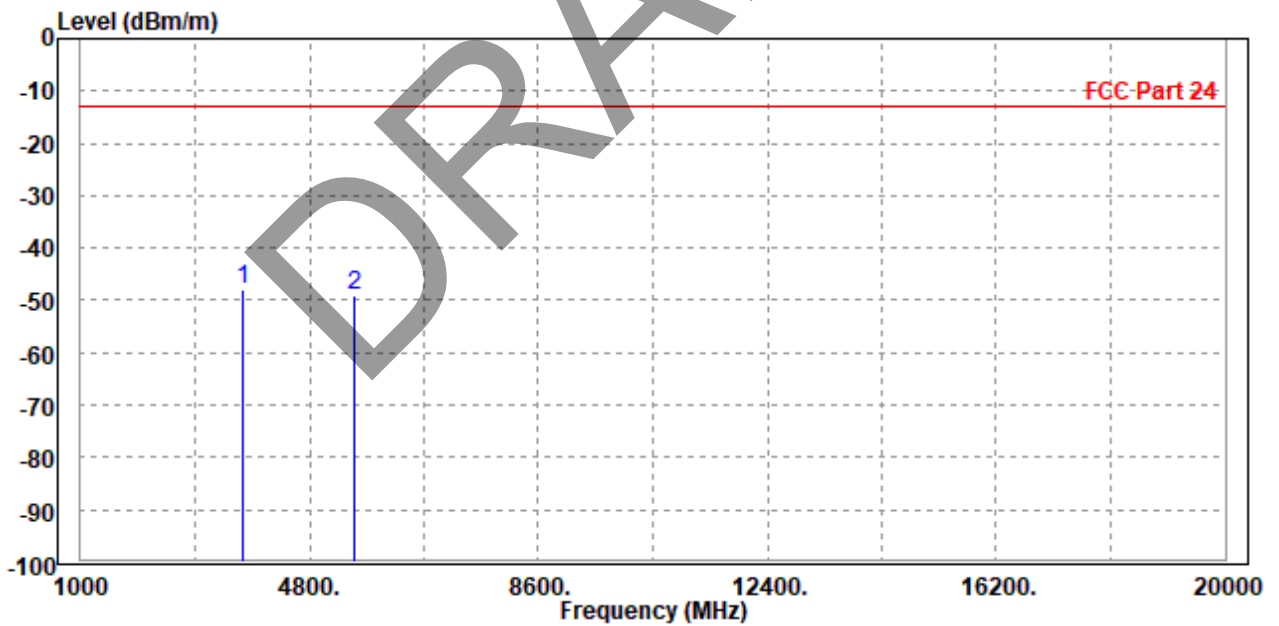



**BUREAU
VERITAS**

Test Report No.: W7L-P23120015R102

MODE	TX channel 512	FREQUENCY RANGE	Above 1000MHz
ENVIRONMENTAL CONDITIONS	23deg. C, 70%RH	INPUT POWER	AC 120V/60HZ
TESTED BY	Jace Hu		
ANTENNA POLARITY & TEST DISTANCE: VERTICAL AT 3 M			

	Read	Limit	Over				
Freq	Level	Level	Line	Limit	Factor	Remark	Pol/Phase
MHz	dBm/m	dBm	dBm/m	dB	dB/m		
1 PP 3700.400	-44.89	-53.52	-13.00	-31.89	8.63	Peak	Vertical
2 5560.000	-47.97	-60.30	-13.00	-34.97	12.33	Peak	Vertical

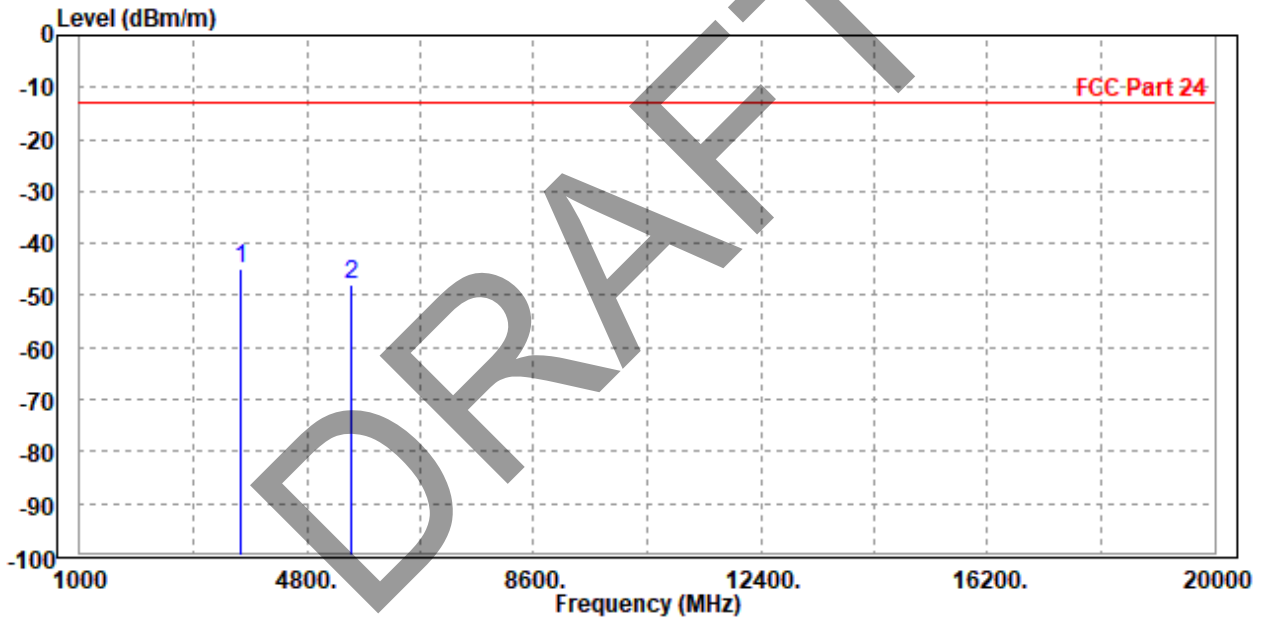



CH 661

MODE	TX channel 661	FREQUENCY RANGE	Above 1000MHz
ENVIRONMENTAL CONDITIONS	23deg. C, 70%RH	INPUT POWER	AC 120V/60HZ
TESTED BY	Jace Hu		
ANTENNA POLARITY & TEST DISTANCE: HORIZONTAL AT 3 M			

	Freq	Level	Read Level	Limit Line	Over Limit	Factor	Remark	Pol/Phase
	MHz	dBm/m	dBm	dBm/m	dB	dB/m		
1	PP 3755.000	-49.39	-57.75	-13.00	-36.39	8.36	Peak	Horizontal
2	5640.000	-49.68	-61.49	-13.00	-36.68	11.81	Peak	Horizontal

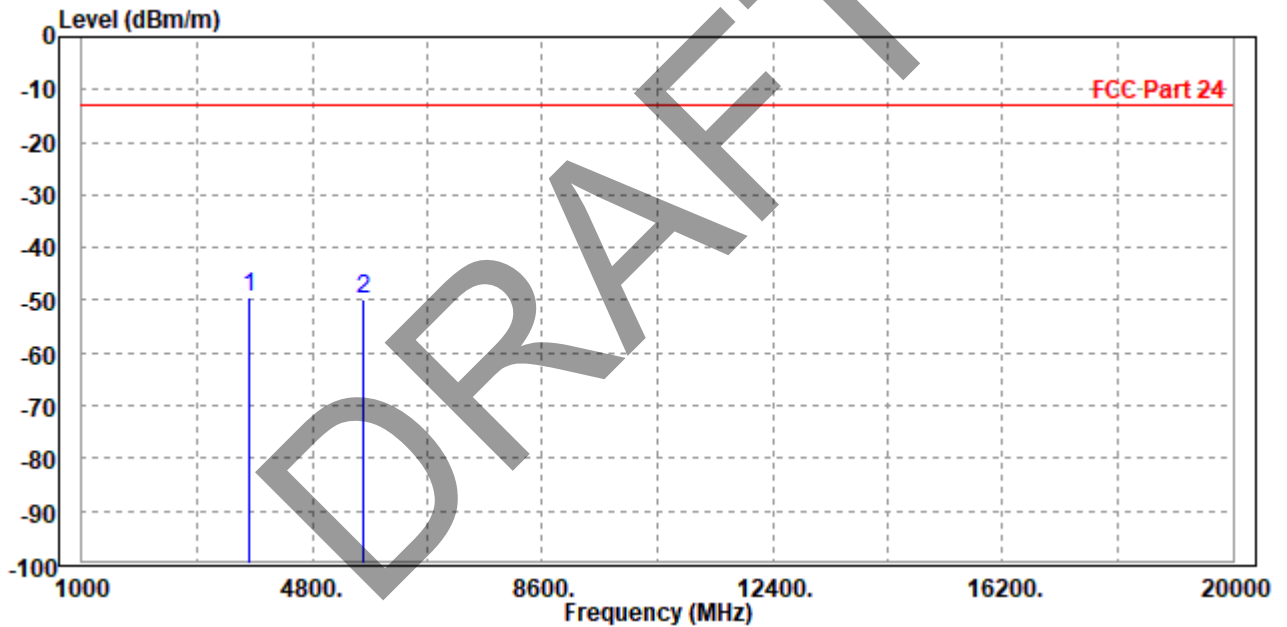



MODE	TX channel 661	FREQUENCY RANGE	Above 1000MHz
ENVIRONMENTAL CONDITIONS	23deg. C, 70%RH	INPUT POWER	AC 120V/60HZ
TESTED BY	Jace Hu		
ANTENNA POLARITY & TEST DISTANCE: VERTICAL AT 3 M			

	Read	Limit	Over				
Freq	Level	Level	Line	Limit	Factor	Remark	Pol/Phase
MHz	dBm/m	dBm	dBm/m	dB	dB/m		
1 PP 3760.000	-44.66	-53.29	-13.00	-31.66	8.63	Peak	Vertical
2 5636.000	-49.68	-62.00	-13.00	-36.68	12.32	Peak	Vertical

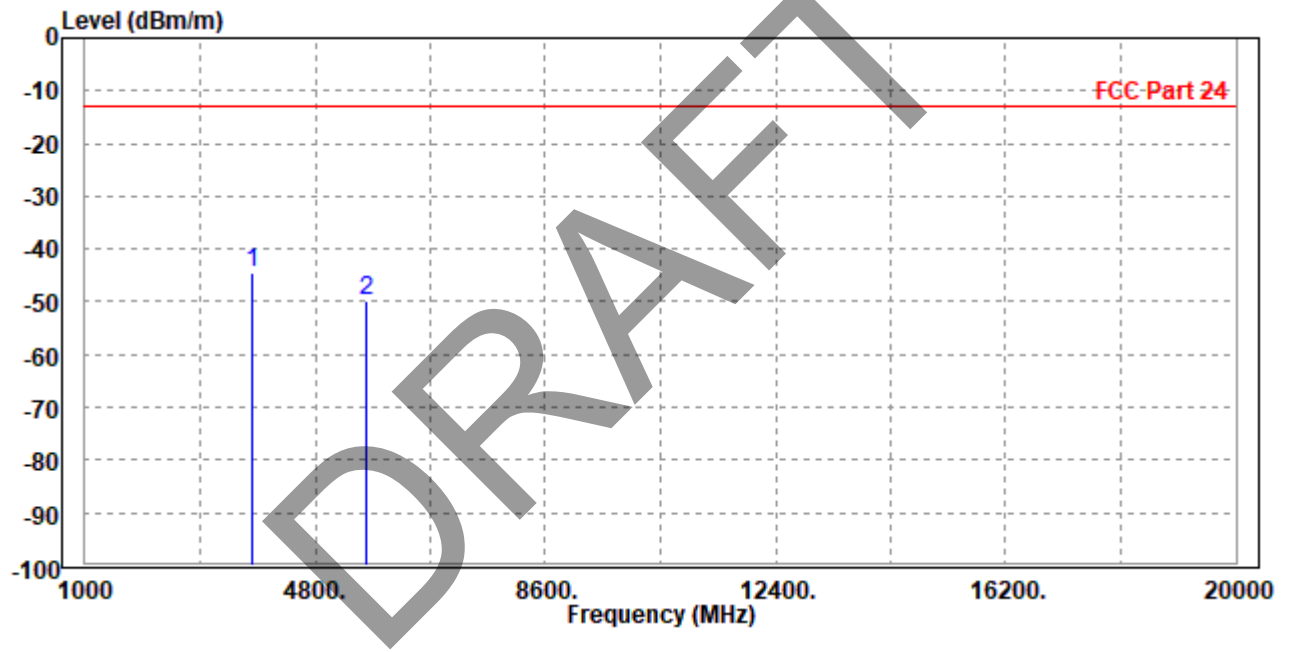



CH 810

MODE	TX channel 810	FREQUENCY RANGE	Above 1000MHz
ENVIRONMENTAL CONDITIONS	23deg. C, 70%RH	INPUT POWER	AC 120V/60HZ
TESTED BY	Jace Hu		
ANTENNA POLARITY & TEST DISTANCE: HORIZONTAL AT 3 M			

	Freq	Level	Read Level	Limit Line	Over Limit	Factor	Remark	Pol/Phase
	MHz	dBm/m	dBm	dBm/m	dB	dB/m		
1	PP 3819.600	-48.02	-56.32	-13.00	-35.02	8.30	Peak	Horizontal
2	5731.000	-49.24	-61.06	-13.00	-36.24	11.82	Peak	Horizontal

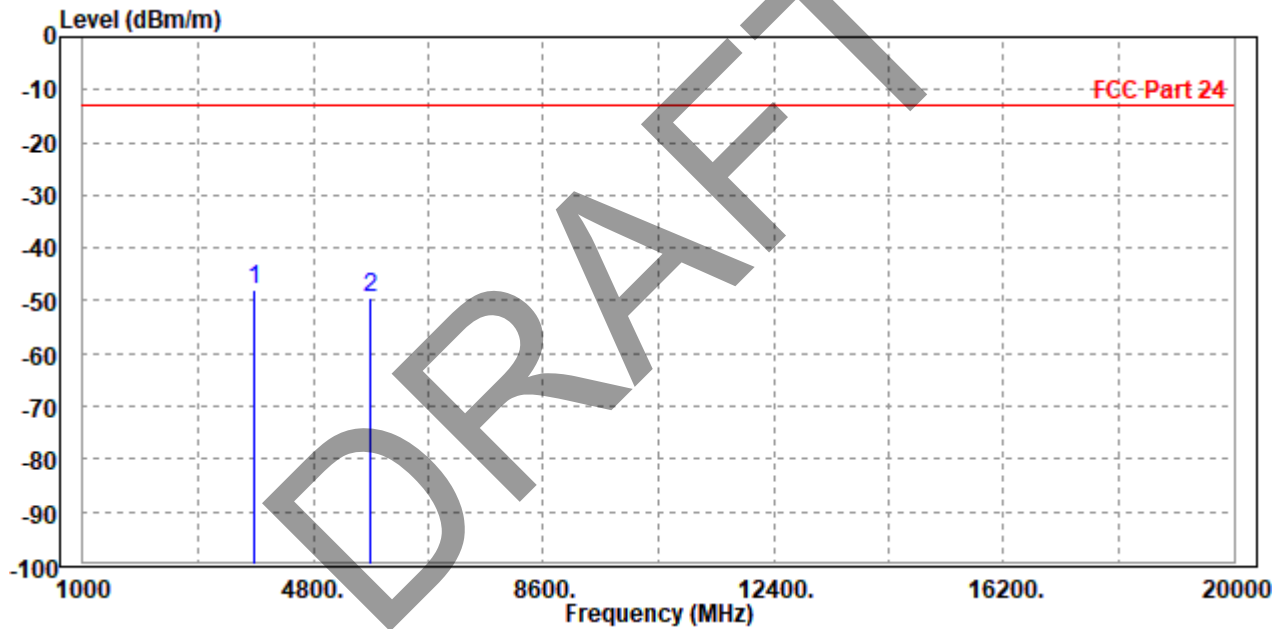



BUREAU VERITAS

Test Report No.: W7L-P23120015R102

MODE	TX channel 810	FREQUENCY RANGE	Above 1000MHz
ENVIRONMENTAL CONDITIONS	23deg. C, 70%RH	INPUT POWER	AC 120V/60HZ
TESTED BY	Jace Hu		
ANTENNA POLARITY & TEST DISTANCE: VERTICAL AT 3 M			

	Freq	Level	Read Level	Limit Line	Over Limit	Factor	Remark	Pol/Phase
	MHz	dBm/m	dBm	dBm/m	dB	dB/m		
1 PP	3812.000	-49.34	-57.97	-13.00	-36.34	8.63	Peak	Vertical
2	5729.400	-49.79	-62.10	-13.00	-36.79	12.31	Peak	Vertical

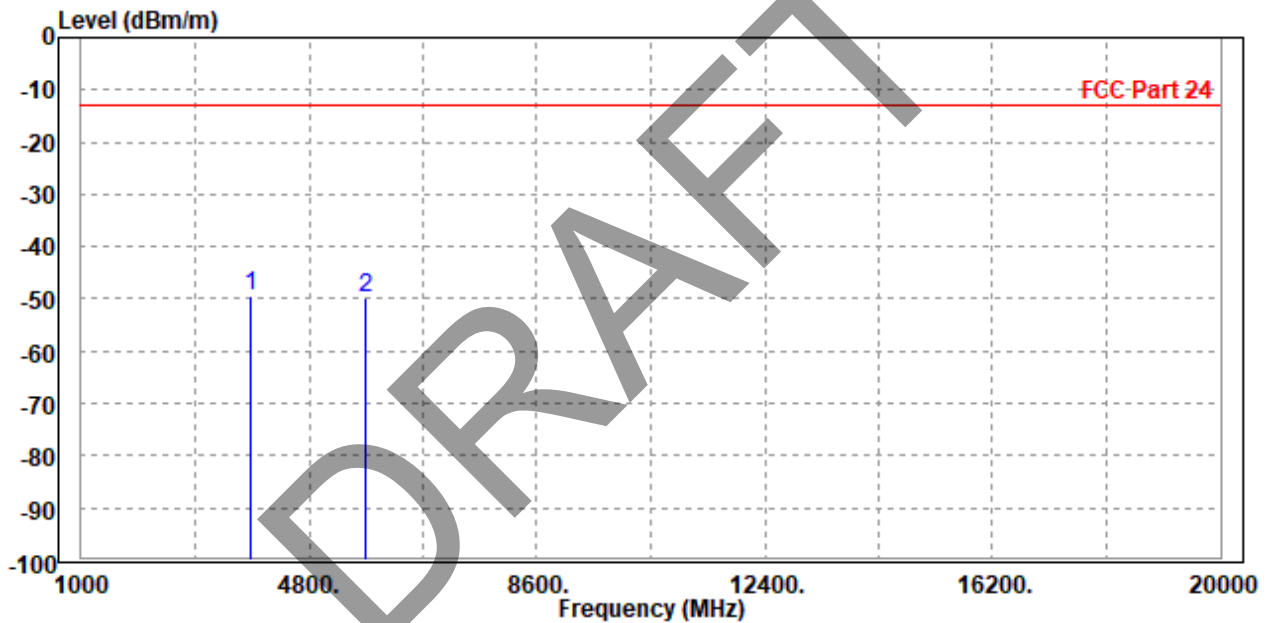



EDGE 1900:

CH 512

MODE	TX channel 512	FREQUENCY RANGE	Above 1000MHz
ENVIRONMENTAL CONDITIONS	23deg. C, 70%RH	INPUT POWER	AC 120V/60HZ
TESTED BY	Jace Hu		
ANTENNA POLARITY & TEST DISTANCE: HORIZONTAL AT 3 M			

	Freq	Level	Read Level	Limit Line	Over Limit	Factor	Remark	Pol/Phase
	MHz	dBm/m	dBm	dBm/m	dB	dB/m		
1	3698.000	-50.63	-59.03	-13.00	-37.63	8.40	Peak	Horizontal
2 PP	5550.600	-49.17	-60.97	-13.00	-36.17	11.80	Peak	Horizontal

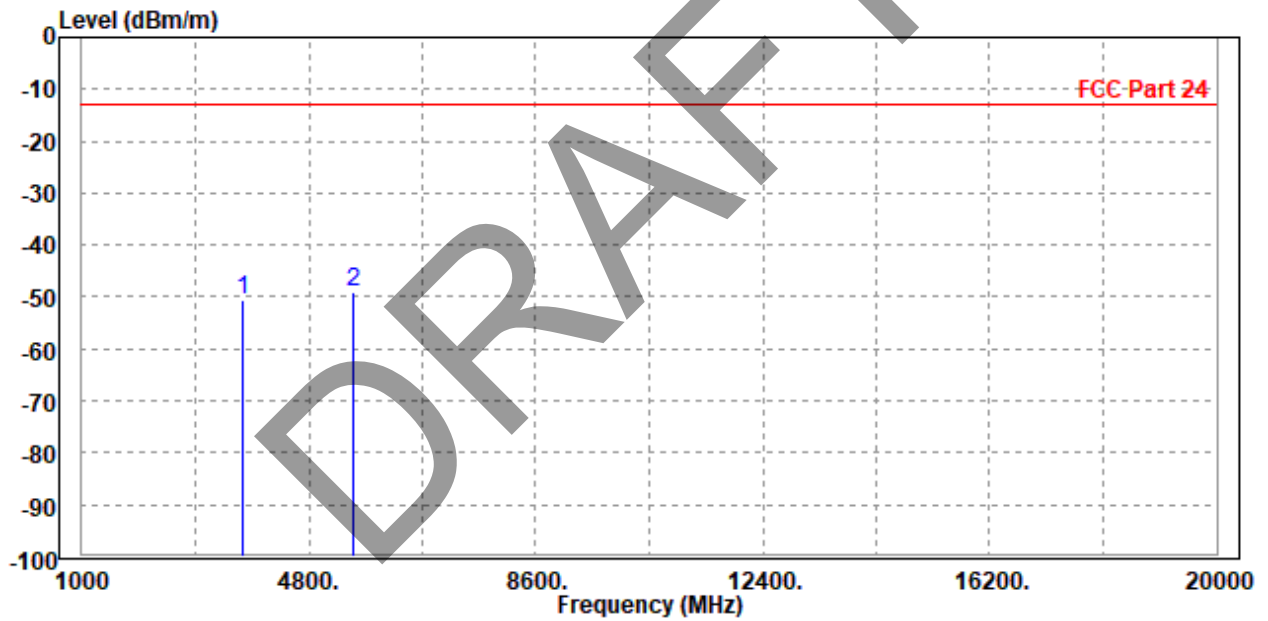



BUREAU VERITAS

Test Report No.: W7L-P23120015R102

MODE	TX channel 512	FREQUENCY RANGE	Above 1000MHz
ENVIRONMENTAL CONDITIONS	23deg. C, 70%RH	INPUT POWER	AC 120V/60HZ
TESTED BY	Jace Hu		
ANTENNA POLARITY & TEST DISTANCE: VERTICAL AT 3 M			

	Freq	Level	Read Level	Limit Line	Over Limit	Factor	Remark	Pol/Phase
	MHz	dBm/m	dBm	dBm/m	dB	dB/m		
1	3700.400	-51.82	-60.45	-13.00	-38.82	8.63	Peak	Vertical
2	PP 5560.000	-48.52	-60.85	-13.00	-35.52	12.33	Peak	Vertical

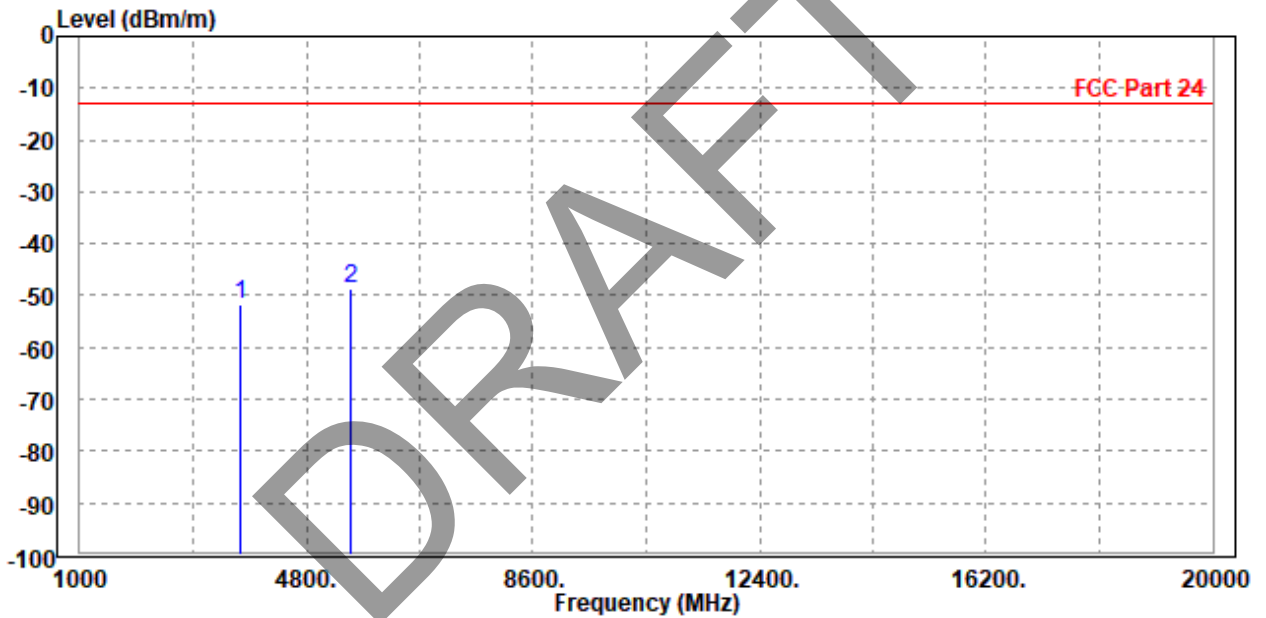



CH 661

MODE	TX channel 661	FREQUENCY RANGE	Above 1000MHz
ENVIRONMENTAL CONDITIONS	23deg. C, 70%RH	INPUT POWER	AC 120V/60HZ
TESTED BY	Jace Hu		
ANTENNA POLARITY & TEST DISTANCE: HORIZONTAL AT 3 M			

	Freq	Level	Read Level	Limit Line	Over Limit	Factor	Remark	Pol/Phase
	MHz	dBm/m	dBm	dBm/m	dB	dB/m		
1	3760.000	-49.96	-58.31	-13.00	-36.96	8.35	Peak	Horizontal
2 PP	5636.000	-48.67	-60.48	-13.00	-35.67	11.81	Peak	Horizontal

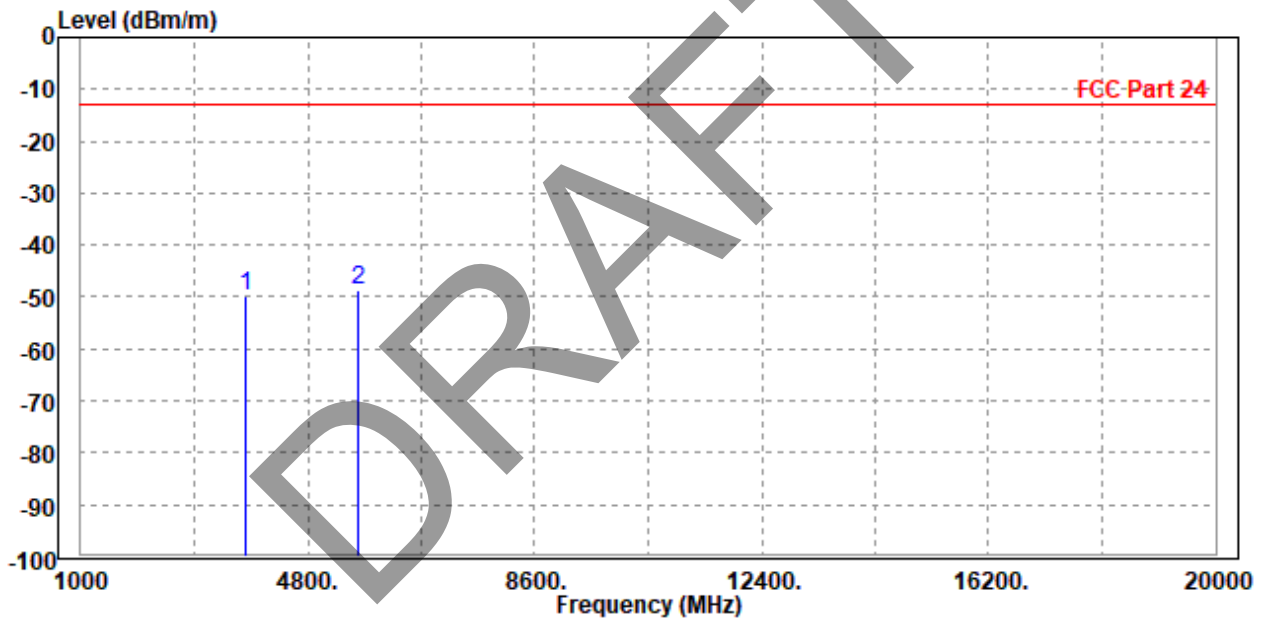



BUREAU VERITAS

Test Report No.: W7L-P23120015R102

MODE	TX channel 661	FREQUENCY RANGE	Above 1000MHz
ENVIRONMENTAL CONDITIONS	23deg. C, 70%RH	INPUT POWER	AC 120V/60HZ
TESTED BY	Jace Hu		
ANTENNA POLARITY & TEST DISTANCE: VERTICAL AT 3 M			

	Freq	Level	Read Level	Limit Line	Over Limit	Factor	Remark	Pol/Phase
	MHz	dBm/m	dBm	dBm/m	dB	dB/m		
1	3812.000	-50.26	-58.89	-13.00	-37.26	8.63	Peak	Vertical
2	PP 5640.000	-48.16	-60.48	-13.00	-35.16	12.32	Peak	Vertical

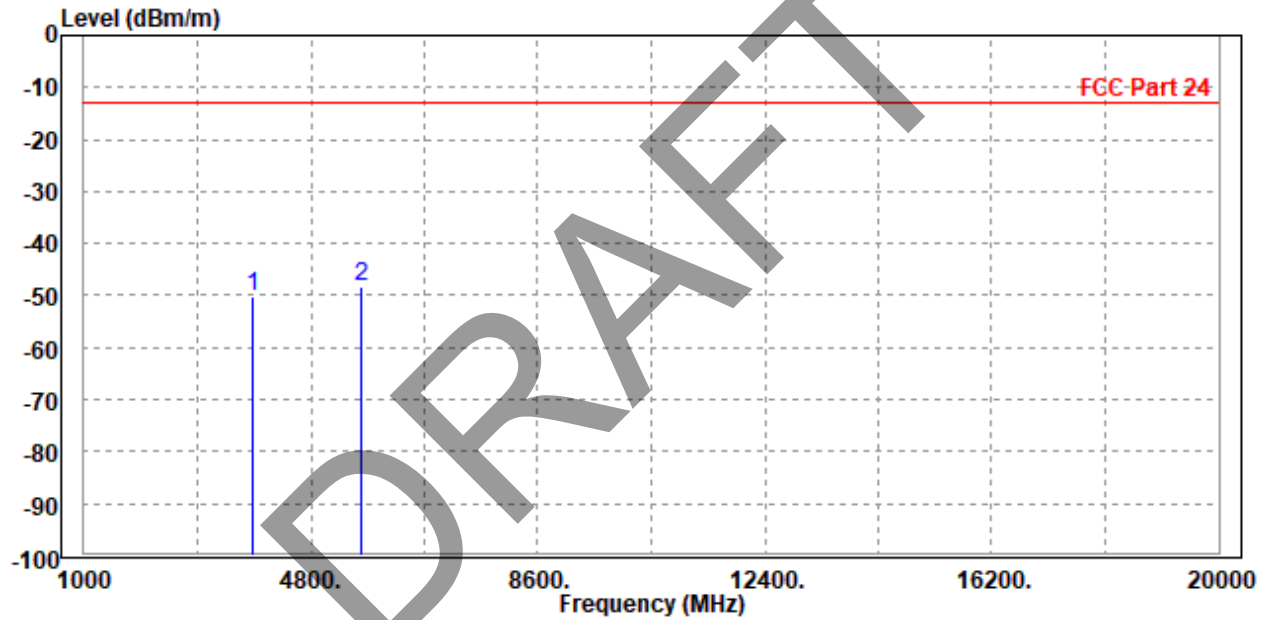



CH 810

MODE	TX channel 810	FREQUENCY RANGE	Above 1000MHz
ENVIRONMENTAL CONDITIONS	23deg. C, 70%RH	INPUT POWER	AC 120V/60HZ
TESTED BY	Jace Hu		
ANTENNA POLARITY & TEST DISTANCE: HORIZONTAL AT 3 M			

	Freq	Level	Read Level	Limit Line	Over Limit	Factor	Remark	Pol/Phase
	MHz	dBm/m	dBm	dBm/m	dB	dB/m		
1	3819.600	-50.34	-58.64	-13.00	-37.34	8.30	Peak	Horizontal
2 PP	5731.000	-49.30	-61.12	-13.00	-36.30	11.82	Peak	Horizontal

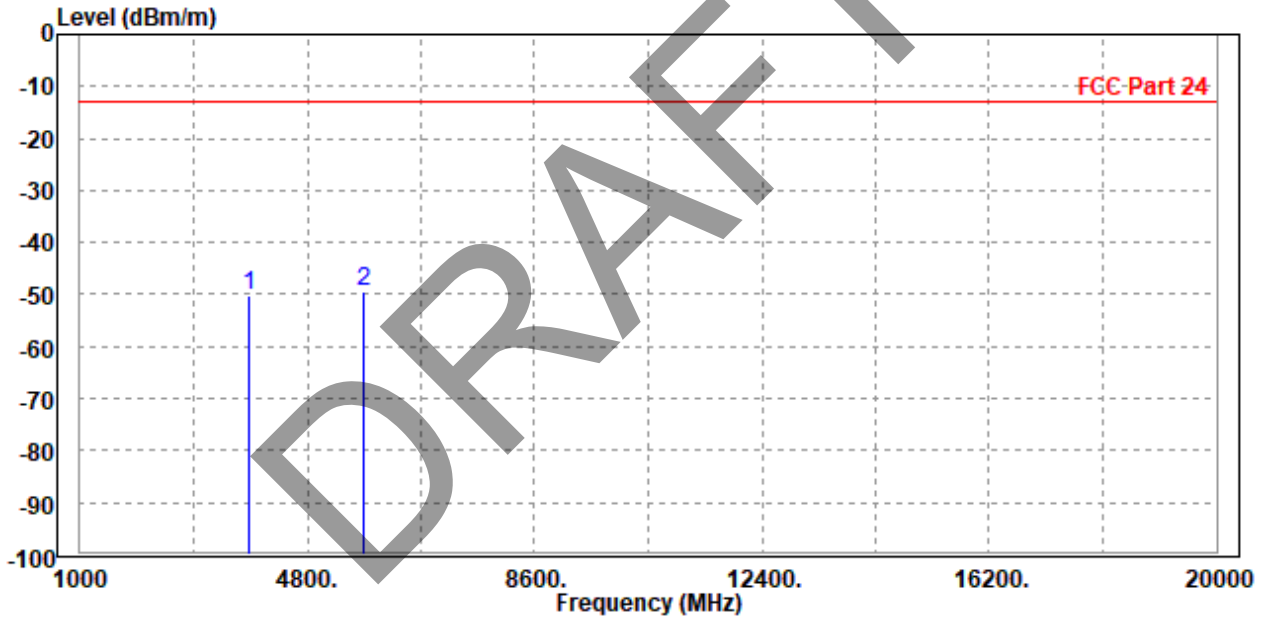



BUREAU VERITAS

Test Report No.: W7L-P23120015R102

MODE	TX channel 810	FREQUENCY RANGE	Above 1000MHz
ENVIRONMENTAL CONDITIONS	23deg. C, 70%RH	INPUT POWER	AC 120V/60HZ
TESTED BY	Jace Hu		
ANTENNA POLARITY & TEST DISTANCE: VERTICAL AT 3 M			

	Freq	Level	Read Level	Limit Line	Over Limit	Factor	Remark	Pol/Phase
	MHz	dBm/m	dBm	dBm/m	dB	dB/m		
1	3812.000	-51.48	-60.11	-13.00	-38.48	8.63	Peak	Vertical
2 PP	5729.400	-49.19	-61.50	-13.00	-36.19	12.31	Peak	Vertical

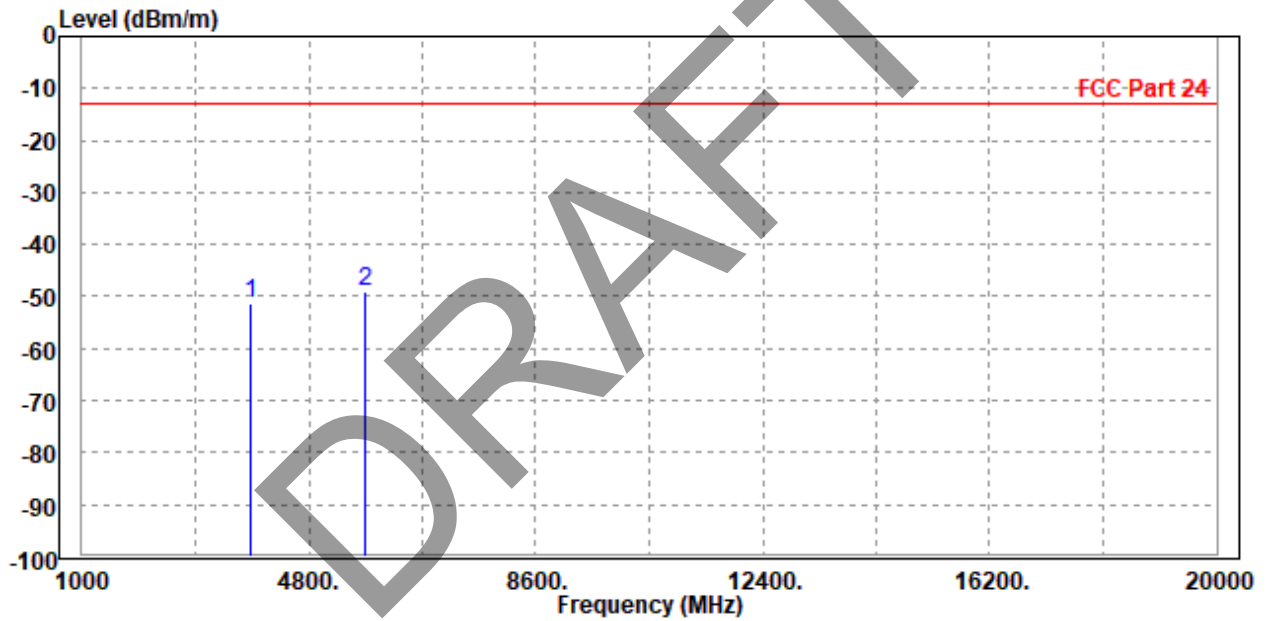



LTE Band 25

CHANNEL BANDWIDTH: 1.4MHz / QPSK

MODE	TX channel 26365	FREQUENCY RANGE	Above 1000MHz
ENVIRONMENTAL CONDITIONS	23deg. C, 70%RH	INPUT POWER	AC 120V/60HZ
TESTED BY	Jace Hu		
ANTENNA POLARITY & TEST DISTANCE: HORIZONTAL AT 3 M			

		Read	Limit	Over				
	Freq	Level	Level	Line	Limit	Factor	Remark	Pol/Phase
	MHz	dBm/m	dBm	dBm/m	dB	dB/m		
1	PP 3765.000	-48.47	-56.82	-13.00	-35.47	8.35	Peak	Horizontal
2	5655.000	-49.70	-61.51	-13.00	-36.70	11.81	Peak	Horizontal

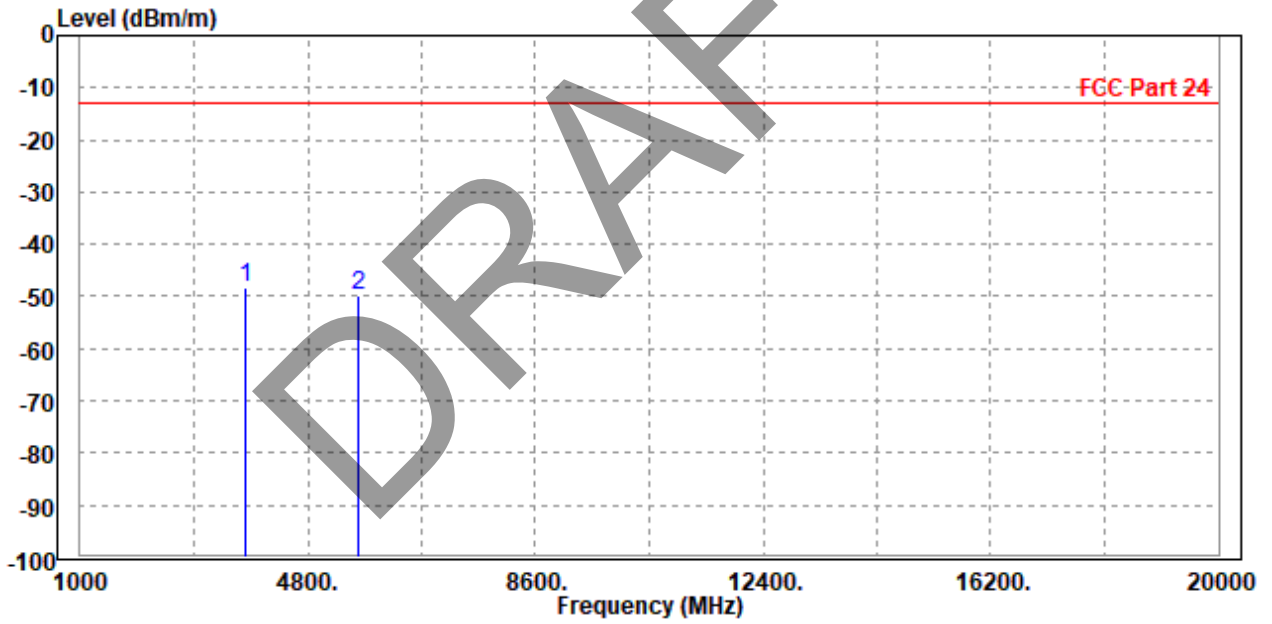



BUREAU VERITAS

Test Report No.: W7L-P23120015R102

MODE	TX channel 26365	FREQUENCY RANGE	Above 1000MHz
ENVIRONMENTAL CONDITIONS	23deg. C, 70%RH	INPUT POWER	AC 120V/60HZ
TESTED BY	Jace Hu		
ANTENNA POLARITY & TEST DISTANCE: VERTICAL AT 3 M			

	Freq	Level	Read Level	Limit Line	Over Limit	Factor	Remark	Pol/Phase
	MHz	dBm/m	dBm	dBm/m	dB	dB/m		
1	3774.000	-51.22	-59.85	-13.00	-38.22	8.63	Peak	Vertical
2 PP	5647.500	-47.73	-60.05	-13.00	-34.73	12.32	Peak	Vertical

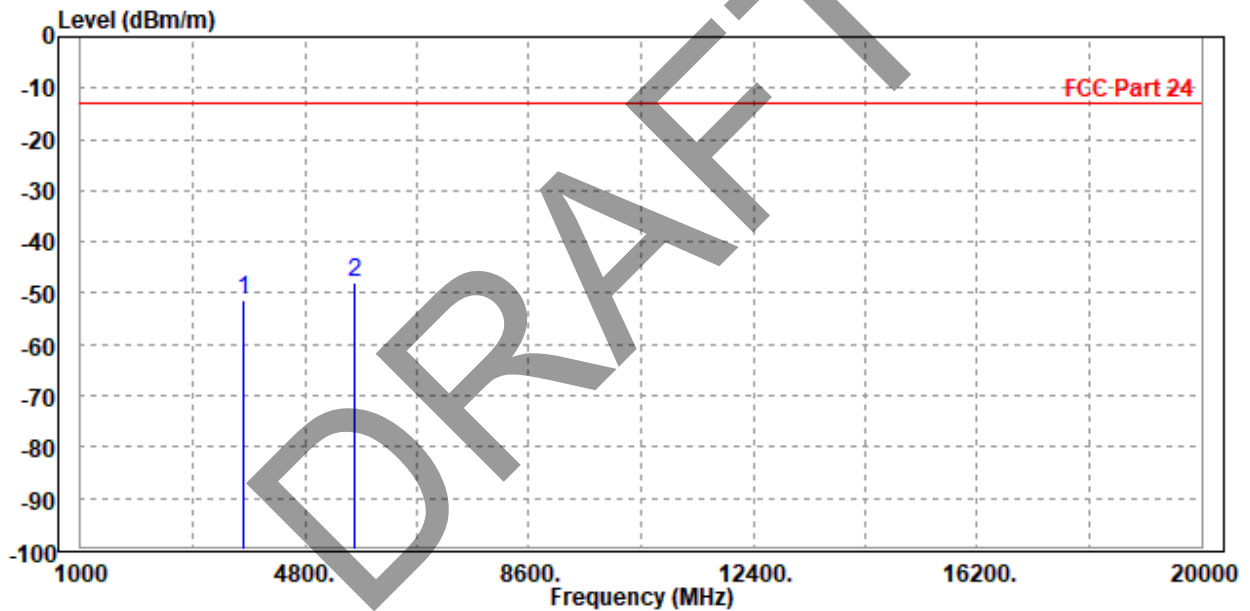



BUREAU VERITAS

Test Report No.: W7L-P23120015R102

CHANNEL BANDWIDTH: 3MHz / QPSK

CH 26055

MODE	TX channel 26055	FREQUENCY RANGE	Above 1000MHz
ENVIRONMENTAL CONDITIONS	23deg. C, 70%RH	INPUT POWER	AC 120V/60HZ
TESTED BY	Jace Hu		
ANTENNA POLARITY & TEST DISTANCE: HORIZONTAL AT 3 M			

	Freq	Level	Read Level	Limit Line	Over Limit	Factor	Remark	Pol/Phase
	MHz	dBm/m	dBm	dBm/m	dB	dB/m		
1	PP 3698.000	-49.46	-57.86	-13.00	-36.46	8.40	Peak	Horizontal
2	5554.500	-49.68	-61.48	-13.00	-36.68	11.80	Peak	Horizontal

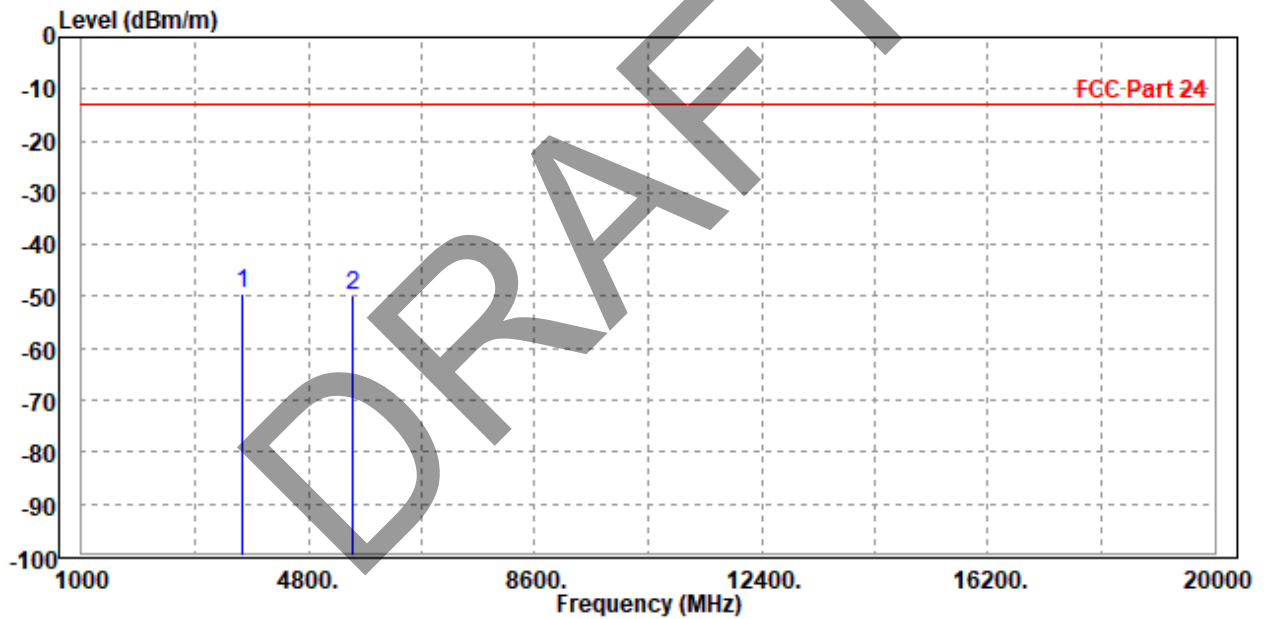



BUREAU VERITAS

Test Report No.: W7L-P23120015R102

MODE	TX channel 26055	FREQUENCY RANGE	Above 1000MHz
ENVIRONMENTAL CONDITIONS	23deg. C, 70%RH	INPUT POWER	AC 120V/60HZ
TESTED BY	Jace Hu		
ANTENNA POLARITY & TEST DISTANCE: VERTICAL AT 3 M			

	Freq	Level	Read Level	Limit Line	Over Limit	Factor	Remark	Pol/Phase
	MHz	dBm/m	dBm	dBm/m	dB	dB/m		
1	3703.000	-51.49	-60.12	-13.00	-38.49	8.63	Peak	Vertical
2	PP 5560.000	-49.02	-61.35	-13.00	-36.02	12.33	Peak	Vertical

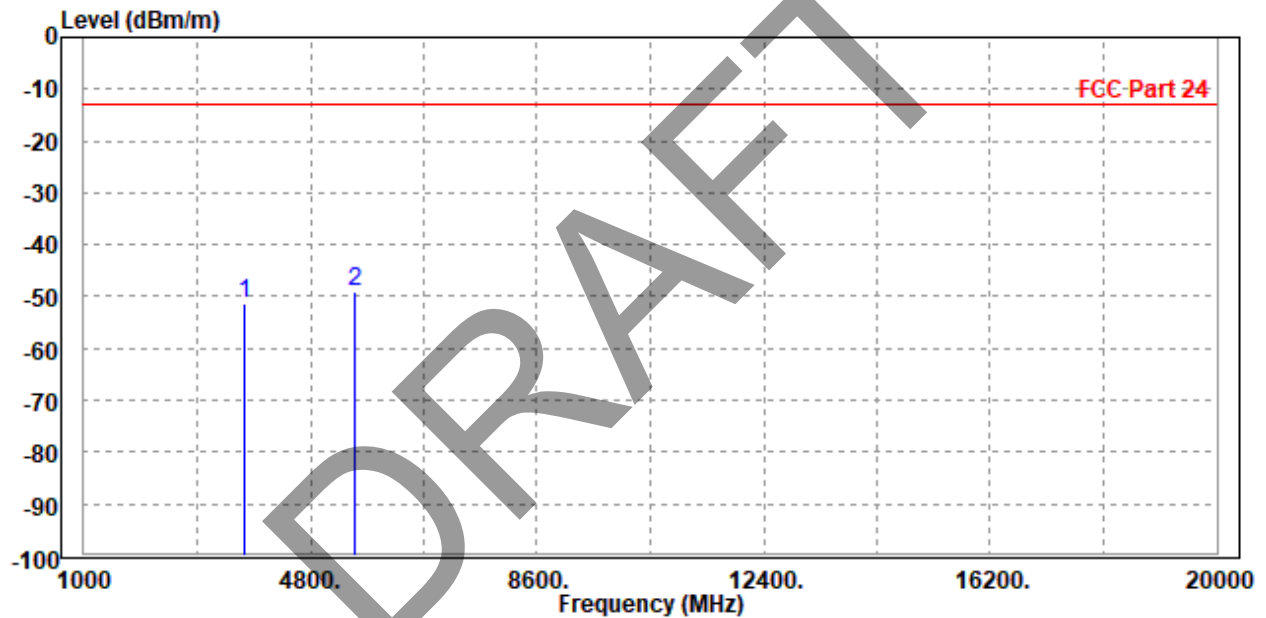



CH 26365

MODE	TX channel 26365	FREQUENCY RANGE	Above 1000MHz
ENVIRONMENTAL CONDITIONS	23deg. C, 70%RH	INPUT POWER	AC 120V/60HZ
TESTED BY	Jace Hu		
ANTENNA POLARITY & TEST DISTANCE: HORIZONTAL AT 3 M			

	Freq	Level	Read Level	Limit Line	Over Limit	Factor	Remark	Pol/Phase
	MHz	dBm/m	dBm	dBm/m	dB	dB/m		
1	PP 3774.000	-49.09	-57.43	-13.00	-36.09	8.34	Peak	Horizontal
2	5647.500	-49.41	-61.22	-13.00	-36.41	11.81	Peak	Horizontal

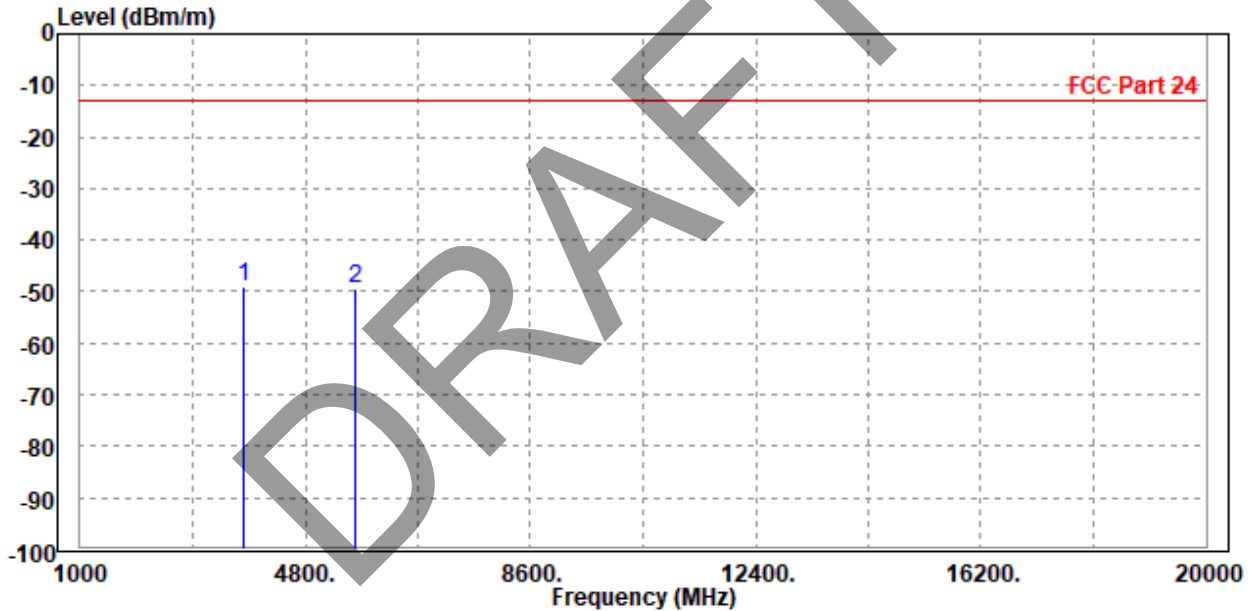



MODE	TX channel 26365	FREQUENCY RANGE	Above 1000MHz
ENVIRONMENTAL CONDITIONS	23deg. C, 70%RH	INPUT POWER	AC 120V/60HZ
TESTED BY	Jace Hu		
ANTENNA POLARITY & TEST DISTANCE: VERTICAL AT 3 M			

	Freq	Level	Read Level	Limit Line	Over Limit	Factor	Remark	Pol/Phase
	MHz	dBm/m	dBm	dBm/m	dB	dB/m		
1	PP 3765.000	-46.17	-54.80	-13.00	-33.17	8.63	Peak	Vertical
2	5655.000	-49.85	-62.17	-13.00	-36.85	12.32	Peak	Vertical

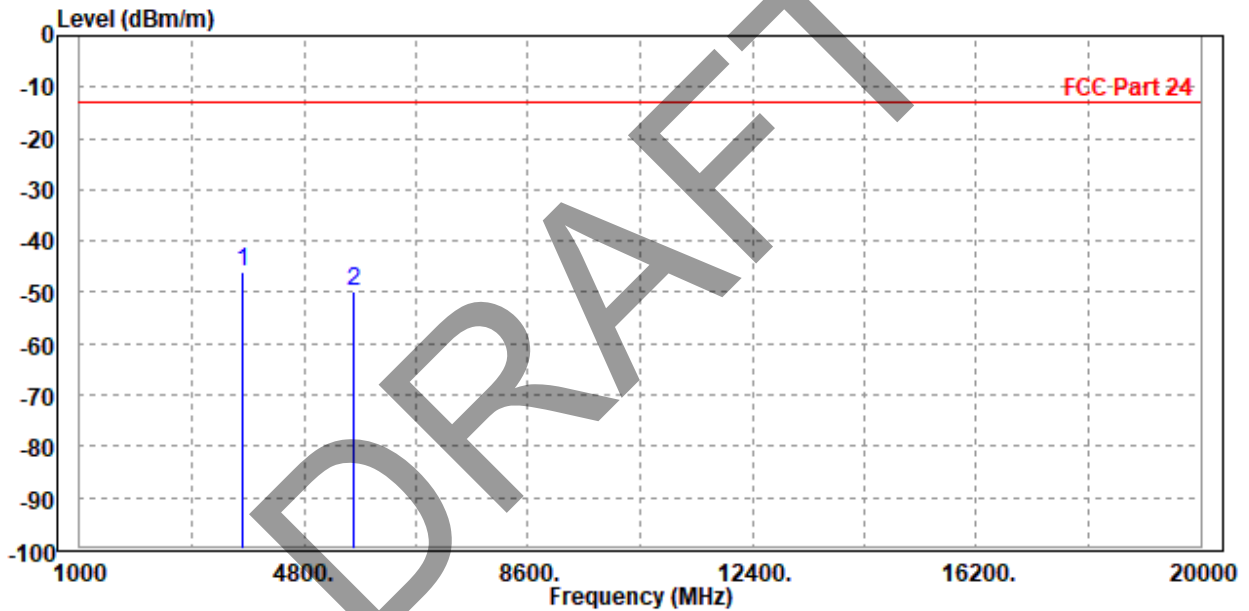



BUREAU VERITAS

Test Report No.: W7L-P23120015R102

CH 26675

MODE	TX channel 26675	FREQUENCY RANGE	Above 1000MHz
ENVIRONMENTAL CONDITIONS	23deg. C, 70%RH	INPUT POWER	AC 120V/60HZ
TESTED BY	Jace Hu		
ANTENNA POLARITY & TEST DISTANCE: HORIZONTAL AT 3 M			

	Freq	Level	Read Level	Limit Line	Over Limit	Factor	Remark	Pol/Phase
	MHz	dBm/m	dBm	dBm/m	dB	dB/m		
1	3827.000	-50.40	-58.70	-13.00	-37.40	8.30	Peak	Horizontal
2 PP	5750.000	-49.00	-60.82	-13.00	-36.00	11.82	Peak	Horizontal

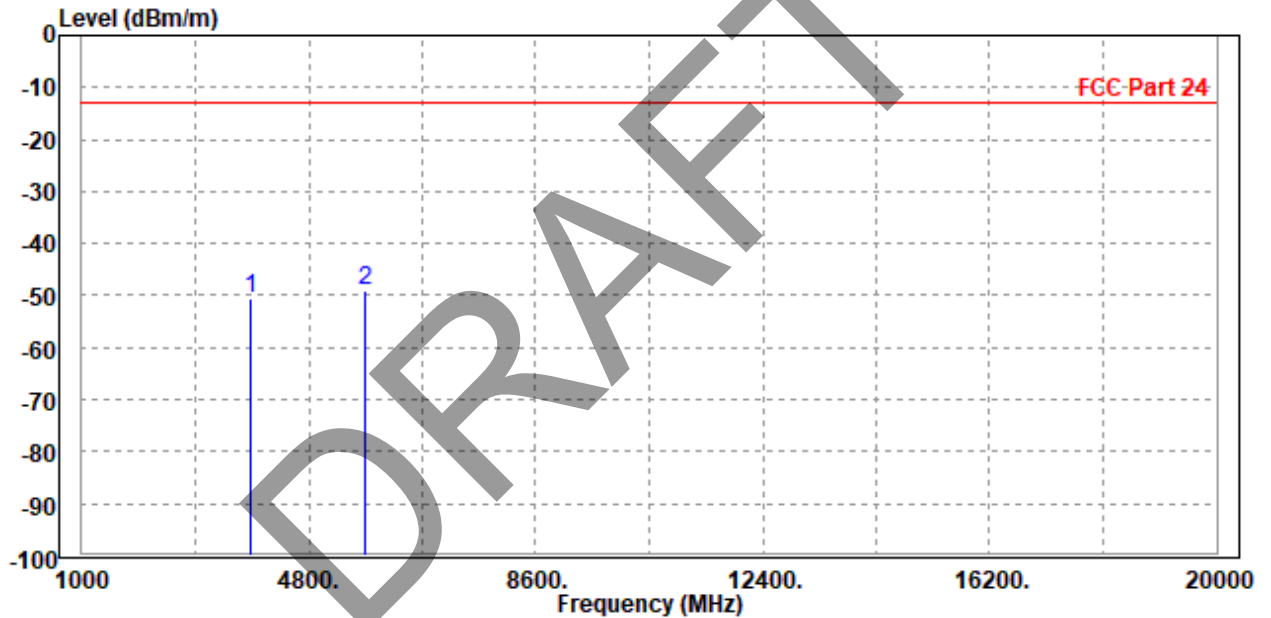



BUREAU VERITAS

Test Report No.: W7L-P23120015R102

MODE	TX channel 26675	FREQUENCY RANGE	Above 1000MHz
ENVIRONMENTAL CONDITIONS	23deg. C, 70%RH	INPUT POWER	AC 120V/60HZ
TESTED BY	Jace Hu		
ANTENNA POLARITY & TEST DISTANCE: VERTICAL AT 3 M			

	Read	Limit	Over				
Freq	Level	Level	Line	Limit	Factor	Remark	Pol/Phase
MHz	dBm/m	dBm	dBm/m	dB	dB/m		
1 PP 3831.000	-47.24	-55.87	-13.00	-34.24	8.63	Peak	Vertical
2 5740.500	-48.46	-60.77	-13.00	-35.46	12.31	Peak	Vertical

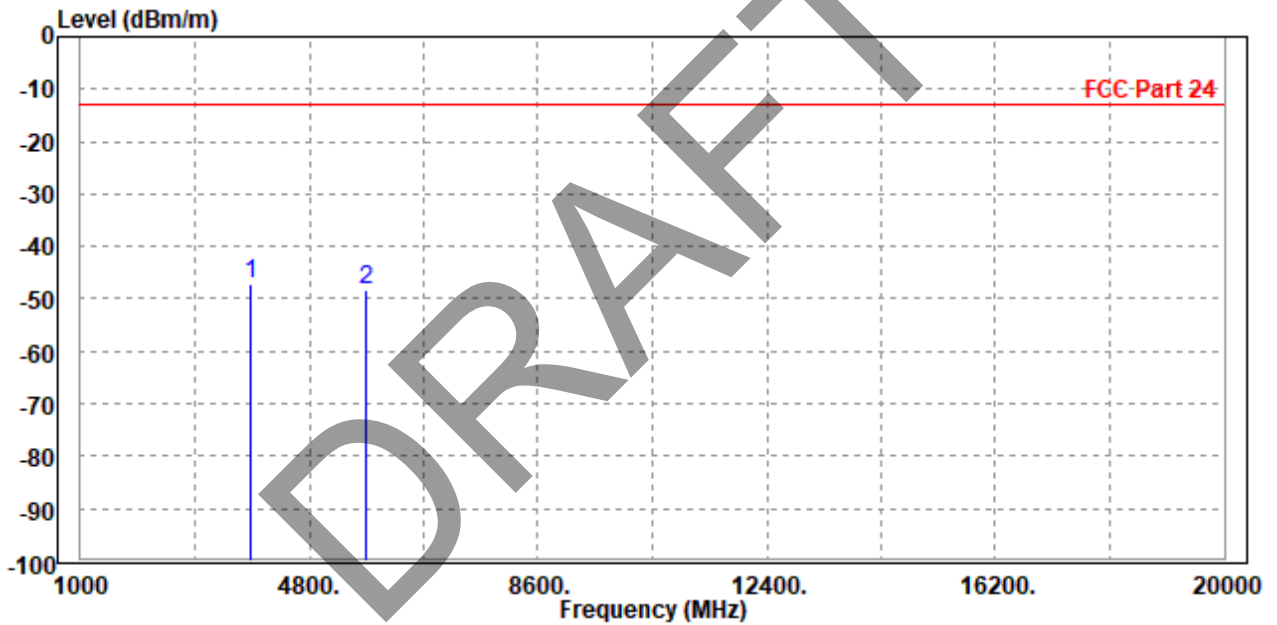



CHANNEL BANDWIDTH: 5MHz / QPSK

MODE	TX channel 26365	FREQUENCY RANGE	Above 1000MHz
ENVIRONMENTAL CONDITIONS	23deg. C, 70%RH	INPUT POWER	AC 120V/60HZ
TESTED BY	Jace Hu		
ANTENNA POLARITY & TEST DISTANCE: HORIZONTAL AT 3 M			

	Freq	Level	Read Level	Limit Line	Over Limit	Factor	Remark	Pol/Phase
	MHz	dBm/m	dBm	dBm/m	dB	dB/m		
1	PP 3765.000	-48.49	-56.84	-13.00	-35.49	8.35	Peak	Horizontal
2	5655.000	-48.89	-60.70	-13.00	-35.89	11.81	Peak	Horizontal

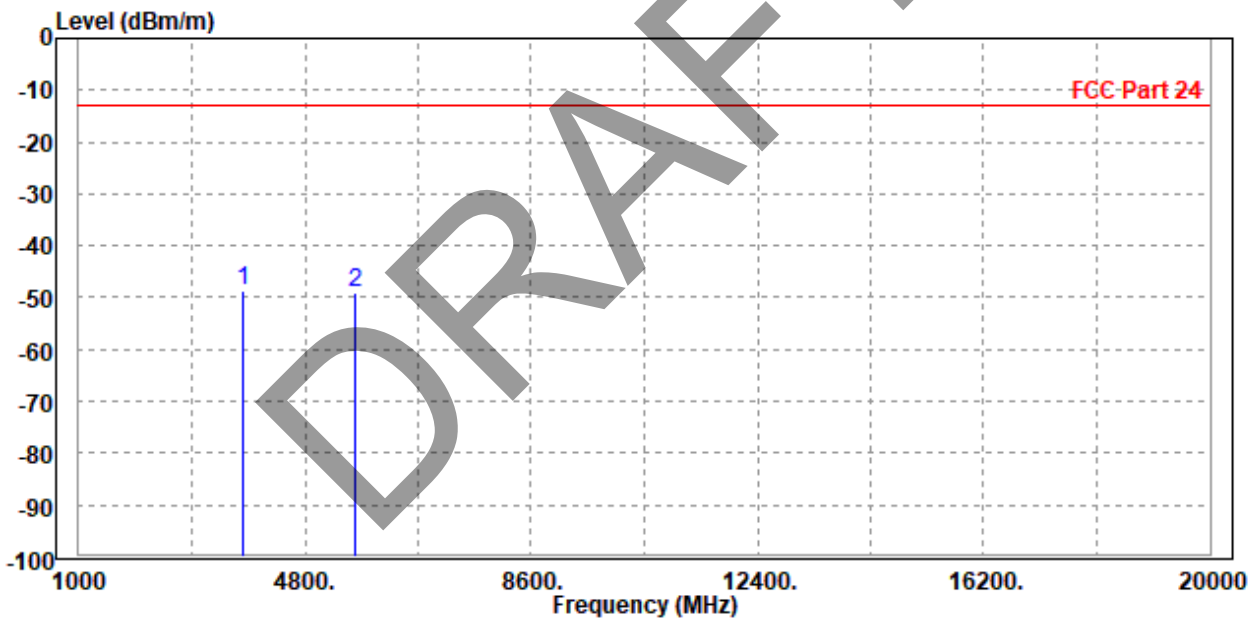



MODE	TX channel 26365	FREQUENCY RANGE	Above 1000MHz
ENVIRONMENTAL CONDITIONS	23deg. C, 70%RH	INPUT POWER	AC 120V/60HZ
TESTED BY	Jace Hu		
ANTENNA POLARITY & TEST DISTANCE: VERTICAL AT 3 M			

	Freq	Level	Read Level	Limit Line	Over Limit	Factor	Remark	Pol/Phase
	MHz	dBm/m	dBm	dBm/m	dB	dB/m		
1	PP 3774.000	-48.23	-56.86	-13.00	-35.23	8.63	Peak	Vertical
2	5647.500	-49.26	-61.58	-13.00	-36.26	12.32	Peak	Vertical

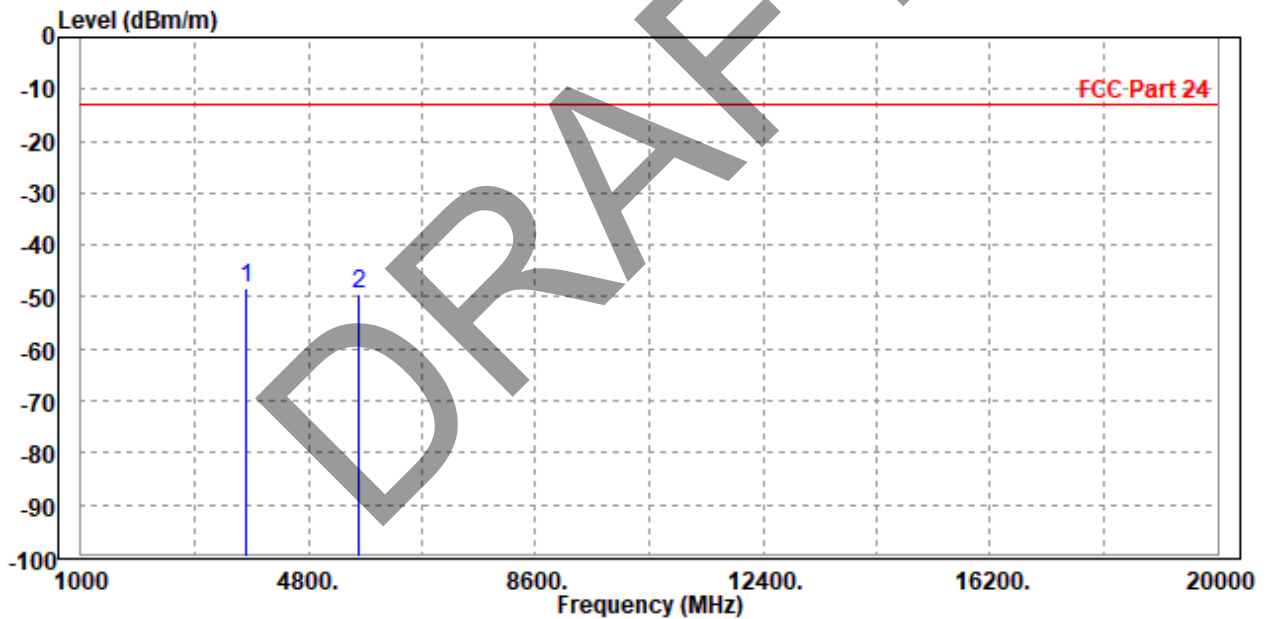



CHANNEL BANDWIDTH: 10MHz / QPSK

MODE	TX channel 26365	FREQUENCY RANGE	Above 1000MHz
ENVIRONMENTAL CONDITIONS	23deg. C, 70%RH	INPUT POWER	AC 120V/60HZ
TESTED BY	Jace Hu		
ANTENNA POLARITY & TEST DISTANCE: HORIZONTAL AT 3 M			

	Freq	Level	Read Level	Limit Line	Over Limit	Factor	Remark	Pol/Phase
	MHz	dBm/m	dBm	dBm/m	dB	dB/m		
1	3765.000	-49.61	-57.96	-13.00	-36.61	8.35	Peak	Horizontal
2 PP	5655.000	-48.18	-59.99	-13.00	-35.18	11.81	Peak	Horizontal

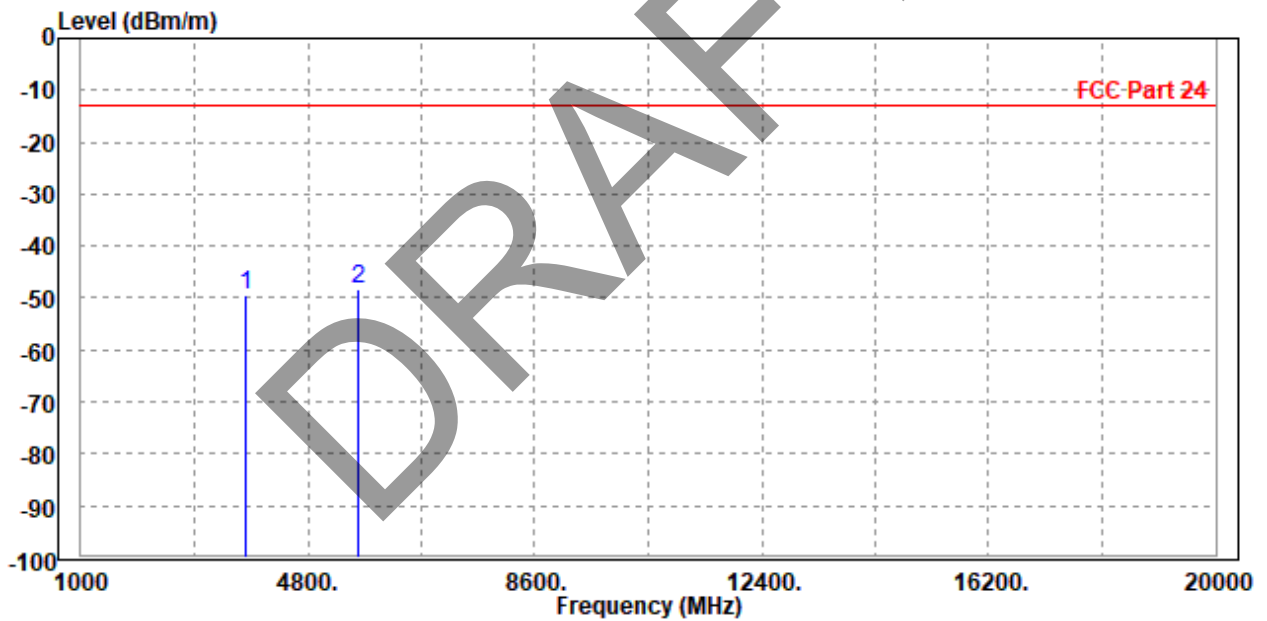



**BUREAU
VERITAS**

Test Report No.: W7L-P23120015R102

MODE	TX channel 26365	FREQUENCY RANGE	Above 1000MHz
ENVIRONMENTAL CONDITIONS	23deg. C, 70%RH	INPUT POWER	AC 120V/60HZ
TESTED BY	Jace Hu		
ANTENNA POLARITY & TEST DISTANCE: VERTICAL AT 3 M			

	Freq	Level	Read Level	Limit Line	Over Limit	Factor	Remark	Pol/Phase
	MHz	dBm/m	dBm	dBm/m	dB	dB/m		
1	3470.000	-51.89	-60.54	-13.00	-38.89	8.65	Peak	Vertical
2 PP	5647.500	-48.60	-60.92	-13.00	-35.60	12.32	Peak	Vertical

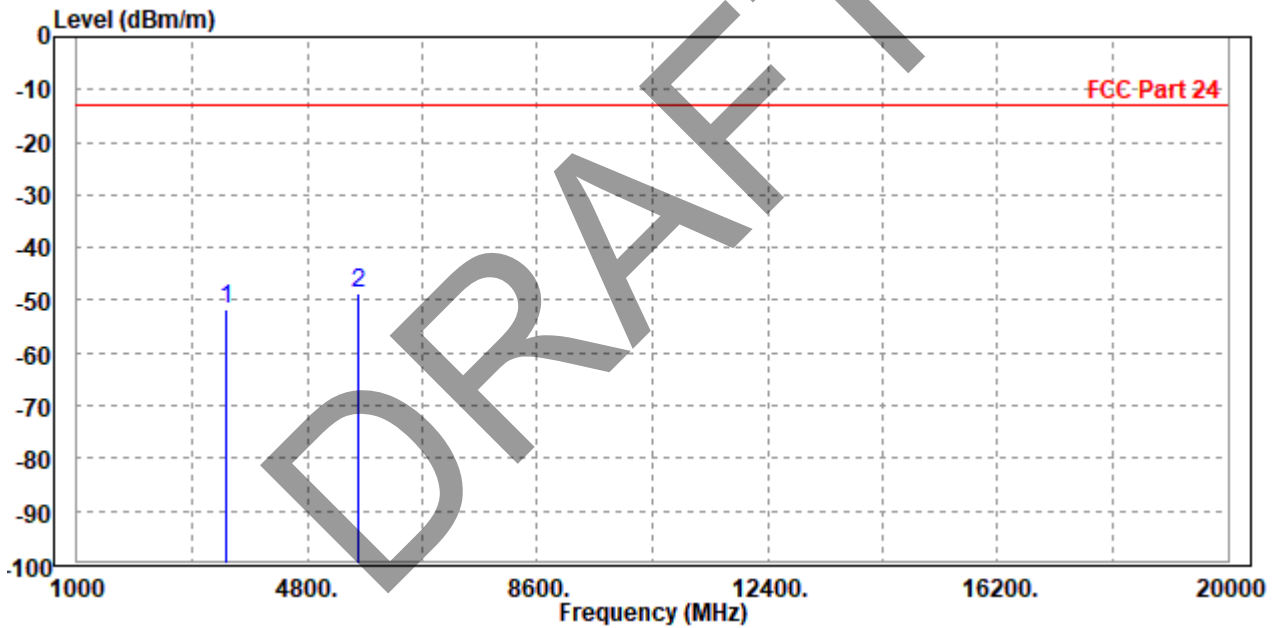



CHANNEL BANDWIDTH: 15MHz / QPSK

MODE	TX channel 26365	FREQUENCY RANGE	Above 1000MHz
ENVIRONMENTAL CONDITIONS	23deg. C, 70%RH	INPUT POWER	AC 120V/60HZ
TESTED BY	Jace Hu		
ANTENNA POLARITY & TEST DISTANCE: HORIZONTAL AT 3 M			

	Freq	Level	Read Level	Limit Line	Over Limit	Factor	Remark	Pol/Phase
	MHz	dBm/m	dBm	dBm/m	dB	dB/m		
1	3774.000	-53.19	-61.53	-13.00	-40.19	8.34	Peak	Horizontal
2 PP	5647.500	-50.30	-62.11	-13.00	-37.30	11.81	Peak	Horizontal

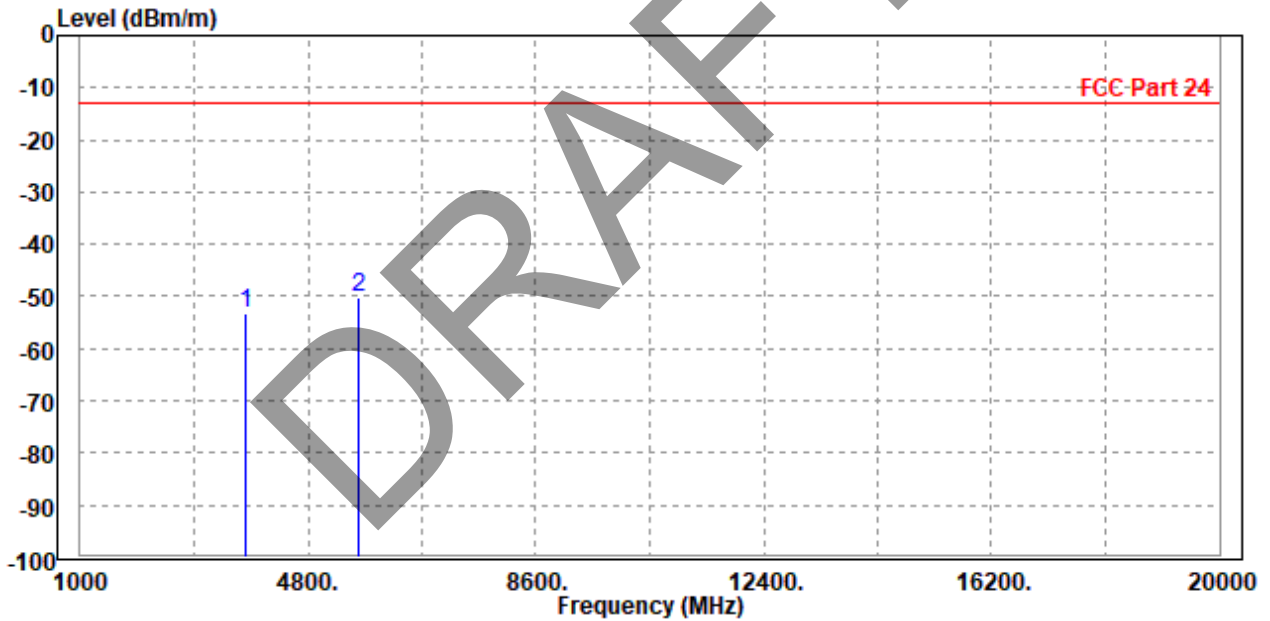



MODE	TX channel 26365	FREQUENCY RANGE	Above 1000MHz
ENVIRONMENTAL CONDITIONS	23deg. C, 70%RH	INPUT POWER	AC 120V/60HZ
TESTED BY	Jace Hu		
ANTENNA POLARITY & TEST DISTANCE: VERTICAL AT 3 M			

	Freq	Level	Read Level	Limit Line	Over Limit	Factor	Remark	Pol/Phase
	MHz	dBm/m	dBm	dBm/m	dB	dB/m		
1	3765.000	-49.62	-58.25	-13.00	-36.62	8.63	Peak	Vertical
2	PP 5655.000	-49.16	-61.48	-13.00	-36.16	12.32	Peak	Vertical

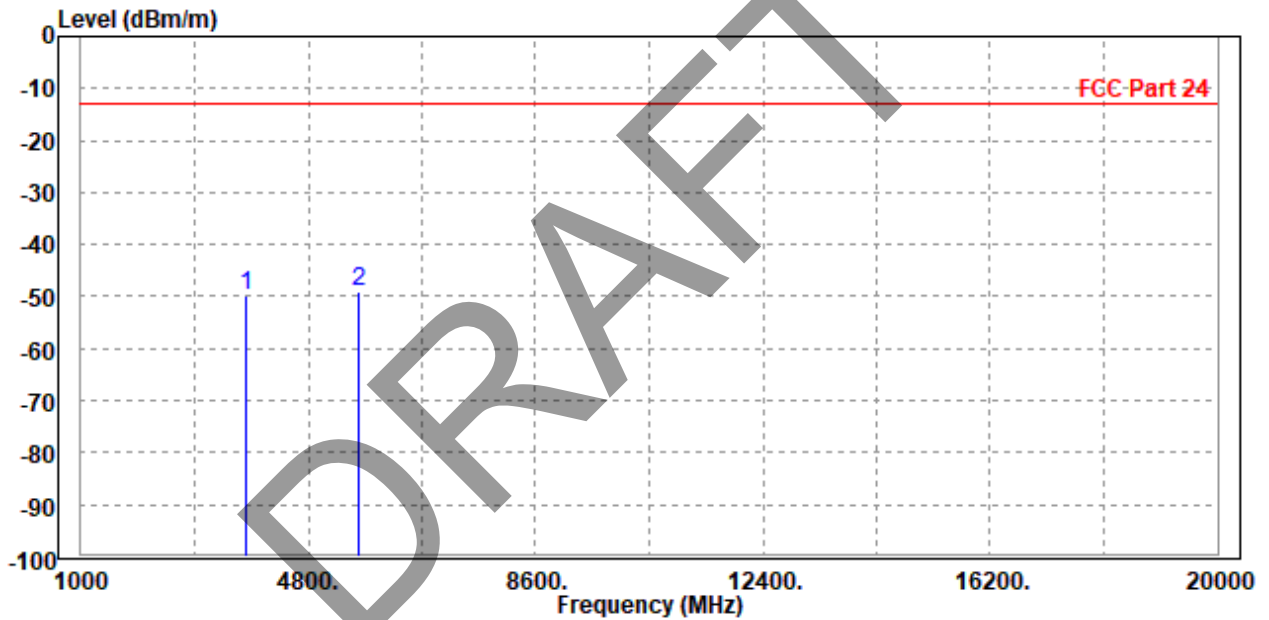



CHANNEL BANDWIDTH: 20MHz / QPSK

MODE	TX channel 26365	FREQUENCY RANGE	Above 1000MHz
ENVIRONMENTAL CONDITIONS	23deg. C, 70%RH	INPUT POWER	AC 120V/60HZ
TESTED BY	Jace Hu		
ANTENNA POLARITY & TEST DISTANCE: HORIZONTAL AT 3 M			

	Freq	Level	Read Level	Limit Line	Over Limit	Factor	Remark	Pol/Phase
	MHz	dBm/m	dBm	dBm/m	dB	dB/m		
1	3765.000	-50.17	-58.52	-13.00	-37.17	8.35	Peak	Horizontal
2 PP	5655.000	-49.37	-61.18	-13.00	-36.37	11.81	Peak	Horizontal

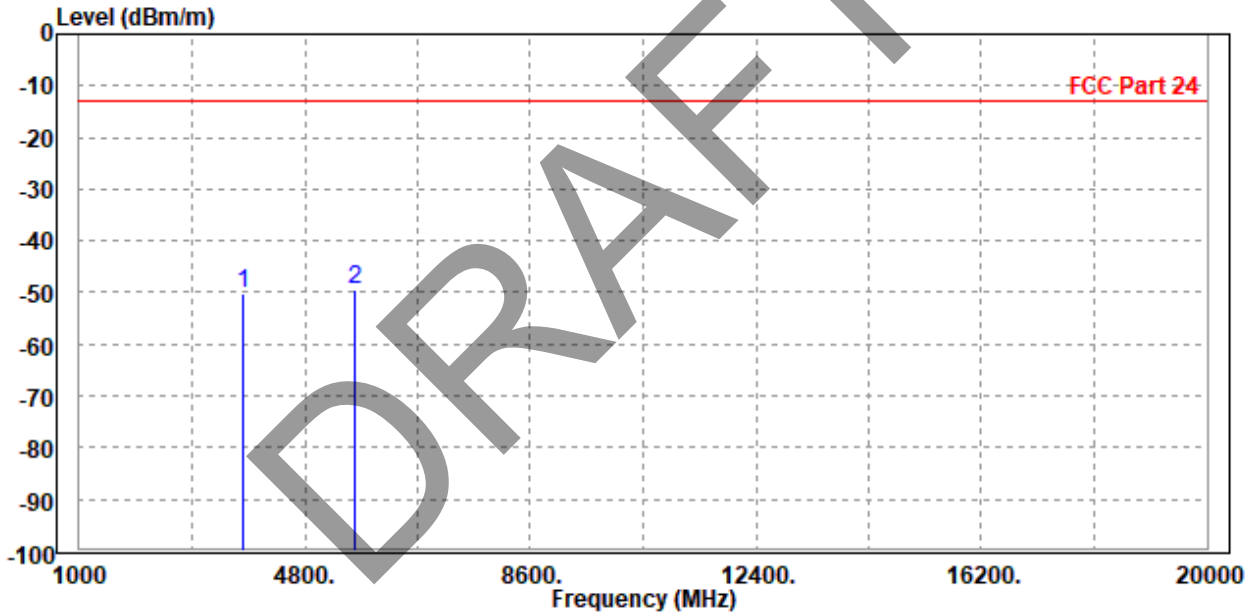



MODE	TX channel 26365	FREQUENCY RANGE	Above 1000MHz
ENVIRONMENTAL CONDITIONS	23deg. C, 70%RH	INPUT POWER	AC 120V/60HZ
TESTED BY	Jace Hu		
ANTENNA POLARITY & TEST DISTANCE: VERTICAL AT 3 M			

	Freq	Level	Read Level	Limit Line	Over Limit	Factor	Remark	Pol/Phase
	MHz	dBm/m	dBm	dBm/m	dB	dB/m		
1	PP 3774.000	-47.98	-56.61	-13.00	-34.98	8.63	Peak	Vertical
2	5647.500	-48.87	-61.19	-13.00	-35.87	12.32	Peak	Vertical

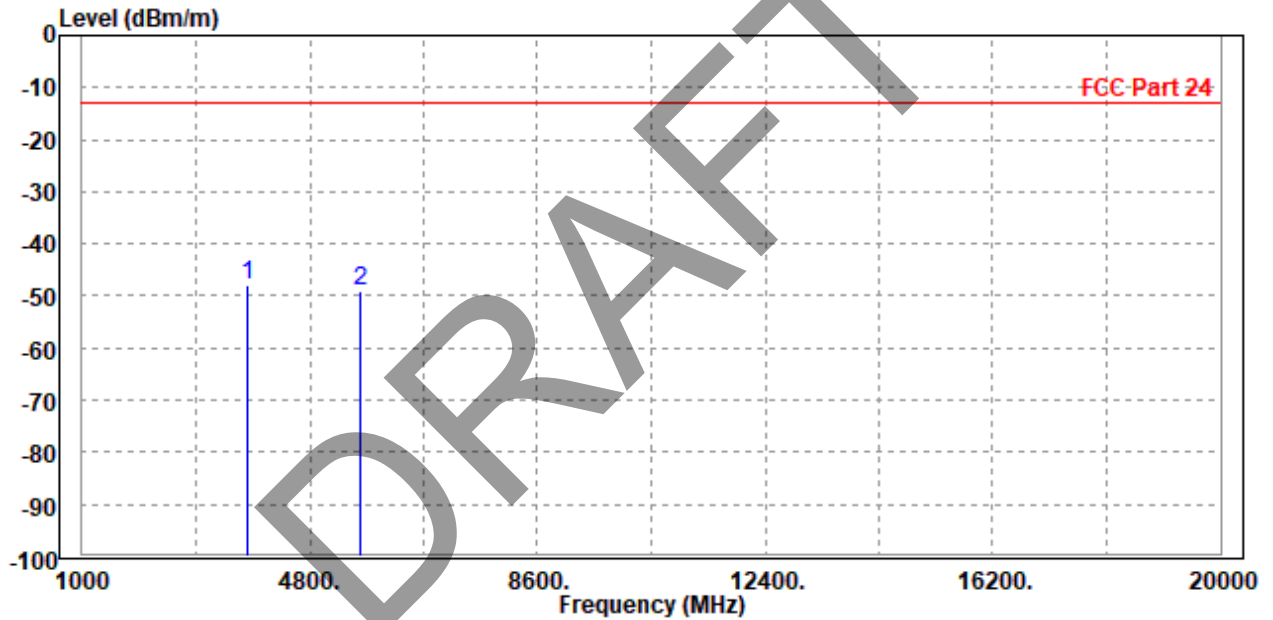



4.7 RECEIVER SPURIOUS EMISSIONS

4.7.1 LIMITS OF RADIATED EMISSION MEASUREMENT

Spurious emissions from receivers shall not exceed the radiated emission limits shown in follow table

Frequency(MHz)	Field strength(Uv/m at 3 metres)
30~88	100
88~216	150
216~960	200
Above 960	500

NOTE:

1. The lower limit shall apply at the transition frequencies.
2. Emission level (dBuV/m) = 20 log Emission level (uV/m).

DRAFT



4.7.2 TEST PROCEDURES

- a. The EUT was placed on the top of a rotating table 0.8 meters (for below 1GHz) / 1.5 meters (for above 1GHz) above the ground at a 3 meter chamber. The table was rotated 360 degrees to determine the position of the highest radiation.
- b. The EUT was set 3 meters away from the interference-receiving antenna, which was mounted on the top of a variable-height antenna tower.
- c. The antenna is a broadband antenna, and its height is varied from one meter to four meters above the ground to determine the maximum value of the field strength. Both horizontal and vertical polarizations of the antenna are set to make the measurement.
- d. For each suspected emission, the EUT was arranged to its worst case and then the antenna was tuned to heights from 1 meter to 4 meters and the rotatable table was turned from 0 degrees to 360 degrees to find the maximum reading.
- e. The test-receiver system was set to Peak Detect Function and Specified Bandwidth with Maximum Hold Mode.
- f. During the test, each emission was maximized by: having the EUT continuously working, investigated all operating modes, rotated about all 3 axis (X, Y & Z) and considered typical configuration to obtain worst position, manipulating interconnecting cables, For battery operated equipment, the equipment tests shall be perform using fresh batteries. The turntable was rotated to maximize the emission level.

NOTE:

1. The resolution bandwidth and video bandwidth of test receiver/spectrum analyzer is 120kHz for Quasi-peak detection at frequency below 1GHz.
2. The resolution bandwidth of test receiver/spectrum analyzer is 1 MHz and video bandwidth is 3MHz for Peak detection at frequency above 1GHz.
3. The resolution bandwidth of test receiver/spectrum analyzer is 1MHz and the video bandwidth is 10Hz for Average detection (AV) at frequency above 1GHz.
4. If the dwell time per channel of the hopping signal is less than 100 ms, then the reading obtained with the 10 Hz VBW may be further adjusted by a "duty cycle correction factor", derived from $20\log(\text{dwell time}/100 \text{ ms})$, in an effort to demonstrate compliance with the 15.209 limit.
5. All modes of operation were investigated and the worst-case emissions are reported.

4.7.3 DEVIATION FROM TEST STANDARD

No deviation



4.7.4 TEST SETUP

< Frequency Range below 30MHz >

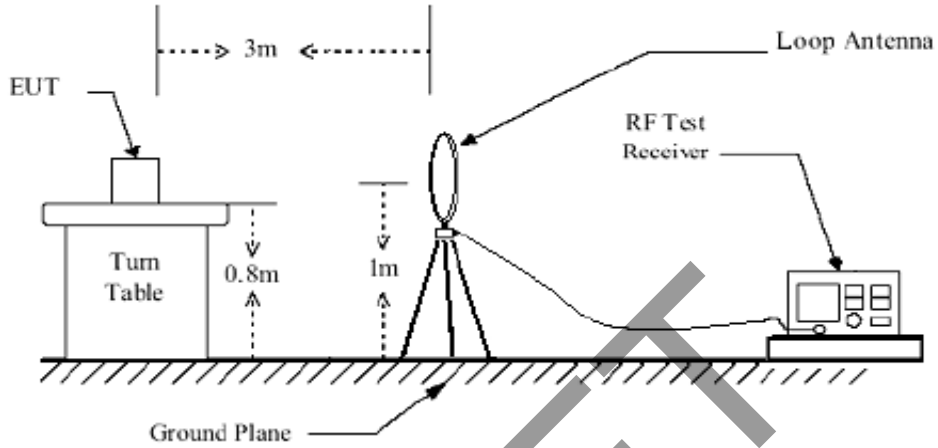

< Frequency Range 30MHz~1GHz >

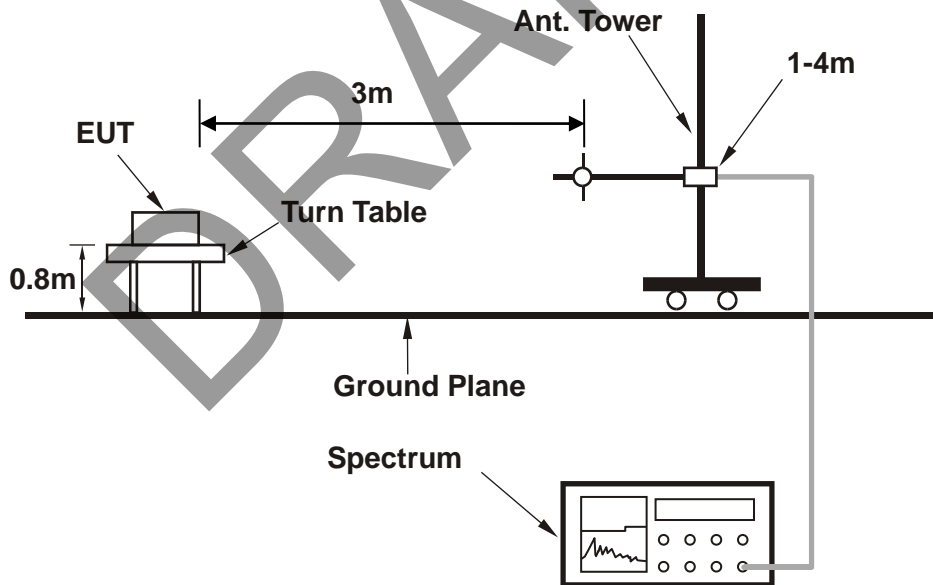



< Frequency Range above 1GHz >

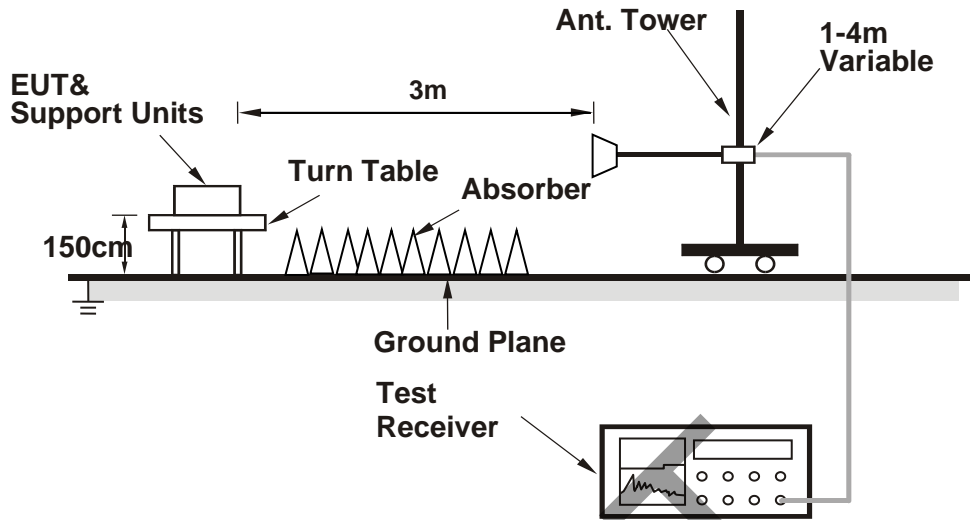

For the actual test configuration, please refer to the attached file (Test Setup Photo).

4.7.5 TEST RESULT

The amplitude of spurious emissions attenuated more than 20 dB below the permissible value is not required in the report.



4.8 PEAK TO AVERAGE RATIO

4.8.1 LIMITS OF PEAK TO AVERAGE RATIO MEASUREMENT

In measuring transmissions in this band using an average power technique, the peak to-average ratio (PAR) of the transmission may not exceed 13 dB

4.8.2 TEST SETUP

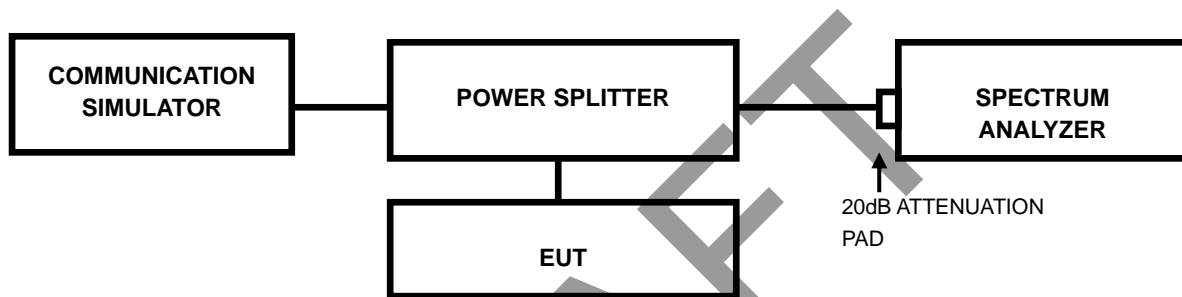

4.8.3 TEST PROCEDURES

1. Set resolution/measurement bandwidth \geq signal's occupied bandwidth;
2. Set the number of counts to a value that stabilizes the measured CCDF curve;
3. Record the maximum PAPR level associated with a probability of 0.1%.



Test Report No.: W7L-P23120015R102

4.8.4 TEST RESULTS

Please Refer to Appendix Of this test report.

DRAFT



Test Report No.: W7L-P23120015R102

5 INFORMATION ON THE TESTING LABORATORIES

We, BV 7Layers Communications Technology (Shenzhen) Co. Ltd, were founded in 2015 to provide our best service in EMC, Radio, and Telecom. Our laboratories are accredited and approved according to ISO/IEC 17025.

If you have any comments, please feel free to contact us at the following:

Shenzhen EMC/RF Lab:

Tel: +86 755 8869 6566

Fax: +86 755 8869 6577

Email: customerservice.sw@cn.bureauveritas.com

Web Site: www.adt.com.tw

The address and road map of all our labs can be found in our web site also.

DRAFT



Test Report No.: W7L-P23120015R102

6 MODIFICATIONS RECORDERS FOR ENGINEERING CHANGES TO THE EUT BY THE LAB

No any modifications are made to the EUT by the lab during the test.

DRAFT



7 APPENDIX

EFFECTIVE (ISOTROPIC) RADIATED POWER OUTPUT DATA FOR M1 GPRS 1900 TEST RESULT

Band	Channel	Slot	Power(dBm)	EIRP(dBm)	EIRP Limit(dBm)	Verdict
GPRS1900	512	1	26.68	31.98	<33	PASS
GPRS1900	512	2	26.49	31.79	<33	PASS
GPRS1900	512	3	26.27	31.57	<33	PASS
GPRS1900	512	4	26.03	31.33	<33	PASS
GPRS1900	661	1	27.21	32.51	<33	PASS
GPRS1900	661	2	27.09	32.39	<33	PASS
GPRS1900	661	3	26.9	32.2	<33	PASS
GPRS1900	661	4	26.69	31.99	<33	PASS
GPRS1900	810	1	27.35	32.65	<33	PASS
GPRS1900	810	2	27.46	32.76	<33	PASS
GPRS1900	810	3	27.27	32.57	<33	PASS
GPRS1900	810	4	27.06	32.36	<33	PASS

Band	Channel	Slot	Power(dBm)	EIRP(dBm)	EIRP Limit(dBm)	Verdict
EGPRS1900	512	1	25.83	31.13	<33	PASS
EGPRS1900	512	2	24.67	29.97	<33	PASS
EGPRS1900	512	3	23.42	28.72	<33	PASS
EGPRS1900	512	4	22.57	27.87	<33	PASS
EGPRS1900	661	1	25.56	30.86	<33	PASS
EGPRS1900	661	2	24.43	29.73	<33	PASS
EGPRS1900	661	3	23.2	28.5	<33	PASS
EGPRS1900	661	4	22.43	27.73	<33	PASS
EGPRS1900	810	1	25.42	30.72	<33	PASS
EGPRS1900	810	2	24.28	29.58	<33	PASS
EGPRS1900	810	3	23.09	28.39	<33	PASS
EGPRS1900	810	4	22.19	27.49	<33	PASS



BAND 2 TEST RESULT

Band	Bandwidth	Modulation	Channel	RB Size	RB Start	NBIndex	Result(dBm)	EIRP(dBm)	EIRP Limit(dBm)	Verdict
Band2	1.4MHz	18607	QPSK	1	0	Low	23.57	28.87	<33	PASS
Band2	1.4MHz	18607	QPSK	1	5	Low	23.2	28.5	<33	PASS
Band2	1.4MHz	18607	QPSK	6	0	Low	22.12	27.42	<33	PASS
Band2	1.4MHz	18900	QPSK	1	0	Low	23.35	28.65	<33	PASS
Band2	1.4MHz	18900	QPSK	1	5	Low	23.16	28.46	<33	PASS
Band2	1.4MHz	18900	QPSK	6	0	Low	21.81	27.11	<33	PASS
Band2	1.4MHz	19193	QPSK	1	0	High	23.11	28.41	<33	PASS
Band2	1.4MHz	19193	QPSK	1	5	High	22.85	28.15	<33	PASS
Band2	1.4MHz	19193	QPSK	6	0	High	22	27.3	<33	PASS
Band2	1.4MHz	18607	16QAM	1	0	Low	23.06	28.36	<33	PASS
Band2	1.4MHz	18607	16QAM	1	5	Low	23.02	28.32	<33	PASS
Band2	1.4MHz	18607	16QAM	6	0	Low	22.11	27.41	<33	PASS
Band2	1.4MHz	18900	16QAM	1	0	Low	23.03	28.33	<33	PASS
Band2	1.4MHz	18900	16QAM	1	5	Low	22.98	28.28	<33	PASS
Band2	1.4MHz	18900	16QAM	6	0	Low	22.07	27.37	<33	PASS
Band2	1.4MHz	19193	16QAM	1	0	High	23.15	28.45	<33	PASS
Band2	1.4MHz	19193	16QAM	1	5	High	23.04	28.34	<33	PASS
Band2	1.4MHz	19193	16QAM	6	0	High	21.98	27.28	<33	PASS
Band2	3MHz	18615	QPSK	1	0	Low	23.2	28.5	<33	PASS
Band2	3MHz	18615	QPSK	1	5	Low	22.95	28.25	<33	PASS
Band2	3MHz	18615	QPSK	6	0	Low	22.72	28.02	<33	PASS
Band2	3MHz	18900	QPSK	1	0	Low	23.23	28.53	<33	PASS
Band2	3MHz	18900	QPSK	1	5	Low	22.99	28.29	<33	PASS
Band2	3MHz	18900	QPSK	6	0	Low	22.24	27.54	<33	PASS
Band2	3MHz	19185	QPSK	1	0	High	23.03	28.33	<33	PASS
Band2	3MHz	19185	QPSK	1	5	High	22.74	28.04	<33	PASS
Band2	3MHz	19185	QPSK	6	0	High	22.23	27.53	<33	PASS
Band2	3MHz	18615	16QAM	1	0	Low	23.41	28.71	<33	PASS
Band2	3MHz	18615	16QAM	1	5	Low	23.25	28.55	<33	PASS
Band2	3MHz	18615	16QAM	6	0	Low	22.63	27.93	<33	PASS
Band2	3MHz	18900	16QAM	1	0	Low	23.01	28.31	<33	PASS
Band2	3MHz	18900	16QAM	1	5	Low	22.76	28.06	<33	PASS
Band2	3MHz	18900	16QAM	6	0	Low	22.4	27.7	<33	PASS
Band2	3MHz	19185	16QAM	1	0	High	23.03	28.33	<33	PASS
Band2	3MHz	19185	16QAM	1	5	High	22.92	28.22	<33	PASS



**BUREAU
VERITAS**

Test Report No.: W7L-P23120015R102

Band2	3MHz	19185	16QAM	6	0	High	22.31	27.61	<33	PASS
Band2	5MHz	18625	QPSK	1	0	Low	23.38	28.68	<33	PASS
Band2	5MHz	18625	QPSK	1	0	3	23.45	28.75	<33	PASS
Band2	5MHz	18625	QPSK	6	0	Low	22.58	27.88	<33	PASS
Band2	5MHz	18900	QPSK	1	0	Low	23.01	28.31	<33	PASS
Band2	5MHz	18900	QPSK	6	0	Low	22.36	27.66	<33	PASS
Band2	5MHz	19175	QPSK	1	5	High	22.69	27.99	<33	PASS
Band2	5MHz	19175	QPSK	1	5	0	22.84	28.14	<33	PASS
Band2	5MHz	19175	QPSK	6	0	High	22.25	27.55	<33	PASS
Band2	5MHz	18625	16QAM	1	0	Low	23.17	28.47	<33	PASS
Band2	5MHz	18625	16QAM	1	0	3	23.41	28.71	<33	PASS
Band2	5MHz	18625	16QAM	6	0	Low	22.57	27.87	<33	PASS
Band2	5MHz	18900	16QAM	1	0	Low	23.12	28.42	<33	PASS
Band2	5MHz	18900	16QAM	6	0	Low	22.38	27.68	<33	PASS
Band2	5MHz	19175	16QAM	1	5	High	23	28.3	<33	PASS
Band2	5MHz	19175	16QAM	1	5	0	23.04	28.34	<33	PASS
Band2	5MHz	19175	16QAM	6	0	High	22.24	27.54	<33	PASS
Band2	10MHz	18650	QPSK	1	0	Low	23.18	28.48	<33	PASS
Band2	10MHz	18650	QPSK	1	0	3	23.35	28.65	<33	PASS
Band2	10MHz	18650	QPSK	4	0	Low	23.14	28.44	<33	PASS
Band2	10MHz	18900	QPSK	1	0	Low	23.04	28.34	<33	PASS
Band2	10MHz	18900	QPSK	4	0	Low	22.78	28.08	<33	PASS
Band2	10MHz	19150	QPSK	1	5	High	22.93	28.23	<33	PASS
Band2	10MHz	19150	QPSK	1	5	4	23.15	28.45	<33	PASS
Band2	10MHz	19150	QPSK	4	2	High	22.76	28.06	<33	PASS
Band2	10MHz	18650	16QAM	1	0	Low	23.3	28.6	<33	PASS
Band2	10MHz	18650	16QAM	1	0	3	23.51	28.81	<33	PASS
Band2	10MHz	18650	16QAM	4	0	Low	23.17	28.47	<33	PASS
Band2	10MHz	18900	16QAM	1	0	Low	23.05	28.35	<33	PASS
Band2	10MHz	18900	16QAM	4	0	Low	22.77	28.07	<33	PASS
Band2	10MHz	19150	16QAM	1	5	High	23.05	28.35	<33	PASS
Band2	10MHz	19150	16QAM	1	5	4	22.99	28.29	<33	PASS
Band2	10MHz	19150	16QAM	4	2	High	22.9	28.2	<33	PASS
Band2	15MHz	18675	QPSK	1	0	Low	23.16	28.46	<33	PASS
Band2	15MHz	18675	QPSK	1	0	3	23.41	28.71	<33	PASS
Band2	15MHz	18675	QPSK	6	0	Low	22.94	28.24	<33	PASS
Band2	15MHz	18900	QPSK	1	0	Low	22.98	28.28	<33	PASS
Band2	15MHz	18900	QPSK	6	0	Low	22.83	28.13	<33	PASS



Band2	15MHz	19125	QPSK	1	5	High	22.89	28.19	<33	PASS
Band2	15MHz	19125	QPSK	1	5	8	23.16	28.46	<33	PASS
Band2	15MHz	19125	QPSK	6	0	High	22.83	28.13	<33	PASS
Band2	15MHz	18675	16QAM	1	0	Low	23.25	28.55	<33	PASS
Band2	15MHz	18675	16QAM	1	0	3	23.35	28.65	<33	PASS
Band2	15MHz	18675	16QAM	6	0	Low	22.96	28.26	<33	PASS
Band2	15MHz	18900	16QAM	1	0	Low	23.15	28.45	<33	PASS
Band2	15MHz	18900	16QAM	6	0	Low	22.83	28.13	<33	PASS
Band2	15MHz	19125	16QAM	1	5	High	23.04	28.34	<33	PASS
Band2	15MHz	19125	16QAM	1	5	8	22.97	28.27	<33	PASS
Band2	15MHz	19125	16QAM	6	0	High	22.71	28.01	<33	PASS
Band2	20MHz	18700	QPSK	1	0	Low	23.39	28.69	<33	PASS
Band2	20MHz	18700	QPSK	1	0	3	23.3	28.6	<33	PASS
Band2	20MHz	18700	QPSK	6	0	Low	23	28.3	<33	PASS
Band2	20MHz	18900	QPSK	1	0	Low	23.15	28.45	<33	PASS
Band2	20MHz	18900	QPSK	6	0	Low	22.79	28.09	<33	PASS
Band2	20MHz	19100	QPSK	1	5	High	22.9	28.2	<33	PASS
Band2	20MHz	19100	QPSK	1	5	12	23.16	28.46	<33	PASS
Band2	20MHz	19100	QPSK	6	0	High	22.79	28.09	<33	PASS
Band2	20MHz	18700	16QAM	1	0	Low	23.32	28.62	<33	PASS
Band2	20MHz	18700	16QAM	1	0	3	23.27	28.57	<33	PASS
Band2	20MHz	18700	16QAM	6	0	Low	23.21	28.51	<33	PASS
Band2	20MHz	18900	16QAM	1	0	Low	23.11	28.41	<33	PASS
Band2	20MHz	18900	16QAM	6	0	Low	22.84	28.14	<33	PASS
Band2	20MHz	19100	16QAM	1	5	High	23.02	28.32	<33	PASS
Band2	20MHz	19100	16QAM	1	5	12	23.03	28.33	<33	PASS
Band2	20MHz	19100	16QAM	6	0	High	22.81	28.11	<33	PASS



BAND 25 TEST RESULT

Band	Bandwidth	Modulation	Channel	RB Size	RB Start	NBIndex	Result(dBm)	EIRP(dBm)	EIRP Limit(dBm)	Verdict
Band25	1.4MHz	26047	QPSK	1	0	Low	22.72	28.02	<33	PASS
Band25	1.4MHz	26047	QPSK	1	5	Low	22.21	27.51	<33	PASS
Band25	1.4MHz	26047	QPSK	6	0	Low	21.11	26.41	<33	PASS
Band25	1.4MHz	26365	QPSK	1	0	Low	22.65	27.95	<33	PASS
Band25	1.4MHz	26365	QPSK	1	5	Low	22.16	27.46	<33	PASS
Band25	1.4MHz	26365	QPSK	6	0	Low	21.07	26.37	<33	PASS
Band25	1.4MHz	26683	QPSK	1	0	High	22.14	27.44	<33	PASS
Band25	1.4MHz	26683	QPSK	1	5	High	21.81	27.11	<33	PASS
Band25	1.4MHz	26683	QPSK	6	0	High	20.81	26.11	<33	PASS
Band25	1.4MHz	26047	16QAM	1	0	Low	22.37	27.67	<33	PASS
Band25	1.4MHz	26047	16QAM	1	5	Low	22.33	27.63	<33	PASS
Band25	1.4MHz	26047	16QAM	6	0	Low	21.19	26.49	<33	PASS
Band25	1.4MHz	26365	16QAM	1	0	Low	22.23	27.53	<33	PASS
Band25	1.4MHz	26365	16QAM	1	5	Low	22.1	27.4	<33	PASS
Band25	1.4MHz	26365	16QAM	6	0	Low	21.07	26.37	<33	PASS
Band25	1.4MHz	26683	16QAM	1	0	High	22.07	27.37	<33	PASS
Band25	1.4MHz	26683	16QAM	1	5	High	21.98	27.28	<33	PASS
Band25	1.4MHz	26683	16QAM	6	0	High	20.89	26.19	<33	PASS
Band25	3MHz	26055	QPSK	1	0	Low	22.3	27.6	<33	PASS
Band25	3MHz	26055	QPSK	1	5	Low	22.25	27.55	<33	PASS
Band25	3MHz	26055	QPSK	6	0	Low	21.88	27.18	<33	PASS
Band25	3MHz	26365	QPSK	1	0	Low	22.69	27.99	<33	PASS
Band25	3MHz	26365	QPSK	1	5	Low	22.27	27.57	<33	PASS
Band25	3MHz	26365	QPSK	6	0	Low	21.61	26.91	<33	PASS
Band25	3MHz	26675	QPSK	1	0	High	22.11	27.41	<33	PASS
Band25	3MHz	26675	QPSK	1	5	High	21.59	26.89	<33	PASS
Band25	3MHz	26675	QPSK	6	0	High	21.37	26.67	<33	PASS
Band25	3MHz	26055	16QAM	1	0	Low	22.55	27.85	<33	PASS
Band25	3MHz	26055	16QAM	1	5	Low	22.44	27.74	<33	PASS
Band25	3MHz	26055	16QAM	6	0	Low	21.88	27.18	<33	PASS
Band25	3MHz	26365	16QAM	1	0	Low	22.26	27.56	<33	PASS
Band25	3MHz	26365	16QAM	1	5	Low	22.15	27.45	<33	PASS
Band25	3MHz	26365	16QAM	6	0	Low	21.71	27.01	<33	PASS
Band25	3MHz	26675	16QAM	1	0	High	22.05	27.35	<33	PASS
Band25	3MHz	26675	16QAM	1	5	High	22.02	27.32	<33	PASS
Band25	3MHz	26675	16QAM	6	0	High	21.4	26.7	<33	PASS
Band25	5MHz	26065	QPSK	1	0	Low	22.49	27.79	<33	PASS
Band25	5MHz	26065	QPSK	1	0	3	22.78	28.08	<33	PASS



BUREAU
VERITAS

Test Report No.: W7L-P23120015R102

Band25	5MHz	26065	QPSK	1	5	Low	22.23	27.53	<33	PASS
Band25	5MHz	26065	QPSK	6	0	Low	21.74	27.04	<33	PASS
Band25	5MHz	26365	QPSK	1	0	Low	22.41	27.71	<33	PASS
Band25	5MHz	26365	QPSK	1	5	Low	22.26	27.56	<33	PASS
Band25	5MHz	26365	QPSK	6	0	Low	21.63	26.93	<33	PASS
Band25	5MHz	26665	QPSK	1	0	High	22.16	27.46	<33	PASS
Band25	5MHz	26665	QPSK	1	5	High	21.91	27.21	<33	PASS
Band25	5MHz	26665	QPSK	6	0	High	21.34	26.64	<33	PASS
Band25	5MHz	26665	QPSK	6	0	3	21.67	26.97	<33	PASS
Band25	5MHz	26065	16QAM	1	0	Low	22.55	27.85	<33	PASS
Band25	5MHz	26065	16QAM	1	0	3	22.91	28.21	<33	PASS
Band25	5MHz	26065	16QAM	1	5	Low	22.3	27.6	<33	PASS
Band25	5MHz	26065	16QAM	6	0	Low	21.74	27.04	<33	PASS
Band25	5MHz	26365	16QAM	1	0	Low	22.38	27.68	<33	PASS
Band25	5MHz	26365	16QAM	1	5	Low	22.2	27.5	<33	PASS
Band25	5MHz	26365	16QAM	6	0	Low	21.72	27.02	<33	PASS
Band25	5MHz	26665	16QAM	1	0	High	22.31	27.61	<33	PASS
Band25	5MHz	26665	16QAM	1	5	High	22.04	27.34	<33	PASS
Band25	5MHz	26665	16QAM	6	0	High	21.34	26.64	<33	PASS
Band25	5MHz	26665	16QAM	6	0	3	21.73	27.03	<33	PASS
Band25	10MHz	26090	QPSK	1	0	Low	22.47	27.77	<33	PASS
Band25	10MHz	26090	QPSK	1	0	3	22.68	27.98	<33	PASS
Band25	10MHz	26090	QPSK	1	5	Low	22.41	27.71	<33	PASS
Band25	10MHz	26090	QPSK	4	0	Low	22.25	27.55	<33	PASS
Band25	10MHz	26090	QPSK	6	0	Low	22.21	27.51	<33	PASS
Band25	10MHz	26365	QPSK	1	0	Low	22.47	27.77	<33	PASS
Band25	10MHz	26365	QPSK	1	5	Low	22.21	27.51	<33	PASS
Band25	10MHz	26365	QPSK	4	0	Low	22.16	27.46	<33	PASS
Band25	10MHz	26365	QPSK	6	0	Low	22.07	27.37	<33	PASS
Band25	10MHz	26640	QPSK	1	0	High	22.06	27.36	<33	PASS
Band25	10MHz	26640	QPSK	1	5	High	21.92	27.22	<33	PASS
Band25	10MHz	26640	QPSK	1	5	4	22.43	27.73	<33	PASS
Band25	10MHz	26640	QPSK	4	2	High	21.84	27.14	<33	PASS
Band25	10MHz	26640	QPSK	6	0	High	21.82	27.12	<33	PASS
Band25	10MHz	26090	16QAM	1	0	Low	22.65	27.95	<33	PASS
Band25	10MHz	26090	16QAM	1	0	3	22.88	28.18	<33	PASS
Band25	10MHz	26090	16QAM	1	5	Low	22.43	27.73	<33	PASS
Band25	10MHz	26090	16QAM	4	0	Low	22.53	27.83	<33	PASS
Band25	10MHz	26090	16QAM	6	0	Low	22.3	27.6	<33	PASS
Band25	10MHz	26365	16QAM	1	0	Low	22.41	27.71	<33	PASS
Band25	10MHz	26365	16QAM	1	5	Low	22.23	27.53	<33	PASS
Band25	10MHz	26365	16QAM	4	0	Low	22.13	27.43	<33	PASS
Band25	10MHz	26365	16QAM	6	0	Low	22.11	27.41	<33	PASS

BV 7Layers Communications Technology
(Shenzhen) Co., Ltd

Room B37, Warehouse A5, No.3 Chiwan 4th Road,
Zhaoshang Street, Nanshan District Shenzhen,
Guangdong, People's Republic of China

Tel: +86 755 8869 6566
Fax: +86 755 8869 6577
Email: customerservice.sw@bureauveritas.com



**BUREAU
VERITAS**

Test Report No.: W7L-P23120015R102

Band25	10MHz	26640	16QAM	1	0	High	22.27	27.57	<33	PASS
Band25	10MHz	26640	16QAM	1	5	High	22.03	27.33	<33	PASS
Band25	10MHz	26640	16QAM	1	5	4	22.31	27.61	<33	PASS
Band25	10MHz	26640	16QAM	4	2	High	22.05	27.35	<33	PASS
Band25	10MHz	26640	16QAM	6	0	High	21.83	27.13	<33	PASS
Band25	15MHz	26115	QPSK	1	0	Low	22.45	27.75	<33	PASS
Band25	15MHz	26115	QPSK	1	0	3	22.7	28	<33	PASS
Band25	15MHz	26115	QPSK	1	5	Low	22.21	27.51	<33	PASS
Band25	15MHz	26115	QPSK	6	0	Low	22.28	27.58	<33	PASS
Band25	15MHz	26365	QPSK	1	0	Low	22.48	27.78	<33	PASS
Band25	15MHz	26365	QPSK	1	5	Low	22.28	27.58	<33	PASS
Band25	15MHz	26365	QPSK	6	0	Low	22.14	27.44	<33	PASS
Band25	15MHz	26615	QPSK	1	0	High	22.27	27.57	<33	PASS
Band25	15MHz	26615	QPSK	1	5	High	21.94	27.24	<33	PASS
Band25	15MHz	26615	QPSK	1	5	8	22.48	27.78	<33	PASS
Band25	15MHz	26615	QPSK	6	0	High	21.85	27.15	<33	PASS
Band25	15MHz	26115	16QAM	1	0	Low	22.57	27.87	<33	PASS
Band25	15MHz	26115	16QAM	1	0	3	22.91	28.21	<33	PASS
Band25	15MHz	26115	16QAM	1	5	Low	22.4	27.7	<33	PASS
Band25	15MHz	26115	16QAM	6	0	Low	22.31	27.61	<33	PASS
Band25	15MHz	26365	16QAM	1	0	Low	22.52	27.82	<33	PASS
Band25	15MHz	26365	16QAM	1	5	Low	22.28	27.58	<33	PASS
Band25	15MHz	26365	16QAM	6	0	Low	22.27	27.57	<33	PASS
Band25	15MHz	26615	16QAM	1	0	High	22.19	27.49	<33	PASS
Band25	15MHz	26615	16QAM	1	5	High	22.05	27.35	<33	PASS
Band25	15MHz	26615	16QAM	1	5	8	22.36	27.66	<33	PASS
Band25	15MHz	26615	16QAM	6	0	High	21.93	27.23	<33	PASS
Band25	20MHz	26140	QPSK	1	0	Low	22.54	27.84	<33	PASS
Band25	20MHz	26140	QPSK	1	0	3	22.66	27.96	<33	PASS
Band25	20MHz	26140	QPSK	1	5	Low	22.19	27.49	<33	PASS
Band25	20MHz	26140	QPSK	6	0	Low	22.23	27.53	<33	PASS
Band25	20MHz	26365	QPSK	1	0	Low	22.44	27.74	<33	PASS
Band25	20MHz	26365	QPSK	1	5	Low	22.23	27.53	<33	PASS
Band25	20MHz	26365	QPSK	6	0	Low	22.12	27.42	<33	PASS
Band25	20MHz	26590	QPSK	1	0	High	22.22	27.52	<33	PASS
Band25	20MHz	26590	QPSK	1	5	High	21.98	27.28	<33	PASS
Band25	20MHz	26590	QPSK	1	5	15	22.46	27.76	<33	PASS
Band25	20MHz	26590	QPSK	6	0	High	21.88	27.18	<33	PASS
Band25	20MHz	26140	16QAM	1	0	Low	22.57	27.87	<33	PASS
Band25	20MHz	26140	16QAM	1	0	3	22.82	28.12	<33	PASS
Band25	20MHz	26140	16QAM	1	5	Low	22.42	27.72	<33	PASS
Band25	20MHz	26140	16QAM	6	0	Low	22.28	27.58	<33	PASS
Band25	20MHz	26365	16QAM	1	0	Low	22.46	27.76	<33	PASS

BV 7Layers Communications Technology
(Shenzhen) Co., Ltd

Room B37, Warehouse A5, No.3 Chiwan 4th Road,
Zhaoshang Street, Nanshan District Shenzhen,
Guangdong, People's Republic of China

Tel: +86 755 8869 6566
Fax: +86 755 8869 6577
Email: customerservice.sw@bureauveritas.com



**BUREAU
VERITAS**

Test Report No.: W7L-P23120015R102

Band25	20MHz	26365	16QAM	1	5	Low	22.26	27.56	<33	PASS
Band25	20MHz	26365	16QAM	6	0	Low	22.14	27.44	<33	PASS
Band25	20MHz	26590	16QAM	1	0	High	22.29	27.59	<33	PASS
Band25	20MHz	26590	16QAM	1	5	High	22.13	27.43	<33	PASS
Band25	20MHz	26590	16QAM	1	5	15	22.25	27.55	<33	PASS
Band25	20MHz	26590	16QAM	6	0	High	21.89	27.19	<33	PASS

DRAFT



PEAK-TO-AVERAGE RATIO(CCDF) FOR M1 GPRS 1900 TEST RESULT

Band	Channel	Result(dB)	Limit(dB)	Verdict
GPRS1900	512	9.77	13	PASS
GPRS1900	661	9.42	13	PASS
GPRS1900	810	9.77	13	PASS
EGPRS1900	512	12.12	13	PASS
EGPRS1900	661	12.14	13	PASS
EGPRS1900	810	12.03	13	PASS

GPRS 1900 TEST GRAPHS

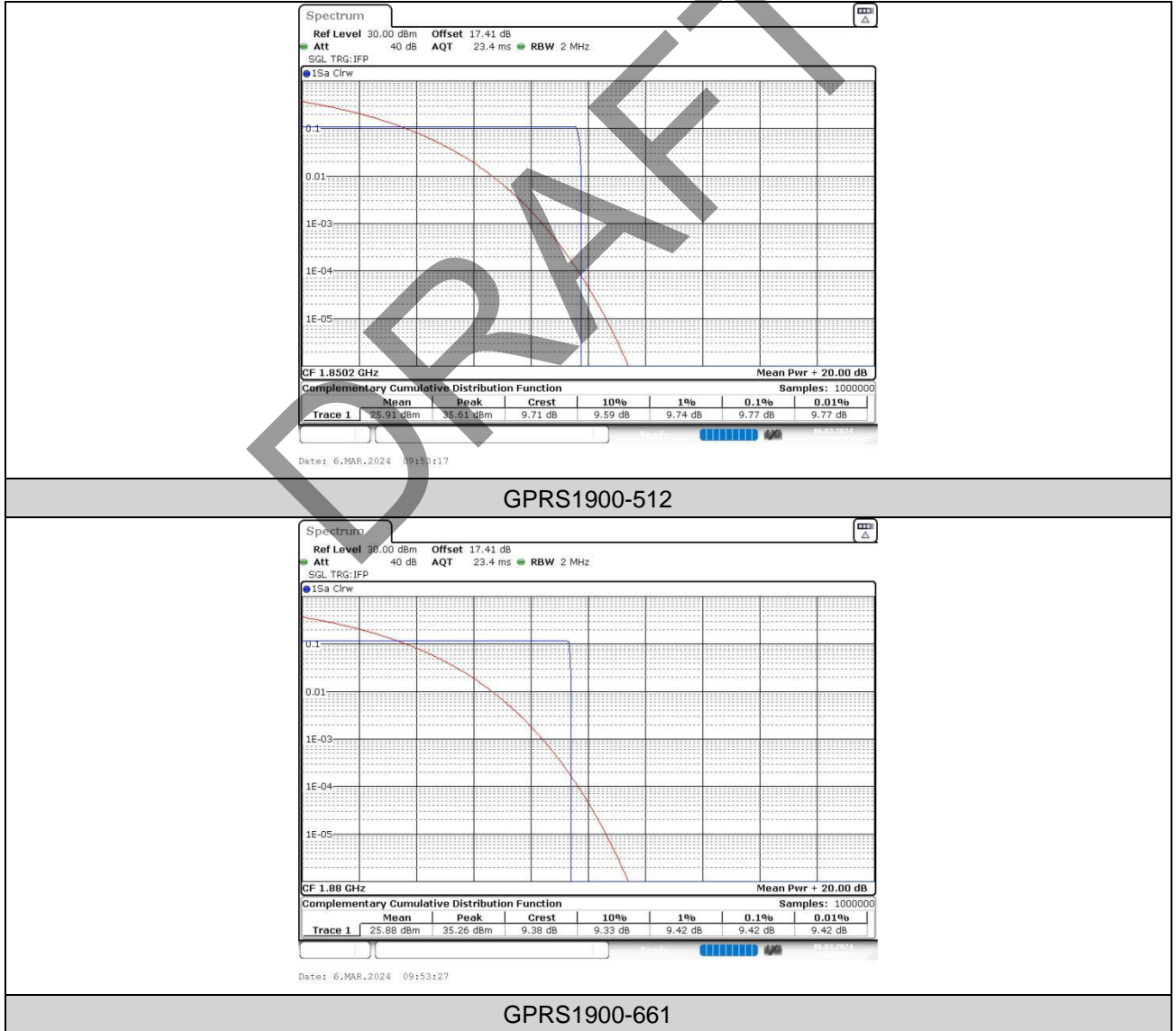



BUREAU VERITAS

Test Report No.: W7L-P23120015R102

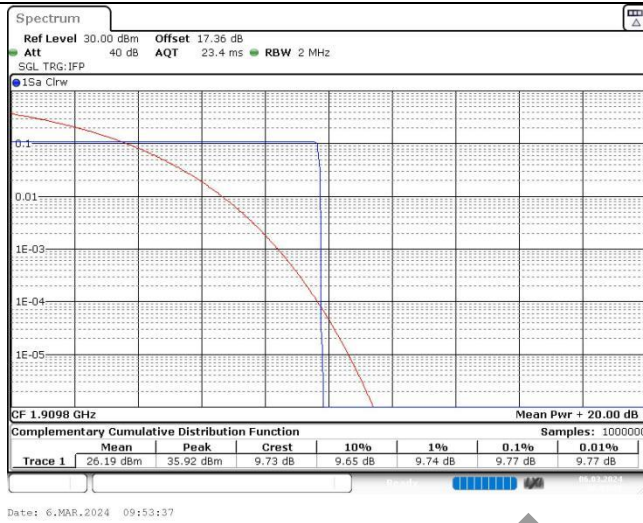

GPRS1900-810

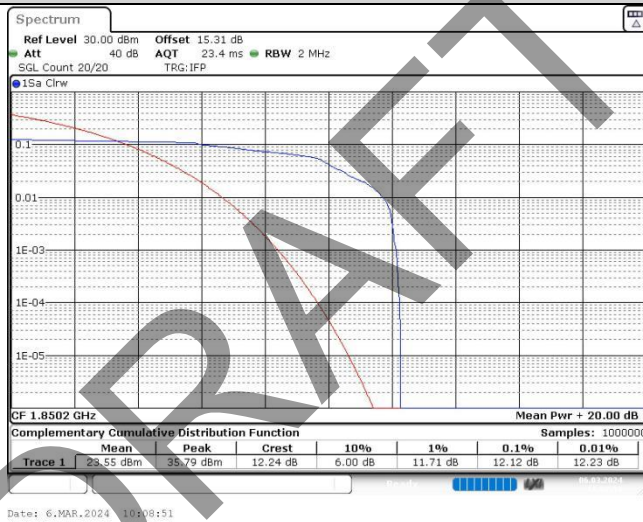

EGPRS1900-512

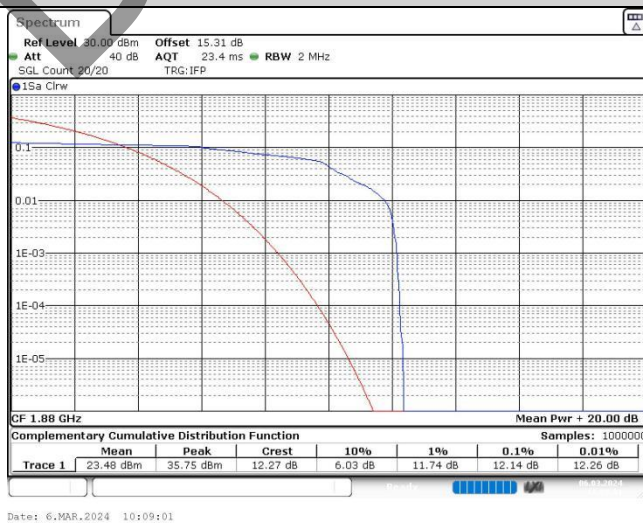

EGPRS1900-661



**BUREAU
VERITAS**

Test Report No.: W7L-P23120015R102

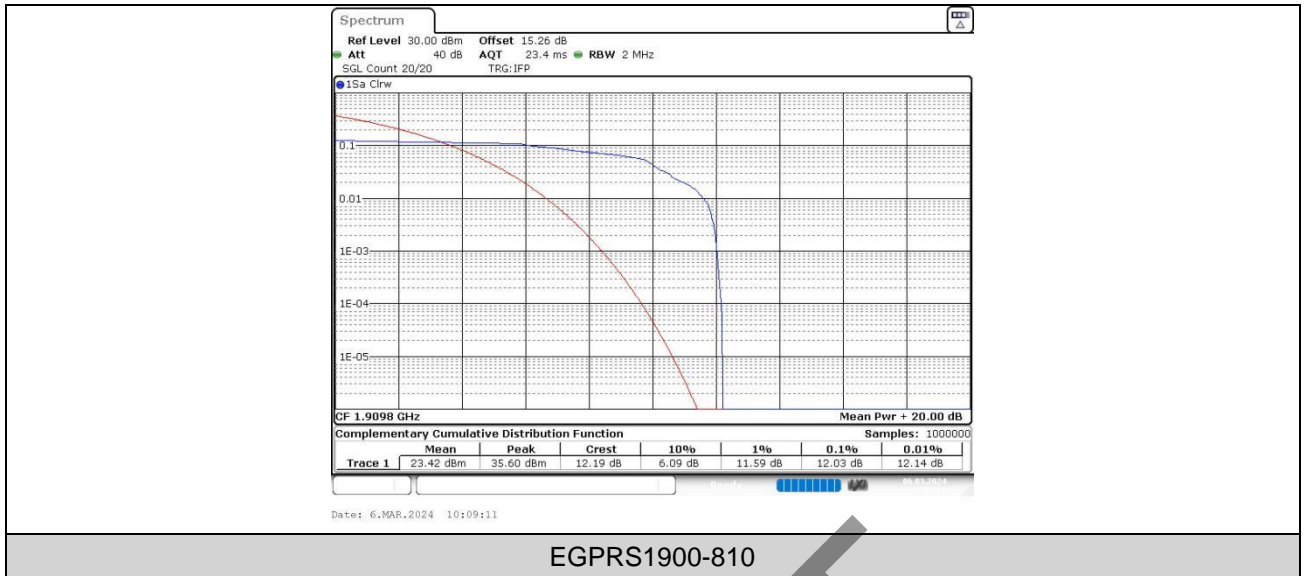

EGPRS1900-810

BAND 2 TEST RESULT

Band	Bandwidth	Modulation	Channel	RB Size	RB Start	NBIndex	Result(dB)	Limit(dB)	Verdict
Band2	1.4MHz	18607	QPSK	1	0	Low	4.17	<=13	PASS
Band2	1.4MHz	18607	QPSK	6	0	Low	11.13	<=13	PASS
Band2	1.4MHz	18900	QPSK	1	0	Low	9.86	<=13	PASS
Band2	1.4MHz	18900	QPSK	6	0	Low	9.88	<=13	PASS
Band2	1.4MHz	19193	QPSK	1	0	High	9.80	<=13	PASS
Band2	1.4MHz	19193	QPSK	6	0	High	10.49	<=13	PASS
Band2	1.4MHz	18607	16QAM	1	0	Low	10.41	<=13	PASS
Band2	1.4MHz	18607	16QAM	6	0	Low	8.49	<=13	PASS
Band2	1.4MHz	18900	16QAM	1	0	Low	7.25	<=13	PASS
Band2	1.4MHz	18900	16QAM	6	0	Low	9.13	<=13	PASS
Band2	1.4MHz	19193	16QAM	1	0	High	9.80	<=13	PASS
Band2	1.4MHz	19193	16QAM	6	0	High	9.54	<=13	PASS
Band2	3MHz	18615	QPSK	1	0	Low	3.10	<=13	PASS
Band2	3MHz	18615	QPSK	6	0	Low	7.97	<=13	PASS
Band2	3MHz	18900	QPSK	1	0	Low	7.74	<=13	PASS
Band2	3MHz	18900	QPSK	6	0	Low	10.90	<=13	PASS
Band2	3MHz	19185	QPSK	1	0	High	7.01	<=13	PASS
Band2	3MHz	19185	QPSK	6	0	High	10.32	<=13	PASS
Band2	3MHz	18615	16QAM	1	0	Low	7.19	<=13	PASS
Band2	3MHz	18615	16QAM	6	0	Low	8.00	<=13	PASS
Band2	3MHz	18900	16QAM	1	0	Low	7.39	<=13	PASS
Band2	3MHz	18900	16QAM	6	0	Low	10.90	<=13	PASS
Band2	3MHz	19185	16QAM	1	0	High	8.70	<=13	PASS
Band2	3MHz	19185	16QAM	6	0	High	7.71	<=13	PASS
Band2	5MHz	18625	QPSK	1	0	Low	3.54	<=13	PASS
Band2	5MHz	18625	QPSK	6	0	Low	9.01	<=13	PASS
Band2	5MHz	18900	QPSK	1	0	Low	8.55	<=13	PASS
Band2	5MHz	18900	QPSK	6	0	Low	8.52	<=13	PASS
Band2	5MHz	19175	QPSK	1	0	High	6.84	<=13	PASS

BV 7Layers Communications Technology
(Shenzhen) Co., Ltd

Room B37, Warehouse A5, No.3 Chiwan 4th Road,
Zhaoshang Street, Nanshan District Shenzhen,
Guangdong, People's Republic of China

Tel: +86 755 8869 6566

Fax: +86 755 8869 6577

Email: customerservice.sw@bureauveritas.com



Band2	5MHz	19175	QPSK	6	0	High	7.62	<=13	PASS
Band2	5MHz	18625	16QAM	1	0	Low	9.39	<=13	PASS
Band2	5MHz	18625	16QAM	6	0	Low	10.87	<=13	PASS
Band2	5MHz	18900	16QAM	1	0	Low	7.36	<=13	PASS
Band2	5MHz	18900	16QAM	6	0	Low	7.88	<=13	PASS
Band2	5MHz	19175	16QAM	1	0	High	7.04	<=13	PASS
Band2	5MHz	19175	16QAM	6	0	High	7.62	<=13	PASS
Band2	10MHz	18650	QPSK	1	0	Low	8.41	<=13	PASS
Band2	10MHz	18650	QPSK	6	0	Low	7.94	<=13	PASS
Band2	10MHz	18900	QPSK	1	0	Low	10.17	<=13	PASS
Band2	10MHz	18900	QPSK	6	0	Low	7.54	<=13	PASS
Band2	10MHz	19150	QPSK	1	0	High	9.83	<=13	PASS
Band2	10MHz	19150	QPSK	6	0	High	9.33	<=13	PASS
Band2	10MHz	18650	16QAM	1	0	Low	9.10	<=13	PASS
Band2	10MHz	18650	16QAM	6	0	Low	8.70	<=13	PASS
Band2	10MHz	18900	16QAM	1	0	Low	10.35	<=13	PASS
Band2	10MHz	18900	16QAM	6	0	Low	8.12	<=13	PASS
Band2	10MHz	19150	16QAM	1	0	High	9.88	<=13	PASS
Band2	10MHz	19150	16QAM	6	0	High	9.91	<=13	PASS
Band2	15MHz	18675	QPSK	1	0	Low	8.38	<=13	PASS
Band2	15MHz	18675	QPSK	6	0	Low	10.26	<=13	PASS
Band2	15MHz	18900	QPSK	1	0	Low	8.70	<=13	PASS
Band2	15MHz	18900	QPSK	6	0	Low	8.70	<=13	PASS
Band2	15MHz	19125	QPSK	1	0	High	6.87	<=13	PASS
Band2	15MHz	19125	QPSK	6	0	High	8.93	<=13	PASS
Band2	15MHz	18675	16QAM	1	0	Low	7.10	<=13	PASS
Band2	15MHz	18675	16QAM	6	0	Low	10.46	<=13	PASS
Band2	15MHz	18900	16QAM	1	0	Low	7.80	<=13	PASS
Band2	15MHz	18900	16QAM	6	0	Low	7.74	<=13	PASS
Band2	15MHz	19125	16QAM	1	0	High	6.87	<=13	PASS
Band2	15MHz	19125	16QAM	6	0	High	7.30	<=13	PASS
Band2	20MHz	18700	QPSK	1	0	Low	8.58	<=13	PASS
Band2	20MHz	18700	QPSK	6	0	Low	7.77	<=13	PASS
Band2	20MHz	18900	QPSK	1	0	Low	7.36	<=13	PASS
Band2	20MHz	18900	QPSK	6	0	Low	7.86	<=13	PASS
Band2	20MHz	19100	QPSK	1	0	High	6.93	<=13	PASS
Band2	20MHz	19100	QPSK	6	0	High	7.39	<=13	PASS
Band2	20MHz	18700	16QAM	1	0	Low	7.94	<=13	PASS
Band2	20MHz	18700	16QAM	6	0	Low	7.83	<=13	PASS
Band2	20MHz	18900	16QAM	1	0	Low	7.45	<=13	PASS
Band2	20MHz	18900	16QAM	6	0	Low	7.91	<=13	PASS
Band2	20MHz	19100	16QAM	1	0	High	7.25	<=13	PASS
Band2	20MHz	19100	16QAM	6	0	High	7.39	<=13	PASS



BUREAU VERITAS

Test Report No.: W7L-P23120015R102

BAND 2 TEST GRAPHS

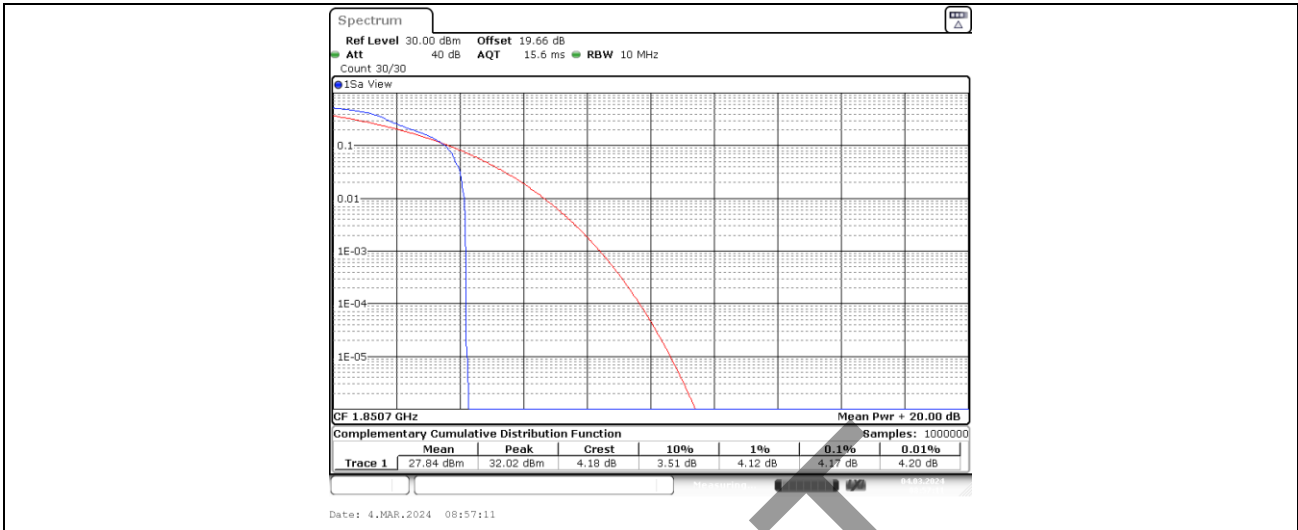

Band2-1.4MHz-QPSK-18607-1-0-Low-4.17-<=13-PASS

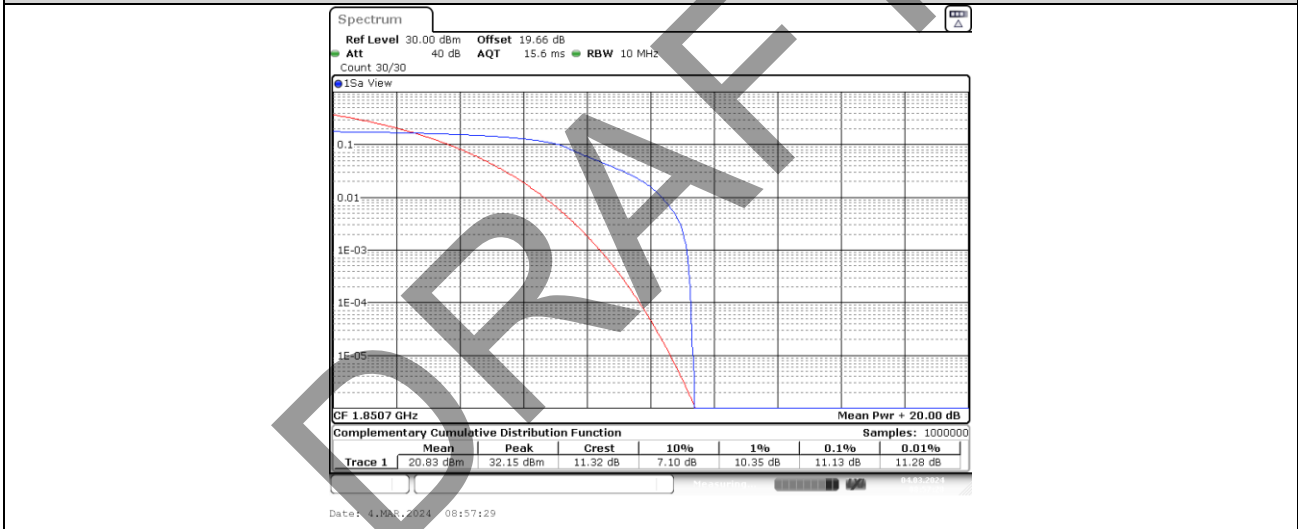

Band2-1.4MHz-QPSK-18607-6-0-Low-11.13-<=13-PASS



BUREAU VERITAS

Test Report No.: W7L-P23120015R102

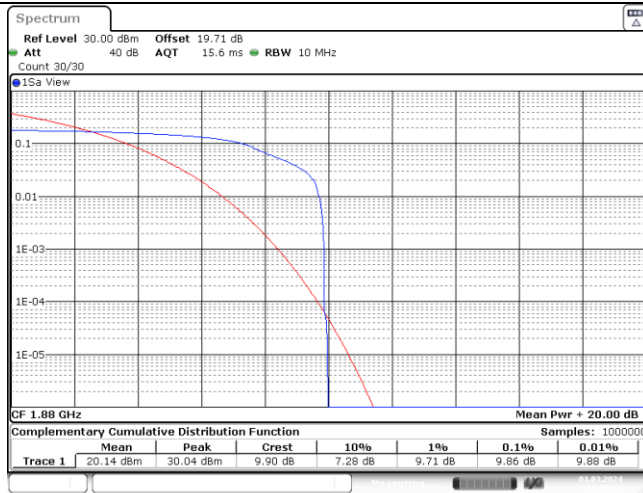

Band2-1.4MHz-QPSK-18900-1-0-Low-9.86-<=13-PASS

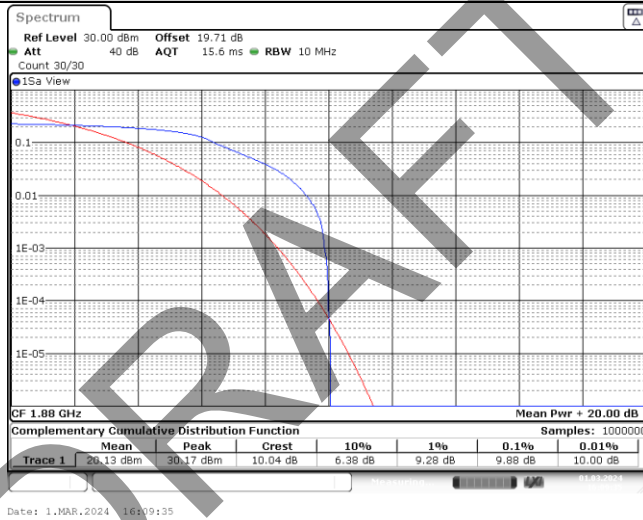

Band2-1.4MHz-QPSK-18900-6-0-Low-9.88-<=13-PASS

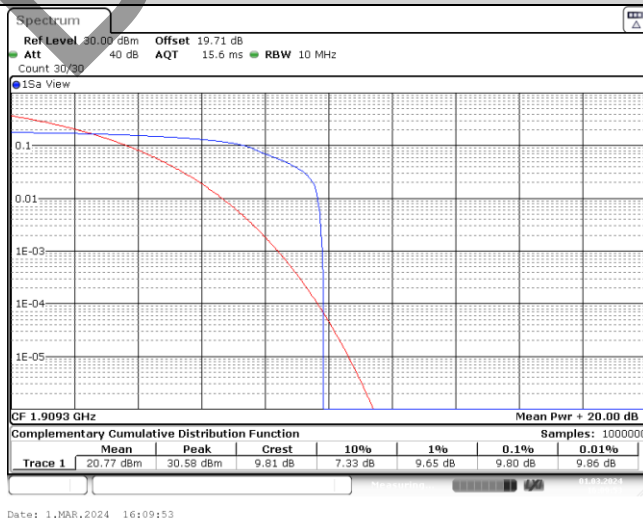

Band2-1.4MHz-QPSK-19193-1-0-High-9.80-<=13-PASS



BUREAU VERITAS

Test Report No.: W7L-P23120015R102

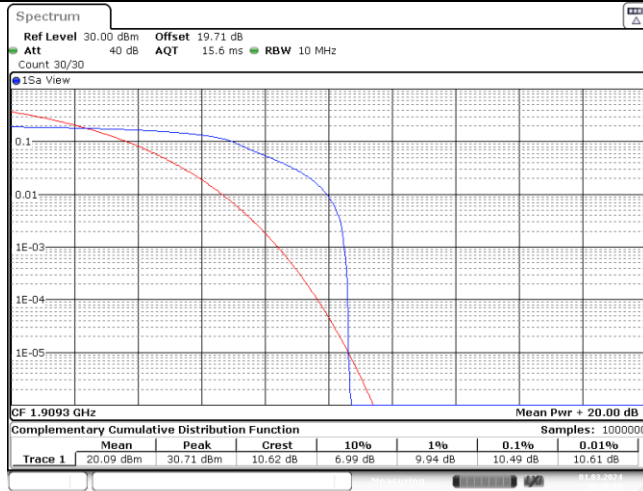

Date: 1.MAR.2024 16:10:10

Band2-1.4MHz-QPSK-19193-6-0-High-10.49-<=13-PASS

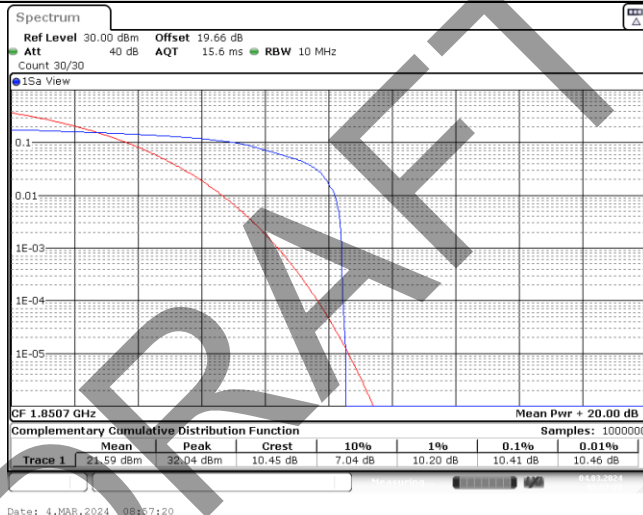

Date: 4.MAR.2024 08:57:20

Band2-1.4MHz-16QAM-18607-1-0-Low-10.41-<=13-PASS

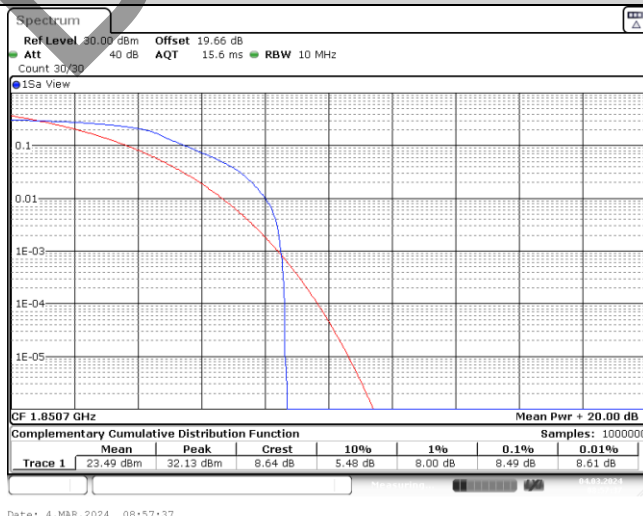

Date: 4.MAR.2024 08:57:37

Band2-1.4MHz-16QAM-18607-6-0-Low-8.49-<=13-PASS



BUREAU VERITAS

Test Report No.: W7L-P23120015R102

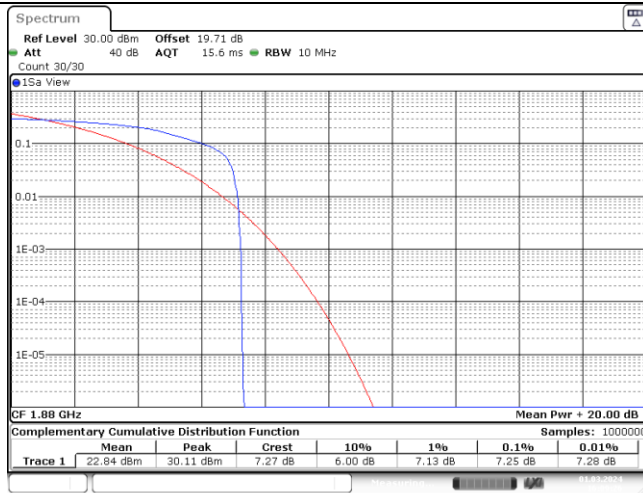

Date: 1.MAR.2024 16:09:26

Band2-1.4MHz-16QAM-18900-1-0-Low-7.25-<=13-PASS

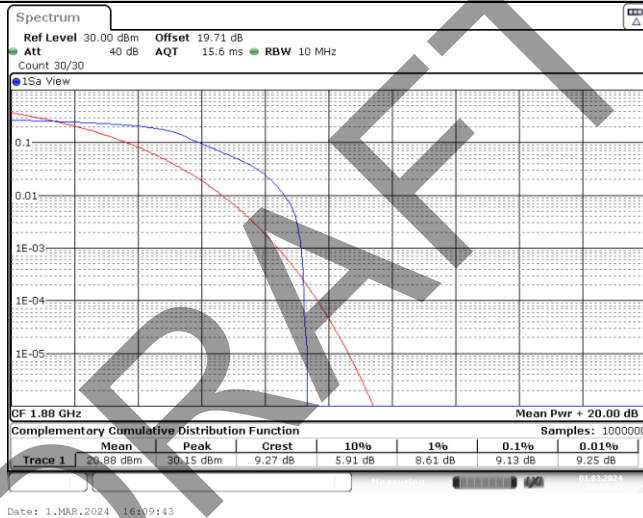

Date: 1.MAR.2024 16:09:43

Band2-1.4MHz-16QAM-18900-6-0-Low-9.13-<=13-PASS

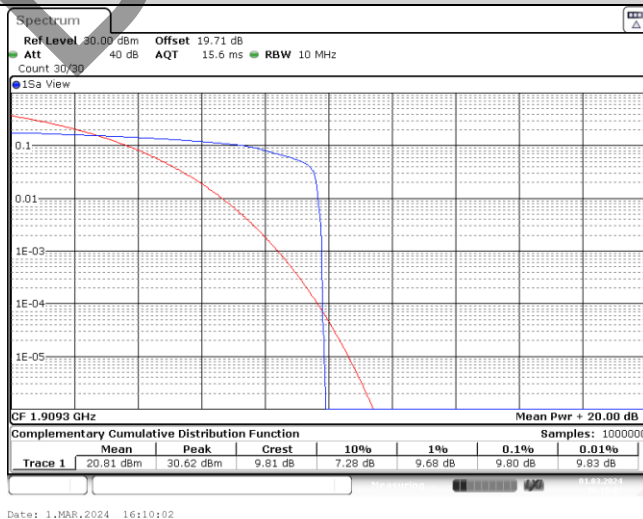

Date: 1.MAR.2024 16:10:02

Band2-1.4MHz-16QAM-19193-1-0-High-9.80-<=13-PASS



BUREAU VERITAS

Test Report No.: W7L-P23120015R102

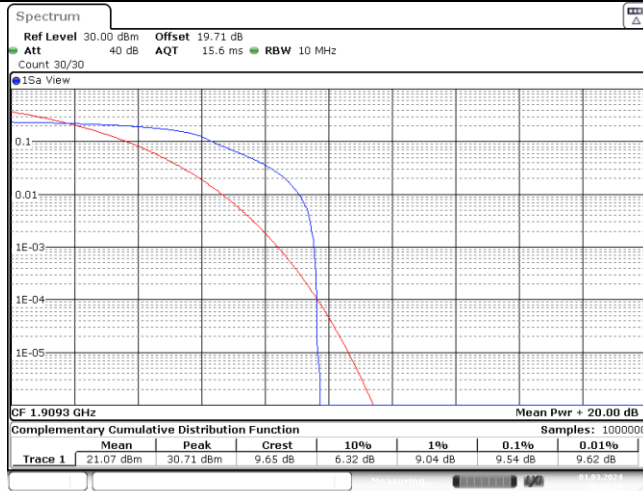

Date: 1.MAR.2024 16:10:19

Band2-1.4MHz-16QAM-19193-6-0-High-9.54-<=13-PASS

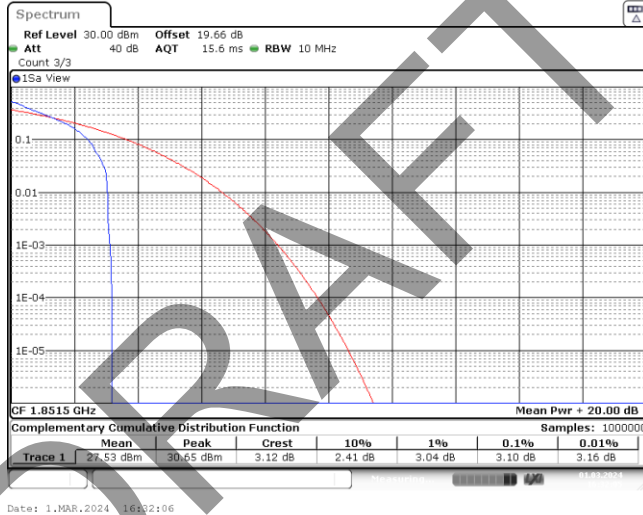

Date: 1.MAR.2024 16:02:06

Band2-3MHz-QPSK-18615-1-0-Low-3.10-<=13-PASS

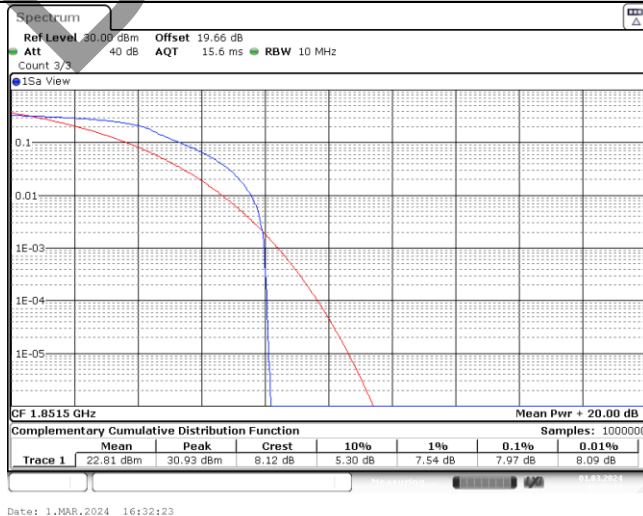

Date: 1.MAR.2024 16:32:23

Band2-3MHz-QPSK-18615-6-0-Low-7.97-<=13-PASS



BUREAU VERITAS

Test Report No.: W7L-P23120015R102

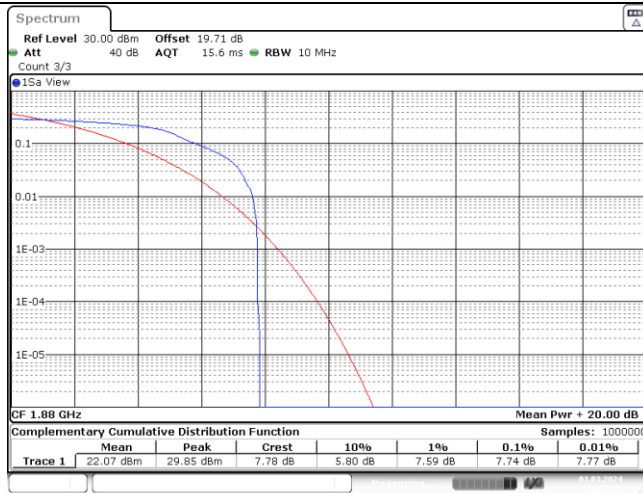

Date: 1.MAR.2024 16:32:41

Band2-3MHz-QPSK-18900-1-0-Low-7.74-<=13-PASS

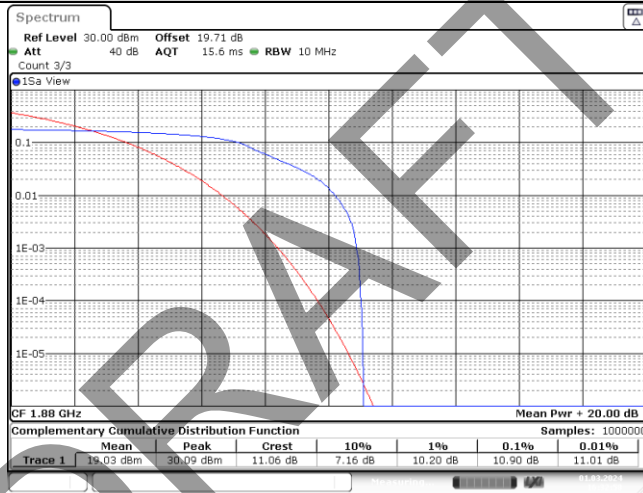

Date: 1.MAR.2024 16:02:58

Band2-3MHz-QPSK-18900-6-0-Low-10.90-<=13-PASS

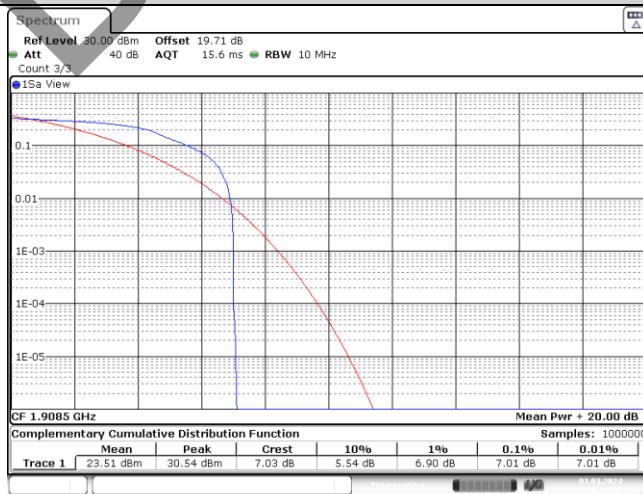

Date: 1.MAR.2024 16:33:17

Band2-3MHz-QPSK-19185-1-0-High-7.01-<=13-PASS

BV 7Layers Communications Technology (Shenzhen) Co., Ltd

Room B37, Warehouse A5, No.3 Chiwan 4th Road, Zhaoshang Street, Nanshan District Shenzhen, Guangdong, People's Republic of China

Tel: +86 755 8869 6566 Fax: +86 755 8869 6577 Email: customerservice.sw@bureauveritas.com

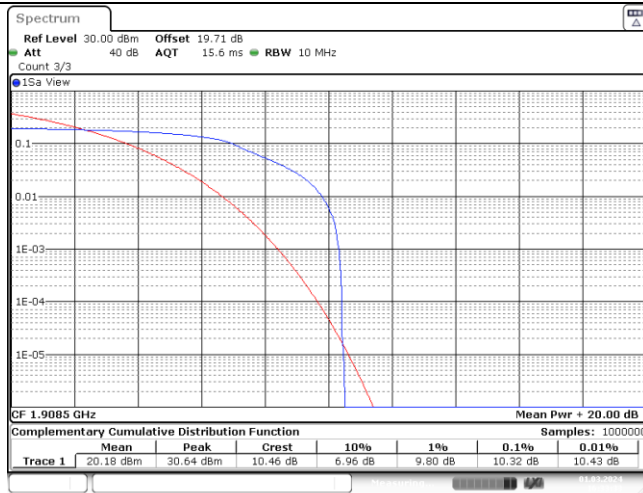

Date: 1.MAR.2024 16:33:33

Band2-3MHz-QPSK-19185-6-0-High-10.32-<=13-PASS

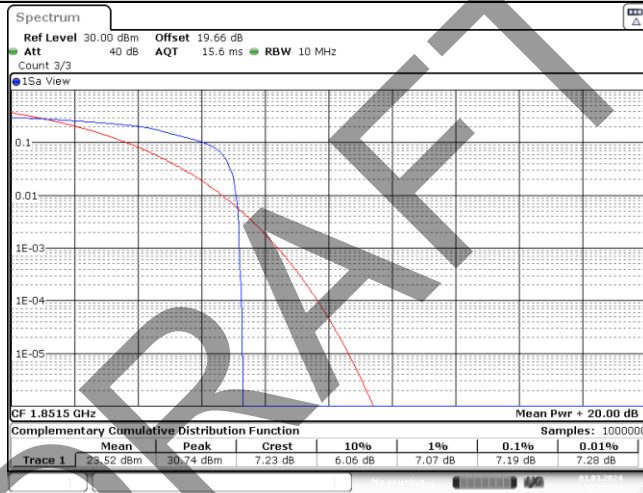

Date: 1.MAR.2024 16:02:14

Band2-3MHz-16QAM-18615-1-0-Low-7.19-<=13-PASS

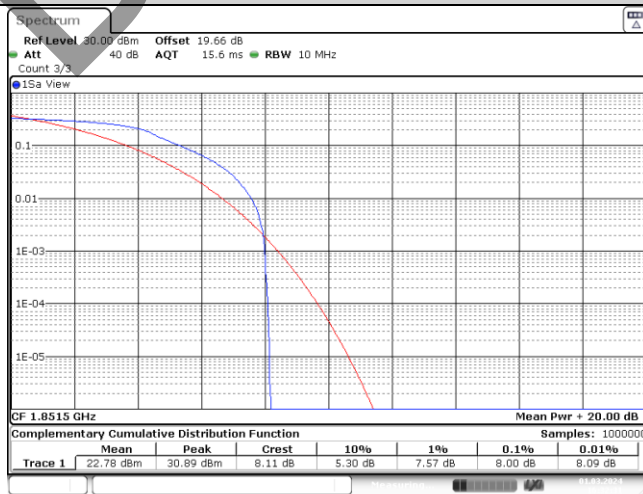

Date: 1.MAR.2024 16:32:31

Band2-3MHz-16QAM-18615-6-0-Low-8.00-<=13-PASS



BUREAU VERITAS

Test Report No.: W7L-P23120015R102

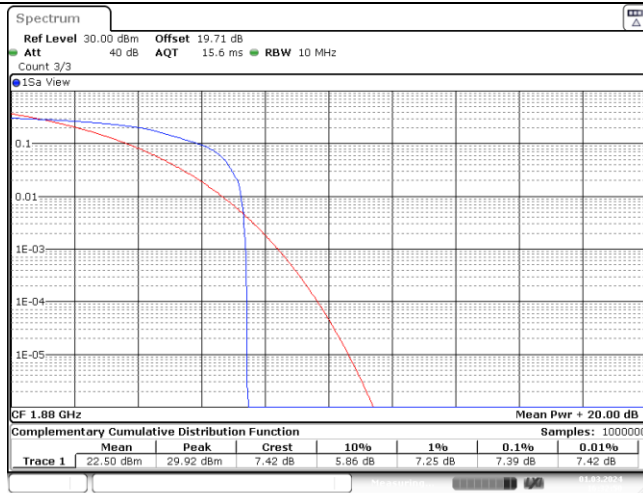

Date: 1.MAR.2024 16:32:50

Band2-3MHz-16QAM-18900-1-0-Low-7.39-<=13-PASS

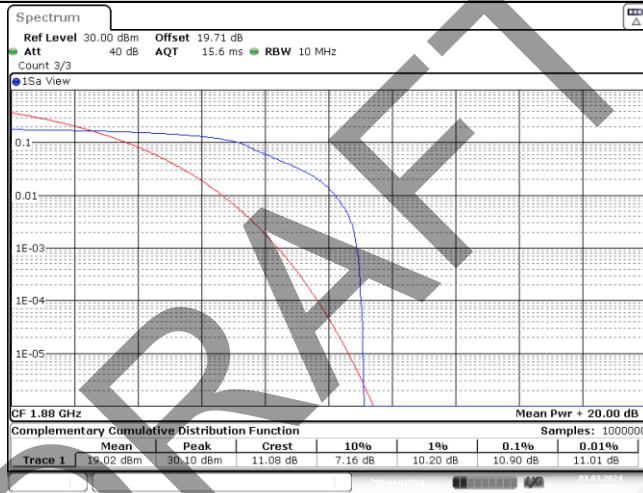

Date: 1.MAR.2024 16:03:06

Band2-3MHz-16QAM-18900-6-0-Low-10.90-<=13-PASS

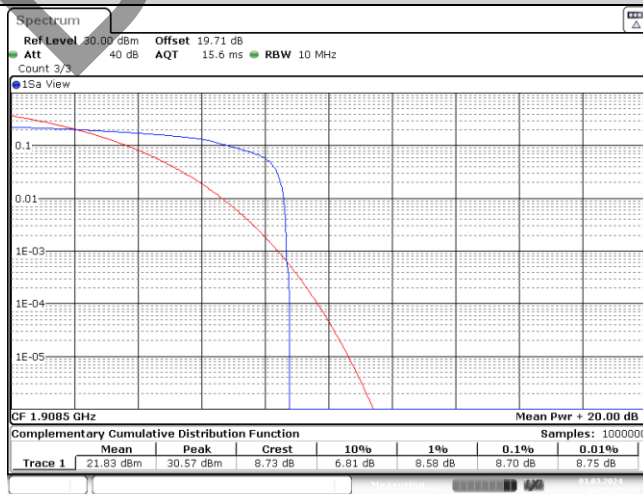

Date: 1.MAR.2024 16:33:25

Band2-3MHz-16QAM-19185-1-0-High-8.70-<=13-PASS



BUREAU VERITAS

Test Report No.: W7L-P23120015R102

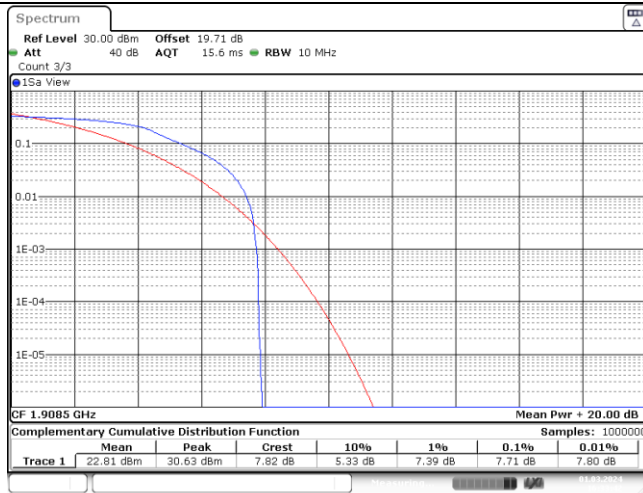

Date: 1.MAR.2024 16:33:42

Band2-3MHz-16QAM-19185-6-0-High-7.71-<=13-PASS

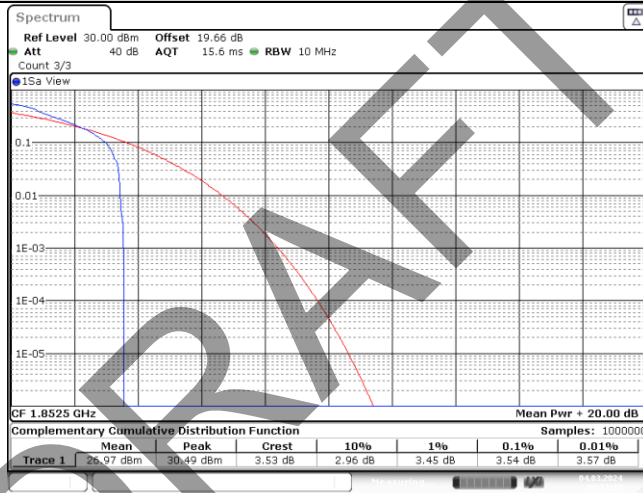

Date: 4.MAR.2024 09:01:38

Band2-5MHz-QPSK-18625-1-0-Low-3.54-<=13-PASS

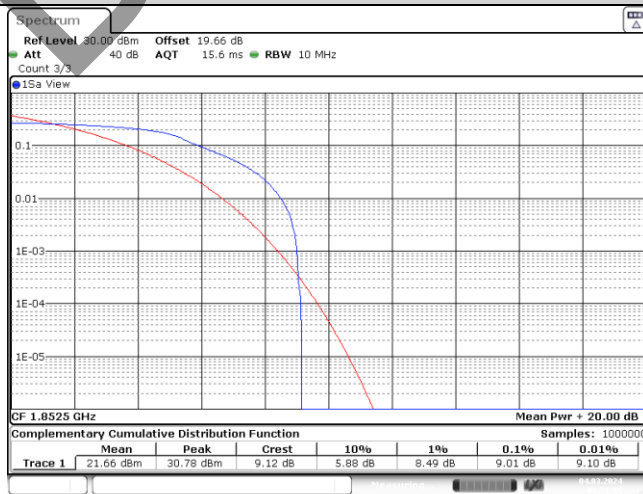

Date: 4.MAR.2024 09:31:56

Band2-5MHz-QPSK-18625-6-0-Low-9.01-<=13-PASS

BV 7Layers Communications Technology (Shenzhen) Co., Ltd

Room B37, Warehouse A5, No.3 Chiwan 4th Road, Zhaoshang Street, Nanshan District Shenzhen, Guangdong, People's Republic of China

Tel: +86 755 8869 6566 Fax: +86 755 8869 6577 Email: customerservice.sw@bureauveritas.com



BUREAU VERITAS

Test Report No.: W7L-P23120015R102

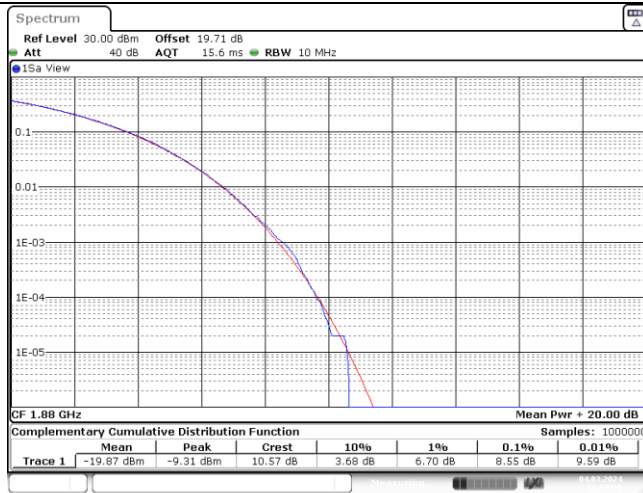

Band2-5MHz-QPSK-18900-1-0-Low-8.55-<=13-PASS

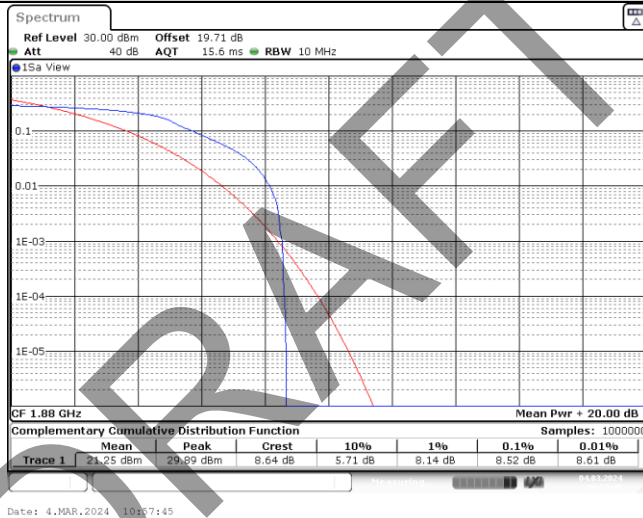

Band2-5MHz-QPSK-18900-6-0-Low-8.52-<=13-PASS

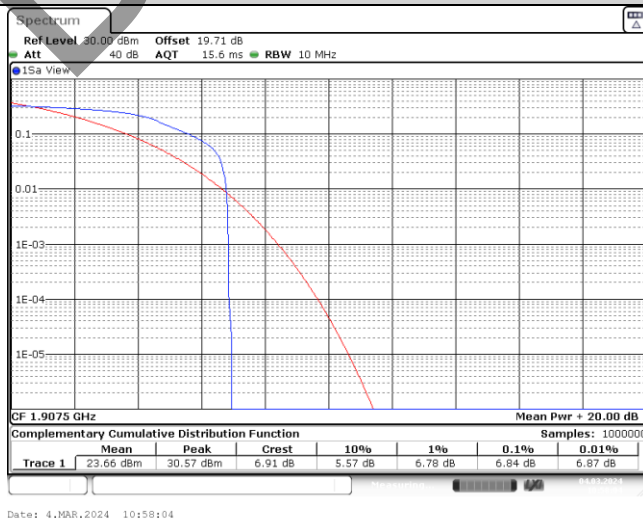

Band2-5MHz-QPSK-19175-1-0-High-6.84-<=13-PASS

BV 7Layers Communications Technology (Shenzhen) Co., Ltd

Room B37, Warehouse A5, No.3 Chiwan 4th Road, Zhaoshang Street, Nanshan District Shenzhen, Guangdong, People's Republic of China

Tel: +86 755 8869 6566
Fax: +86 755 8869 6577

Email: customerservice.sw@bureauveritas.com



BUREAU VERITAS

Test Report No.: W7L-P23120015R102



Date: 4.MAR.2024 10:58:21

Band2-5MHz-QPSK-19175-6-0-High-7.62-<=13-PASS

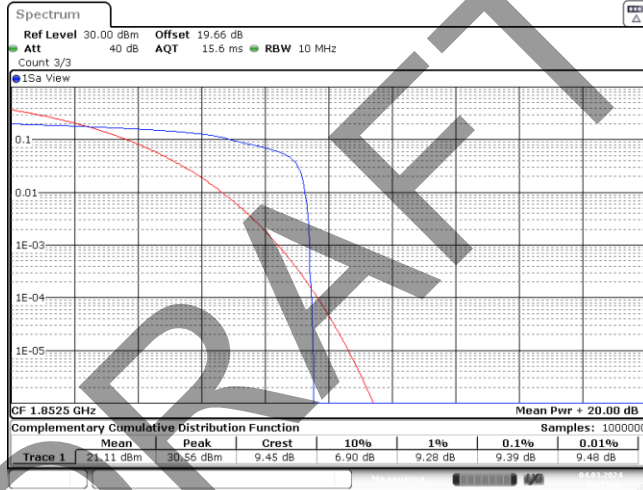

Date: 4.MAR.2024 09:01:47

Band2-5MHz-16QAM-18625-1-0-Low-9.39-<=13-PASS



Date: 4.MAR.2024 09:32:04

Band2-5MHz-16QAM-18625-6-0-Low-10.87-<=13-PASS



BUREAU VERITAS

Test Report No.: W7L-P23120015R102

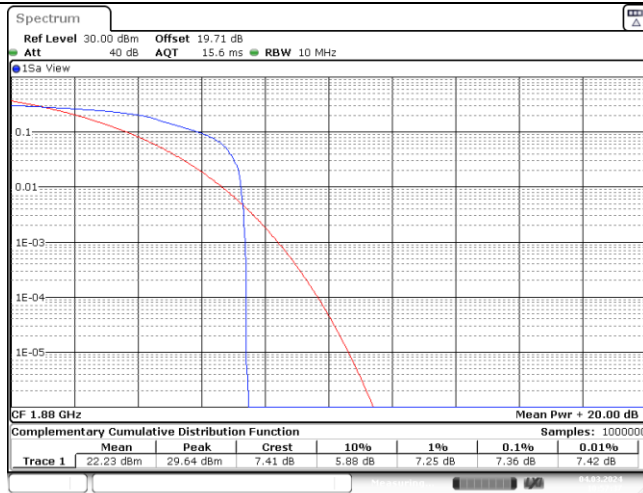

Date: 4.MAR.2024 10:57:36

Band2-5MHz-16QAM-18900-1-0-Low-7.36-<=13-PASS

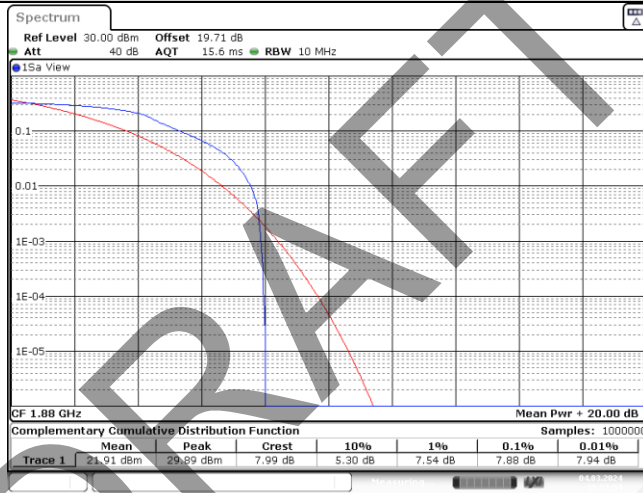

Date: 4.MAR.2024 10:57:54

Band2-5MHz-16QAM-18900-6-0-Low-7.88-<=13-PASS

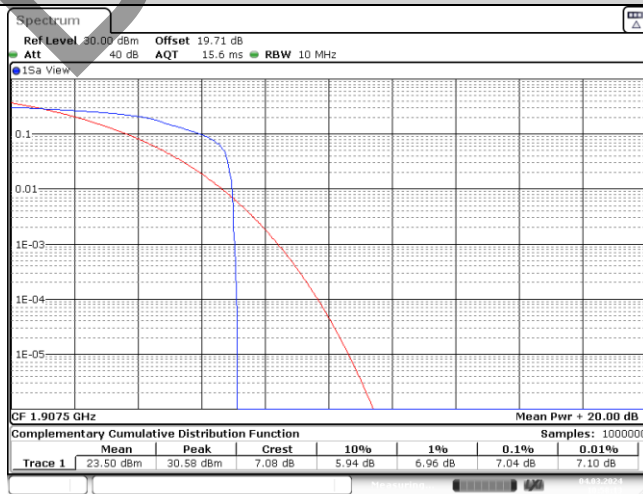

Date: 4.MAR.2024 10:58:13

Band2-5MHz-16QAM-19175-1-0-High-7.04-<=13-PASS

BV 7Layers Communications Technology (Shenzhen) Co., Ltd

Room B37, Warehouse A5, No.3 Chiwan 4th Road, Zhaoshang Street, Nanshan District Shenzhen, Guangdong, People's Republic of China

Tel: +86 755 8869 6566 Fax: +86 755 8869 6577

Email: customerservice.sw@bureauveritas.com



BUREAU VERITAS

Test Report No.: W7L-P23120015R102

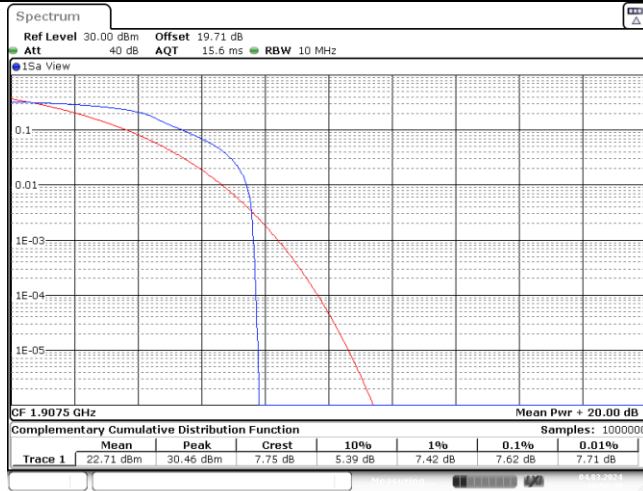

Date: 4.MAR.2024 10:58:30

Band2-5MHz-16QAM-19175-6-0-High-7.62-<=13-PASS

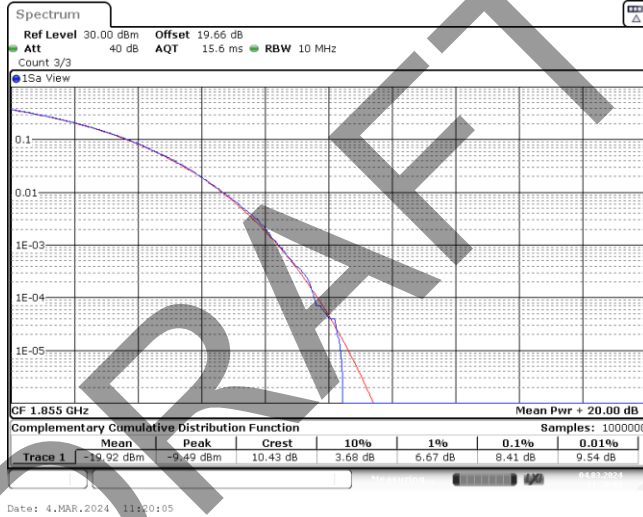

Date: 4.MAR.2024 11:20:05

Band2-10MHz-QPSK-18650-1-0-Low-8.41-<=13-PASS

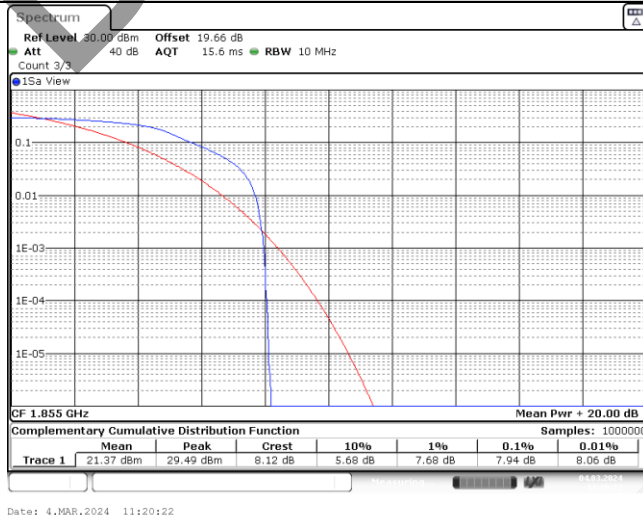

Date: 4.MAR.2024 11:20:22

Band2-10MHz-QPSK-18650-6-0-Low-7.94-<=13-PASS



BUREAU VERITAS

Test Report No.: W7L-P23120015R102

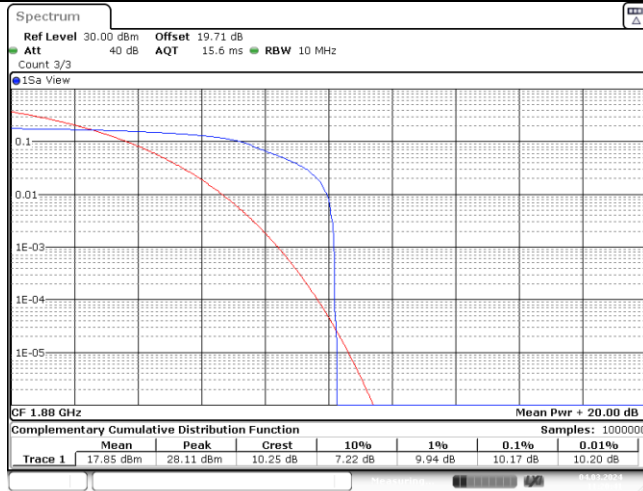

Date: 4.MAR.2024 11:20:41

Band2-10MHz-QPSK-18900-1-0-Low-10.17-<=13-PASS

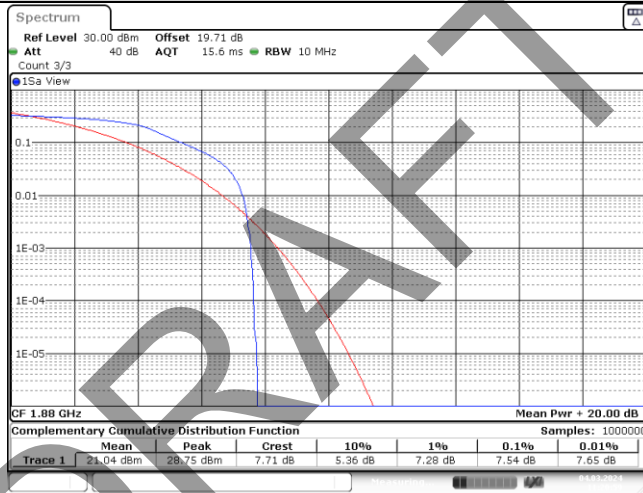

Date: 4.MAR.2024 11:20:59

Band2-10MHz-QPSK-18900-6-0-Low-7.54-<=13-PASS

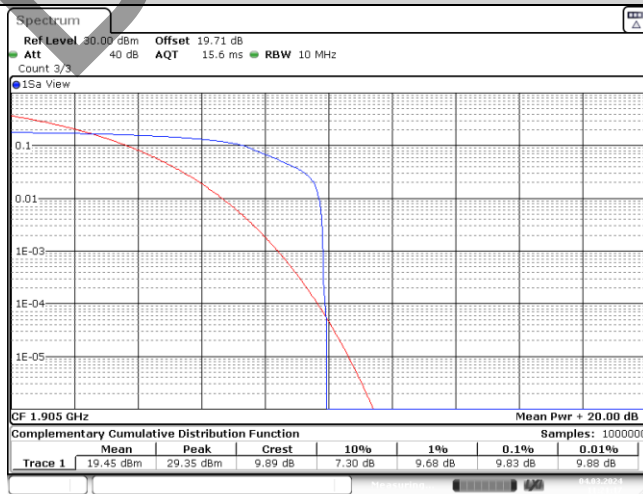

Date: 4.MAR.2024 11:21:17

Band2-10MHz-QPSK-19150-1-0-High-9.83-<=13-PASS



BUREAU VERITAS

Test Report No.: W7L-P23120015R102

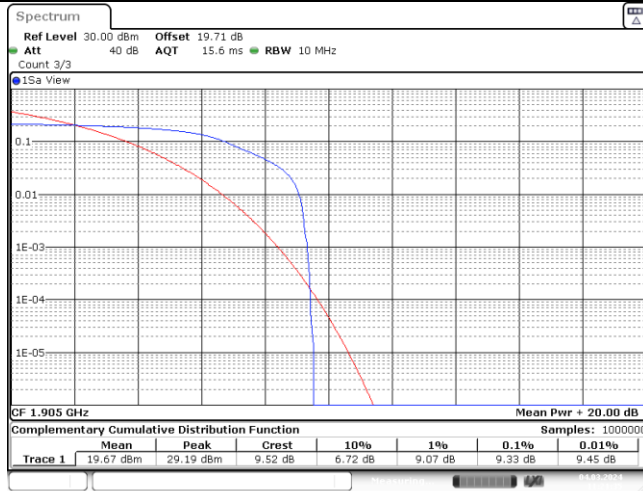

Date: 4.MAR.2024 11:21:35

Band2-10MHz-QPSK-19150-6-0-High-9.33-<=13-PASS

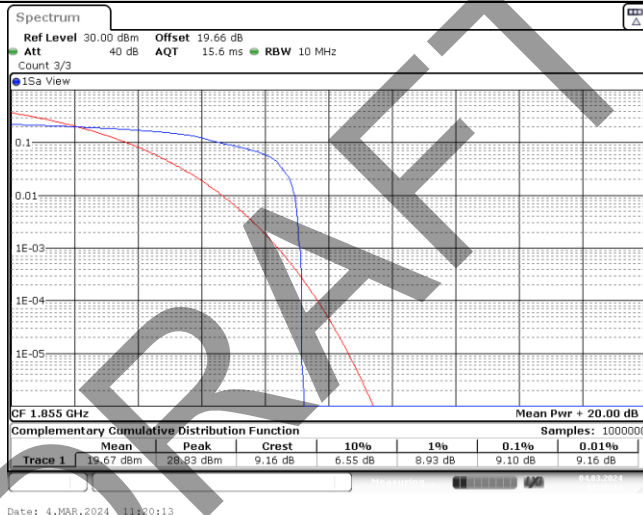

Date: 4.MAR.2024 11:20:13

Band2-10MHz-16QAM-18650-1-0-Low-9.10-<=13-PASS

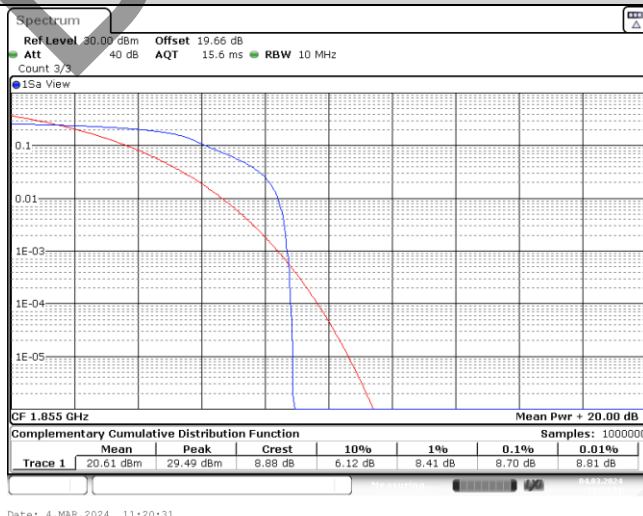

Date: 4.MAR.2024 11:20:31

Band2-10MHz-16QAM-18650-6-0-Low-8.70-<=13-PASS

BV 7Layers Communications Technology (Shenzhen) Co., Ltd

Room B37, Warehouse A5, No.3 Chiwan 4th Road, Zhaoshang Street, Nanshan District Shenzhen, Guangdong, People's Republic of China

Tel: +86 755 8869 6566 Fax: +86 755 8869 6577

Email: customerservice.sw@bureauveritas.com



BUREAU VERITAS

Test Report No.: W7L-P23120015R102

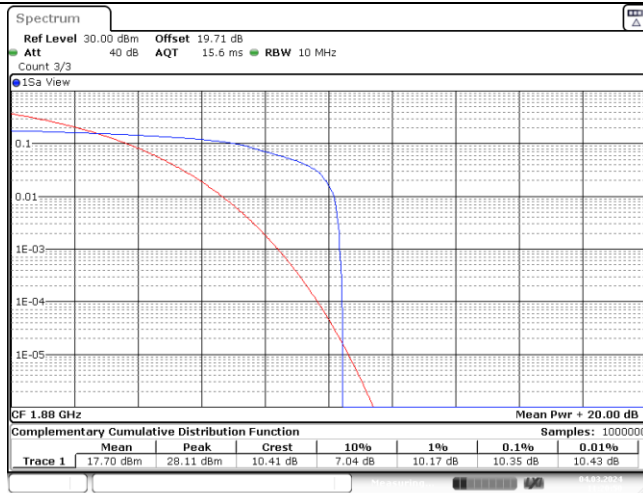

Date: 4.MAR.2024 11:20:50

Band2-10MHz-16QAM-18900-1-0-Low-10.35-<=13-PASS

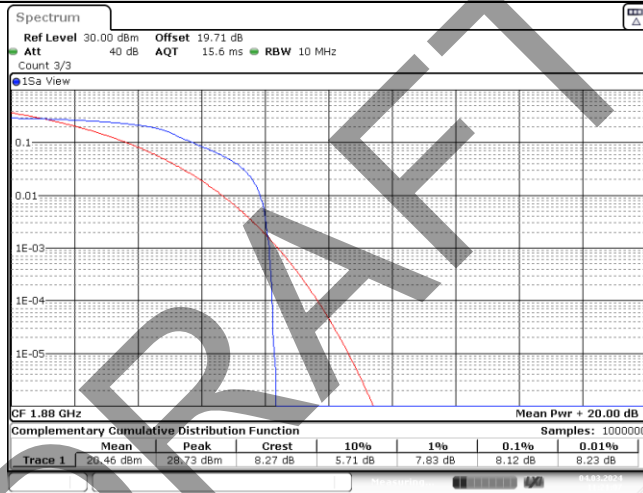

Date: 4.MAR.2024 11:21:07

Band2-10MHz-16QAM-18900-6-0-Low-8.12-<=13-PASS

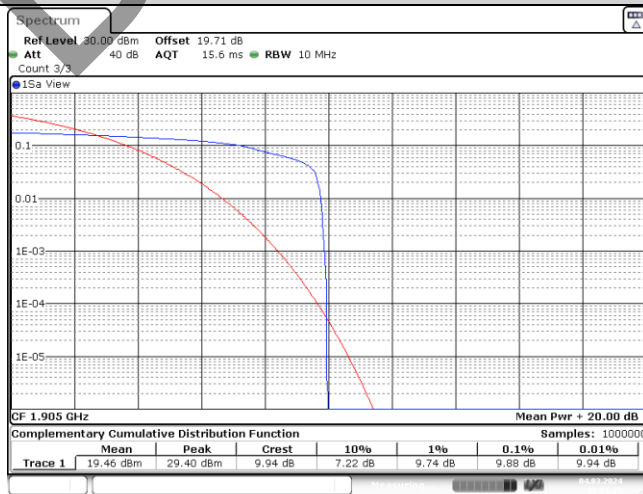

Date: 4.MAR.2024 11:21:26

Band2-10MHz-16QAM-19150-1-0-High-9.88-<=13-PASS

BV 7Layers Communications Technology (Shenzhen) Co., Ltd

Room B37, Warehouse A5, No.3 Chiwan 4th Road, Zhaoshang Street, Nanshan District Shenzhen, Guangdong, People's Republic of China

Tel: +86 755 8869 6566

Fax: +86 755 8869 6577

Email: customerservice.sw@bureauveritas.com



BUREAU VERITAS

Test Report No.: W7L-P23120015R102

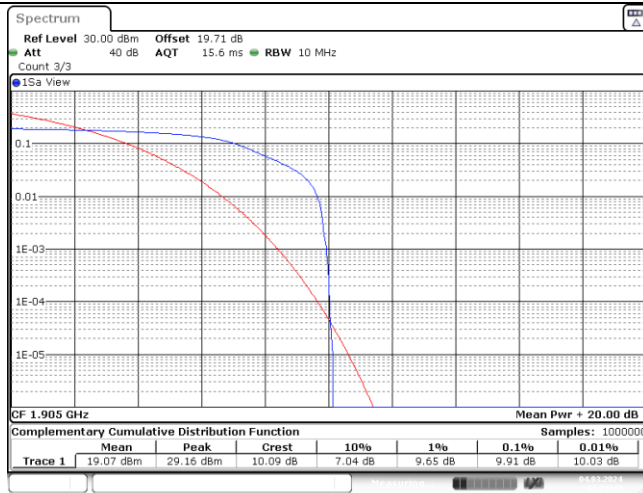

Date: 4.MAR.2024 11:21:43

Band2-10MHz-16QAM-19150-6-0-High-9.91-<=13-PASS

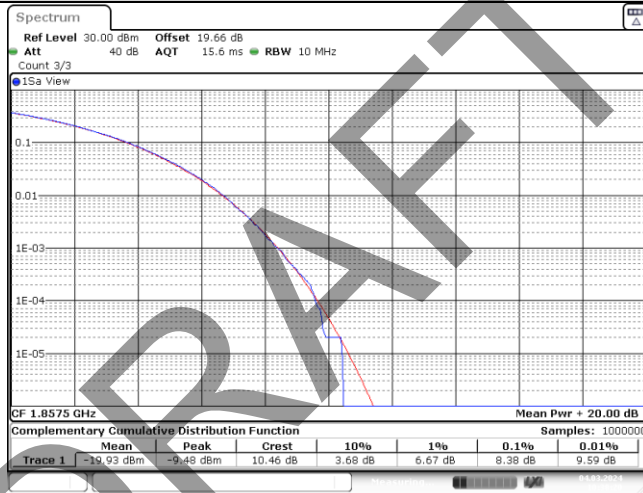

Date: 4.MAR.2024 10:08:19

Band2-15MHz-QPSK-18675-1-0-Low-8.38-<=13-PASS

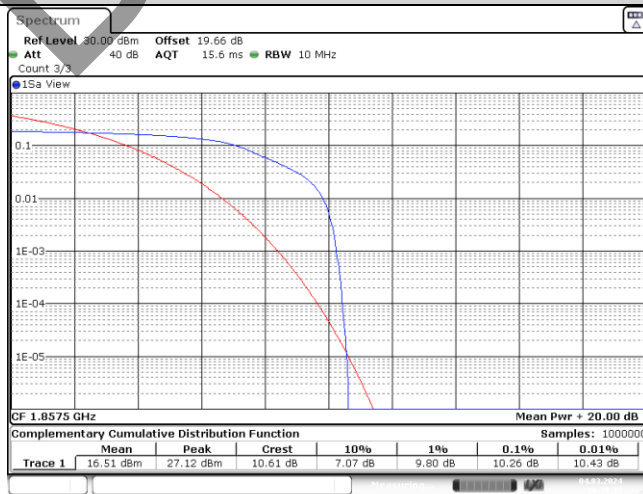

Date: 4.MAR.2024 10:38:38

Band2-15MHz-QPSK-18675-6-0-Low-10.26-<=13-PASS

BV 7Layers Communications Technology (Shenzhen) Co., Ltd

Room B37, Warehouse A5, No.3 Chiwan 4th Road, Zhaoshang Street, Nanshan District Shenzhen, Guangdong, People's Republic of China

Tel: +86 755 8869 6566 Fax: +86 755 8869 6577

Email: customerservice.sw@bureauveritas.com

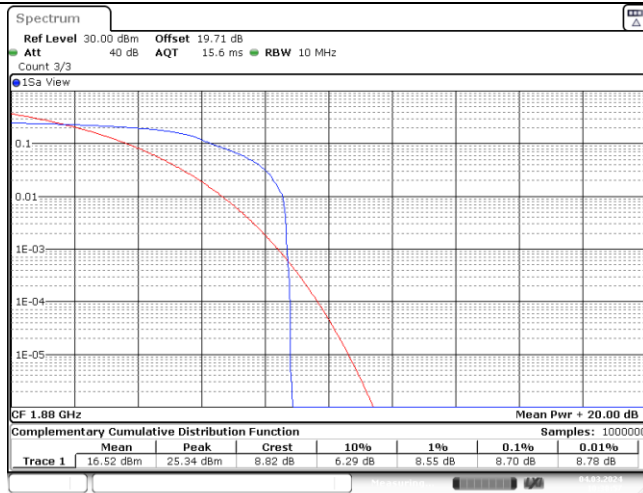

Date: 4.MAR.2024 10:38:57

Band2-15MHz-QPSK-18900-1-0-Low-8.70-<=13-PASS

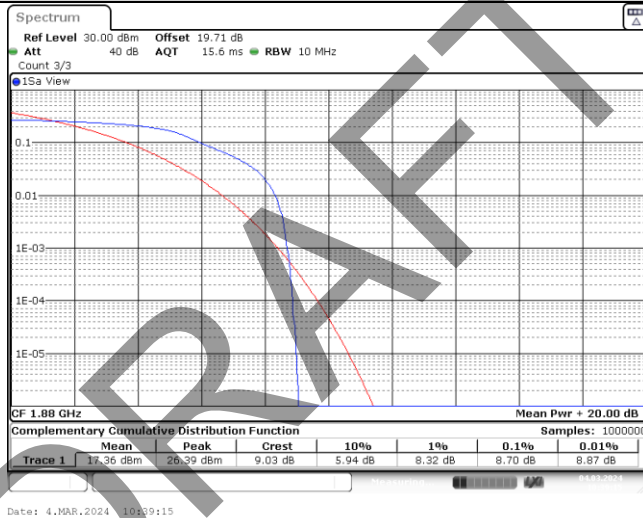

Date: 4.MAR.2024 10:39:15

Band2-15MHz-QPSK-18900-6-0-Low-8.70-<=13-PASS

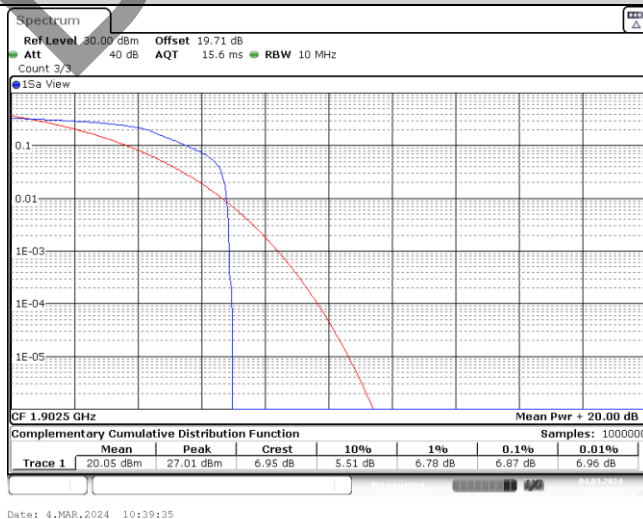

Date: 4.MAR.2024 10:39:35

Band2-15MHz-QPSK-19125-1-0-High-6.87-<=13-PASS



BUREAU VERITAS

Test Report No.: W7L-P23120015R102

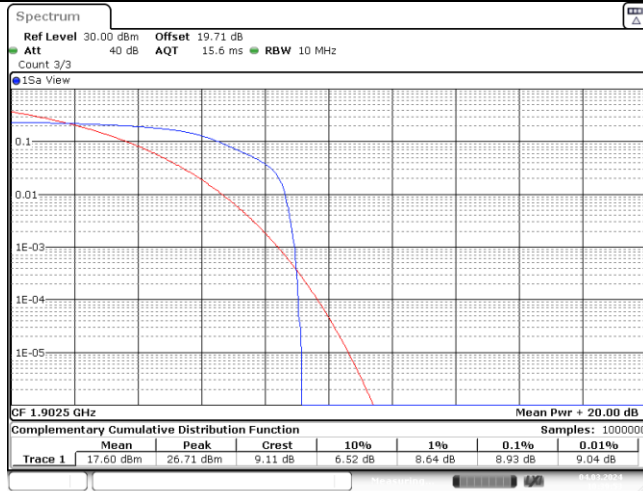

Band2-15MHz-QPSK-19125-6-0-High-8.93-<=13-PASS

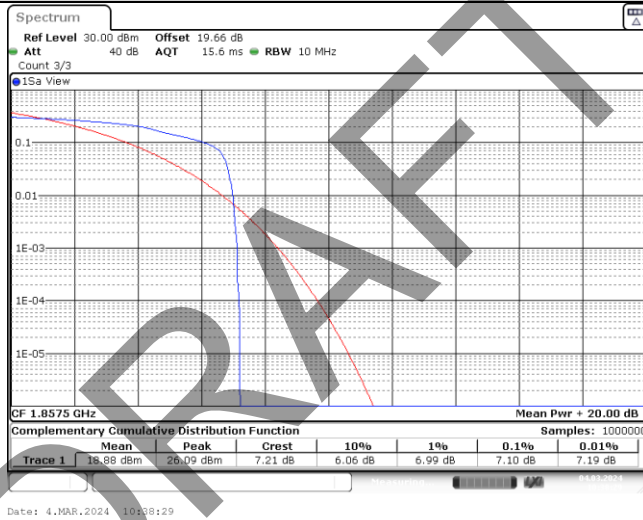

Band2-15MHz-16QAM-18675-1-0-Low-7.10-<=13-PASS

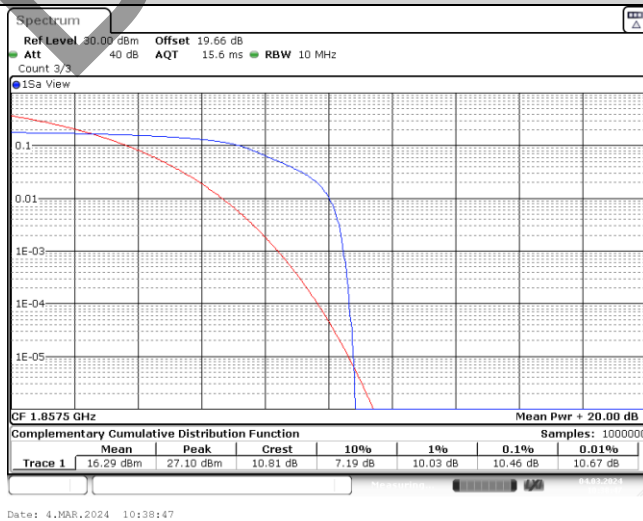

Band2-15MHz-16QAM-18675-6-0-Low-10.46-<=13-PASS

BV 7Layers Communications Technology (Shenzhen) Co., Ltd

Room B37, Warehouse A5, No.3 Chiwan 4th Road, Zhaoshang Street, Nanshan District Shenzhen, Guangdong, People's Republic of China

Tel: +86 755 8869 6566

Fax: +86 755 8869 6577

Email: customerservice.sw@bureauveritas.com



BUREAU VERITAS

Test Report No.: W7L-P23120015R102

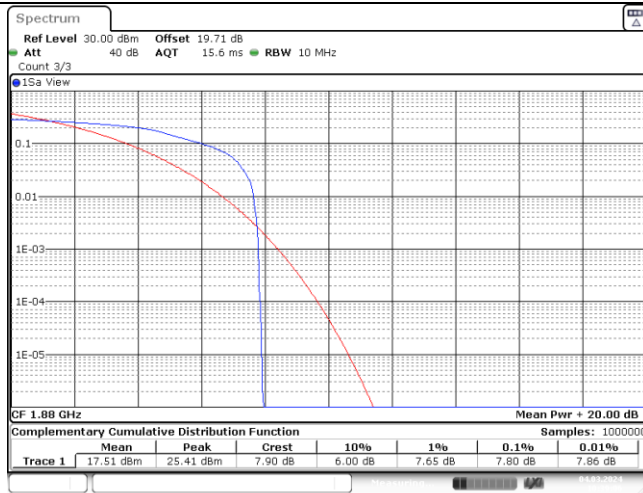

Date: 4.MAR.2024 10:39:06

Band2-15MHz-16QAM-18900-1-0-Low-7.80-<=13-PASS

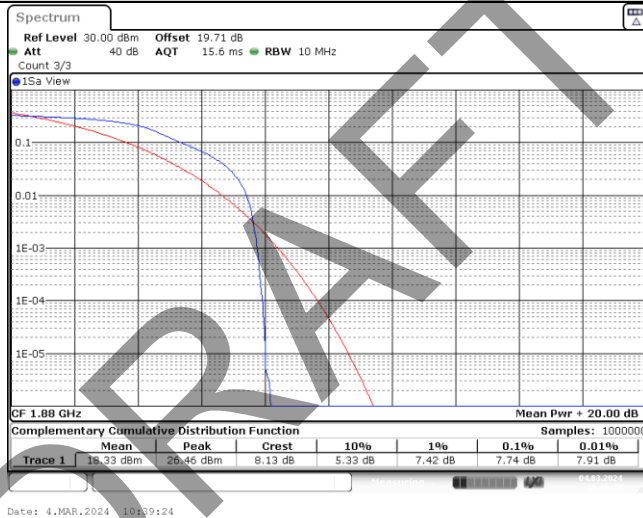

Date: 4.MAR.2024 10:39:24

Band2-15MHz-16QAM-18900-6-0-Low-7.74-<=13-PASS

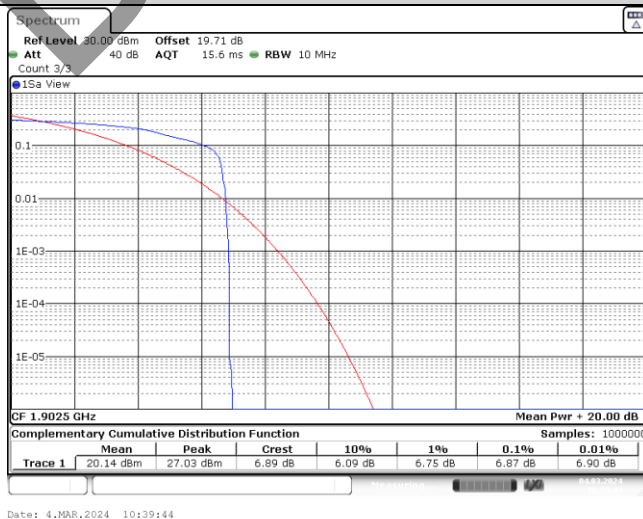

Date: 4.MAR.2024 10:39:44

Band2-15MHz-16QAM-19125-1-0-High-6.87-<=13-PASS

BV 7Layers Communications Technology (Shenzhen) Co., Ltd

Room B37, Warehouse A5, No.3 Chiwan 4th Road, Zhaoshang Street, Nanshan District Shenzhen, Guangdong, People's Republic of China

Tel: +86 755 8869 6566 Fax: +86 755 8869 6577

Email: customerservice.sw@bureauveritas.com



BUREAU VERITAS

Test Report No.: W7L-P23120015R102

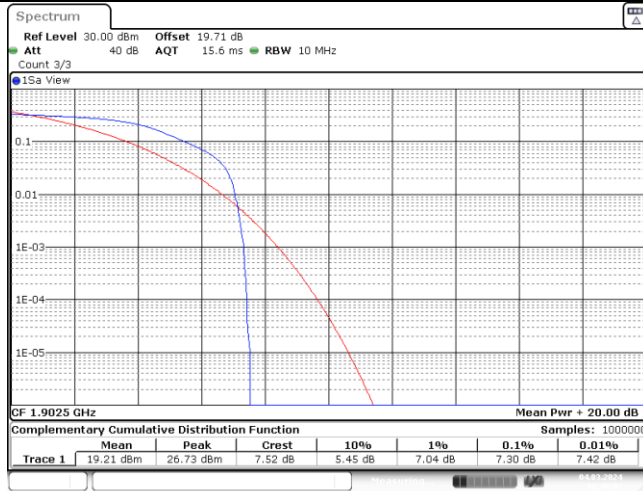

Date: 4.MAR.2024 10:40:02

Band2-15MHz-16QAM-19125-6-0-High-7.30-<=13-PASS

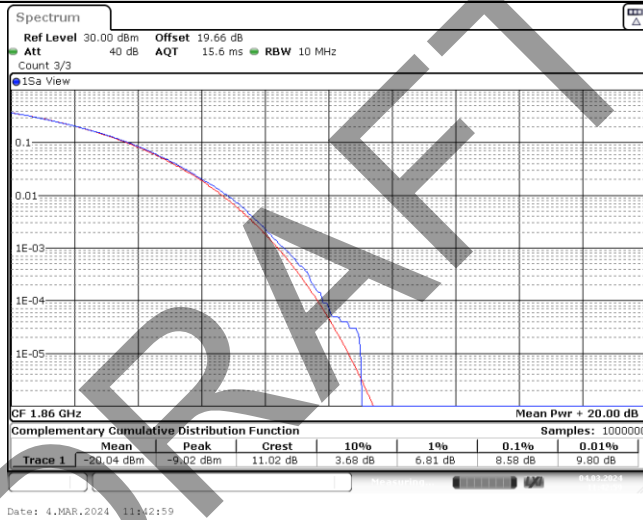

Date: 4.MAR.2024 11:42:59

Band2-20MHz-QPSK-18700-1-0-Low-8.58-<=13-PASS

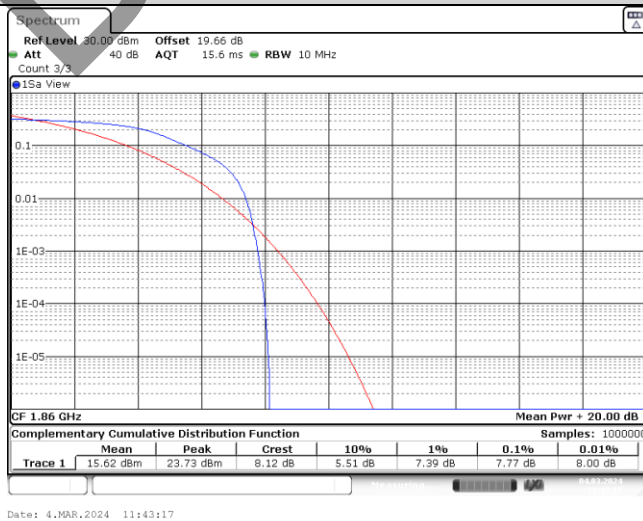

Date: 4.MAR.2024 11:43:17

Band2-20MHz-QPSK-18700-6-0-Low-7.77-<=13-PASS

BV 7Layers Communications Technology (Shenzhen) Co., Ltd

Room B37, Warehouse A5, No.3 Chiwan 4th Road, Zhaoshang Street, Nanshan District Shenzhen, Guangdong, People's Republic of China

Tel: +86 755 8869 6566 Fax: +86 755 8869 6577

Email: customerservice.sw@bureauveritas.com



BUREAU VERITAS

Test Report No.: W7L-P23120015R102

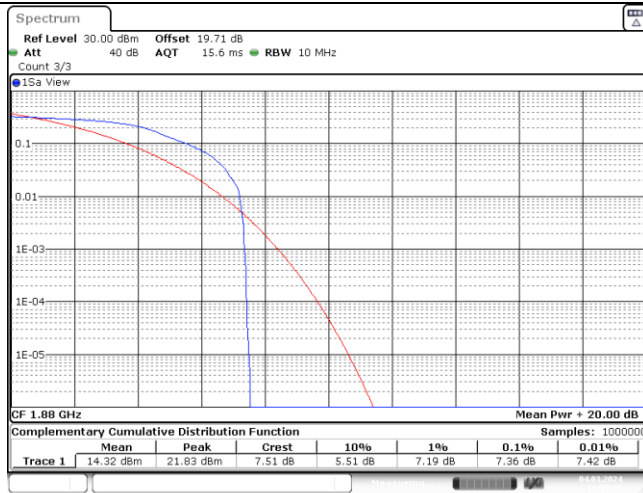

Date: 4.MAR.2024 11:43:37

Band2-20MHz-QPSK-18900-1-0-Low-7.36-<=13-PASS

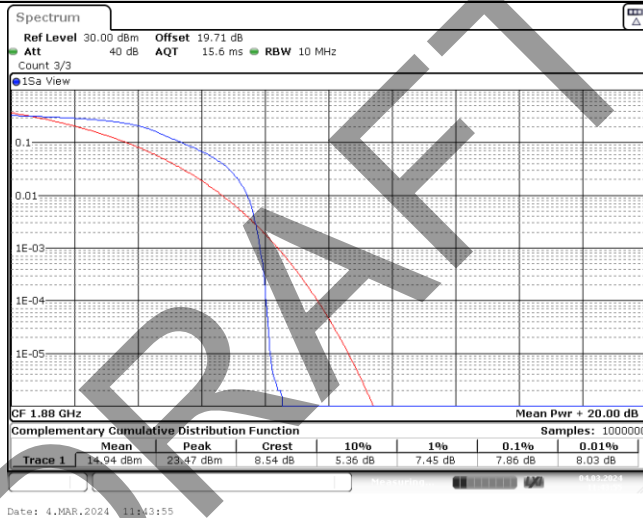

Date: 4.MAR.2024 11:43:55

Band2-20MHz-QPSK-18900-6-0-Low-7.86-<=13-PASS

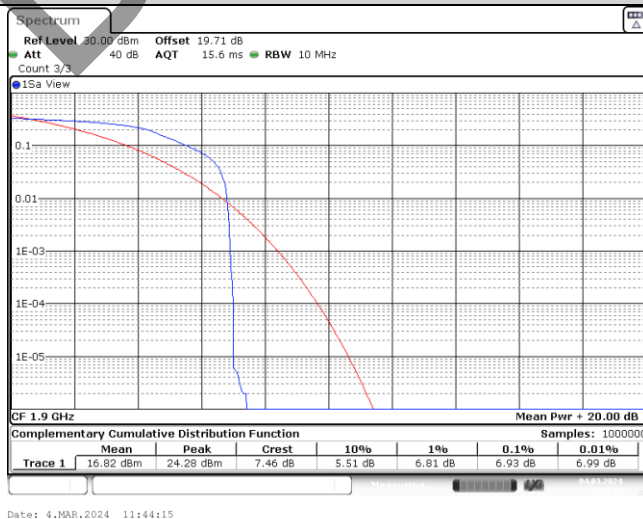

Date: 4.MAR.2024 11:44:15

Band2-20MHz-QPSK-19100-1-0-High-6.93-<=13-PASS

BV 7Layers Communications Technology (Shenzhen) Co., Ltd

Room B37, Warehouse A5, No.3 Chiwan 4th Road, Zhaoshang Street, Nanshan District Shenzhen, Guangdong, People's Republic of China

Tel: +86 755 8869 6566 Fax: +86 755 8869 6577

Email: customerservice.sw@bureauveritas.com



BUREAU VERITAS

Test Report No.: W7L-P23120015R102

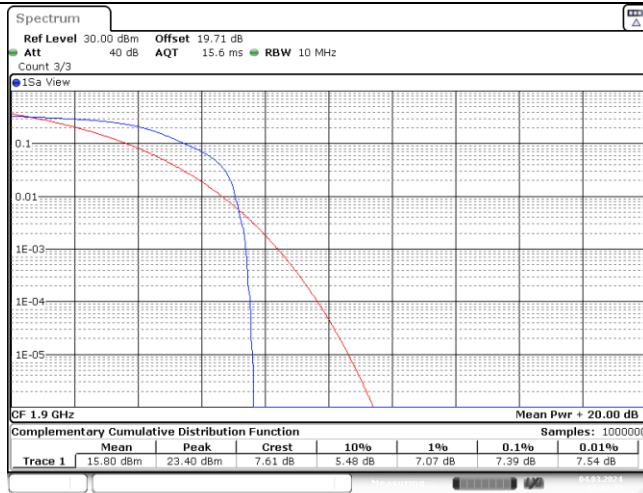

Date: 4.MAR.2024 11:44:33

Band2-20MHz-QPSK-19100-6-0-High-7.39-<=13-PASS

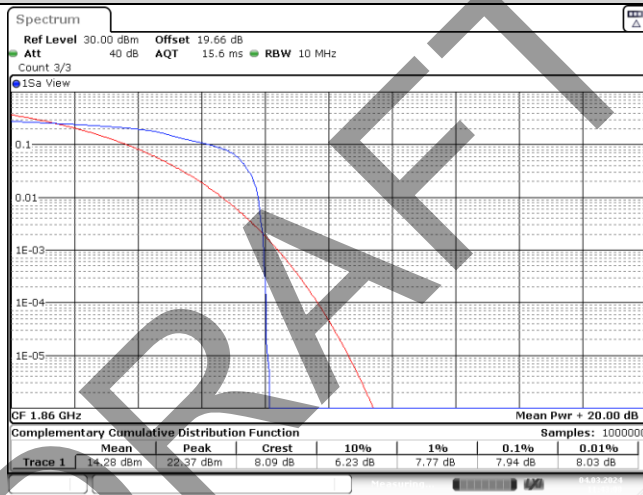

Date: 4.MAR.2024 11:43:08

Band2-20MHz-16QAM-18700-1-0-Low-7.94-<=13-PASS

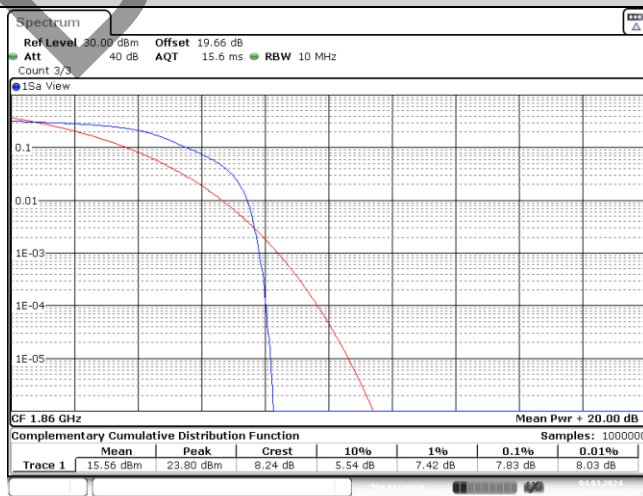

Date: 4.MAR.2024 11:43:26

Band2-20MHz-16QAM-18700-6-0-Low-7.83-<=13-PASS

BV 7Layers Communications Technology (Shenzhen) Co., Ltd

Room B37, Warehouse A5, No.3 Chiwan 4th Road, Zhaoshang Street, Nanshan District Shenzhen, Guangdong, People's Republic of China

Tel: +86 755 8869 6566 Fax: +86 755 8869 6577

Email: customerservice.sw@bureauveritas.com



BUREAU VERITAS

Test Report No.: W7L-P23120015R102

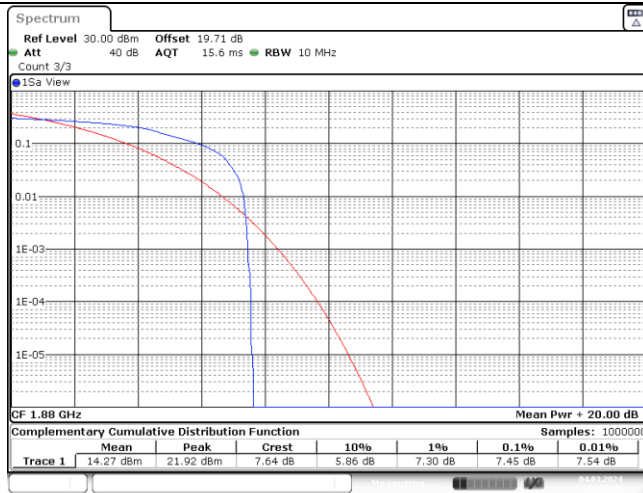

Date: 4.MAR.2024 11:43:46

Band2-20MHz-16QAM-18900-1-0-Low-7.45-<=13-PASS

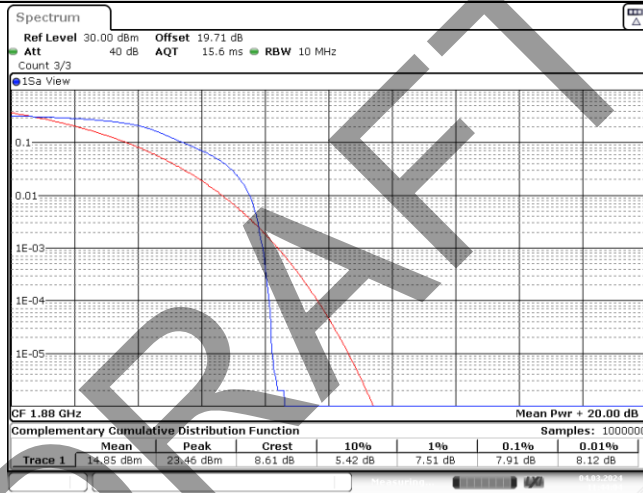

Date: 4.MAR.2024 11:44:04

Band2-20MHz-16QAM-18900-6-0-Low-7.91-<=13-PASS

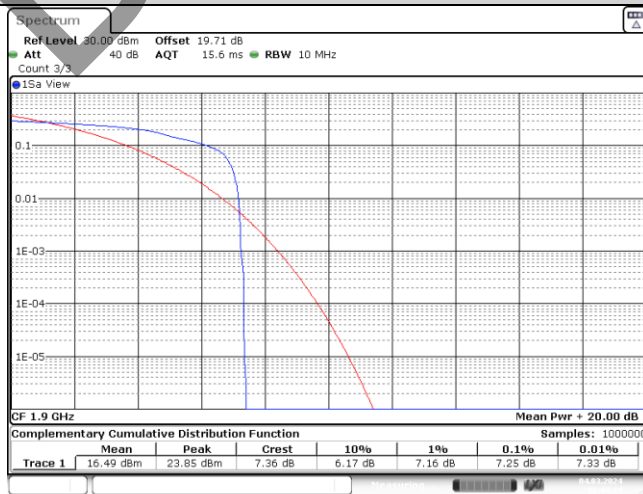

Date: 4.MAR.2024 11:44:24

Band2-20MHz-16QAM-19100-1-0-High-7.25-<=13-PASS

BV 7Layers Communications Technology (Shenzhen) Co., Ltd

Room B37, Warehouse A5, No.3 Chiwan 4th Road, Zhaoshang Street, Nanshan District Shenzhen, Guangdong, People's Republic of China

Tel: +86 755 8869 6566 Fax: +86 755 8869 6577

Email: customerservice.sw@bureauveritas.com



**BUREAU
VERITAS**

Test Report No.: W7L-P23120015R102

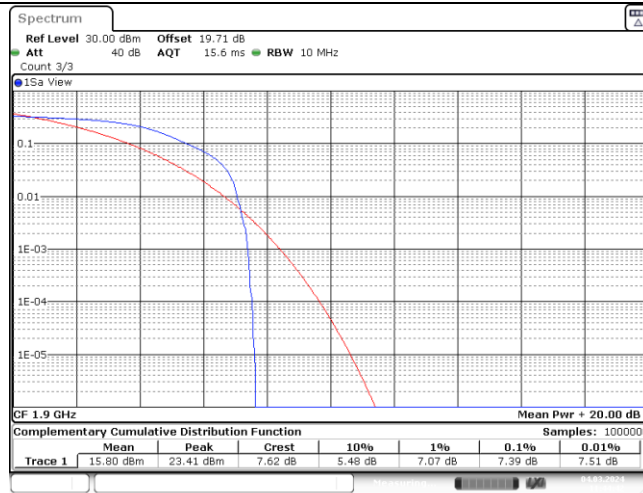

Date: 4.MAR.2024 11:44:42

Band2-20MHz-16QAM-19100-6-0-High-7.39-<=13-PASS

BAND 25 TEST RESULT

Band	Bandwidth	Modulation	Channel	RB Size	RB Start	NBIndex	Result(dB)	Limit(dB)	Verdict
Band25	1.4MHz	26047	QPSK	1	0	Low	8.49	<=13	PASS
Band25	1.4MHz	26047	QPSK	6	0	Low	10.70	<=13	PASS
Band25	1.4MHz	26365	QPSK	1	0	Low	7.07	<=13	PASS
Band25	1.4MHz	26365	QPSK	6	0	Low	8.23	<=13	PASS
Band25	1.4MHz	26683	QPSK	1	0	High	6.84	<=13	PASS
Band25	1.4MHz	26683	QPSK	6	0	High	8.84	<=13	PASS
Band25	1.4MHz	26047	16QAM	1	0	Low	7.71	<=13	PASS
Band25	1.4MHz	26047	16QAM	6	0	Low	8.43	<=13	PASS
Band25	1.4MHz	26365	16QAM	1	0	Low	9.19	<=13	PASS
Band25	1.4MHz	26365	16QAM	6	0	Low	8.23	<=13	PASS
Band25	1.4MHz	26683	16QAM	1	0	High	6.17	<=13	PASS
Band25	1.4MHz	26683	16QAM	6	0	High	8.14	<=13	PASS
Band25	3MHz	26055	QPSK	1	0	Low	4.81	<=13	PASS
Band25	3MHz	26055	QPSK	6	0	Low	9.04	<=13	PASS
Band25	3MHz	26365	QPSK	1	0	Low	7.36	<=13	PASS
Band25	3MHz	26365	QPSK	6	0	Low	10.81	<=13	PASS
Band25	3MHz	26675	QPSK	1	0	High	8.26	<=13	PASS
Band25	3MHz	26675	QPSK	6	0	High	10.58	<=13	PASS
Band25	3MHz	26055	16QAM	1	0	Low	10.72	<=13	PASS
Band25	3MHz	26055	16QAM	6	0	Low	10.41	<=13	PASS
Band25	3MHz	26365	16QAM	1	0	Low	9.94	<=13	PASS
Band25	3MHz	26365	16QAM	6	0	Low	9.65	<=13	PASS
Band25	3MHz	26675	16QAM	1	0	High	9.42	<=13	PASS
Band25	3MHz	26675	16QAM	6	0	High	10.00	<=13	PASS
Band25	5MHz	26065	QPSK	1	0	Low	7.83	<=13	PASS
Band25	5MHz	26065	QPSK	6	0	Low	8.46	<=13	PASS
Band25	5MHz	26365	QPSK	1	0	Low	7.16	<=13	PASS
Band25	5MHz	26365	QPSK	6	0	Low	10.64	<=13	PASS
Band25	5MHz	26665	QPSK	1	0	High	8.41	<=13	PASS
Band25	5MHz	26665	QPSK	6	0	High	7.51	<=13	PASS

BV 7Layers Communications Technology
(Shenzhen) Co., Ltd

Room B37, Warehouse A5, No.3 Chiwan 4th Road,
Zhaoshang Street, Nanshan District Shenzhen,
Guangdong, People's Republic of China

Tel: +86 755 8869 6566

Fax: +86 755 8869 6577

Email: customerservice.sw@bureauveritas.com



Band25	5MHz	26065	16QAM	1	0	Low	7.88	<=13	PASS
Band25	5MHz	26065	16QAM	6	0	Low	8.43	<=13	PASS
Band25	5MHz	26365	16QAM	1	0	Low	8.90	<=13	PASS
Band25	5MHz	26365	16QAM	6	0	Low	7.94	<=13	PASS
Band25	5MHz	26665	16QAM	1	0	High	6.43	<=13	PASS
Band25	5MHz	26665	16QAM	6	0	High	7.77	<=13	PASS
Band25	10MHz	26090	QPSK	1	0	Low	3.48	<=13	PASS
Band25	10MHz	26090	QPSK	6	0	Low	8.09	<=13	PASS
Band25	10MHz	26365	QPSK	1	0	Low	7.94	<=13	PASS
Band25	10MHz	26365	QPSK	6	0	Low	9.28	<=13	PASS
Band25	10MHz	26640	QPSK	1	0	High	7.16	<=13	PASS
Band25	10MHz	26640	QPSK	6	0	High	8.12	<=13	PASS
Band25	10MHz	26090	16QAM	1	0	Low	7.94	<=13	PASS
Band25	10MHz	26090	16QAM	6	0	Low	9.51	<=13	PASS
Band25	10MHz	26365	16QAM	1	0	Low	9.97	<=13	PASS
Band25	10MHz	26365	16QAM	6	0	Low	7.97	<=13	PASS
Band25	10MHz	26640	16QAM	1	0	High	8.64	<=13	PASS
Band25	10MHz	26640	16QAM	6	0	High	7.91	<=13	PASS
Band25	15MHz	26115	QPSK	1	0	Low	8.52	<=13	PASS
Band25	15MHz	26115	QPSK	6	0	Low	9.77	<=13	PASS
Band25	15MHz	26365	QPSK	1	0	Low	8.14	<=13	PASS
Band25	15MHz	26365	QPSK	6	0	Low	8.41	<=13	PASS
Band25	15MHz	26615	QPSK	1	0	High	7.16	<=13	PASS
Band25	15MHz	26615	QPSK	6	0	High	9.39	<=13	PASS
Band25	15MHz	26115	16QAM	1	0	Low	9.74	<=13	PASS
Band25	15MHz	26115	16QAM	6	0	Low	8.09	<=13	PASS
Band25	15MHz	26365	16QAM	1	0	Low	9.74	<=13	PASS
Band25	15MHz	26365	16QAM	6	0	Low	10.93	<=13	PASS
Band25	15MHz	26615	16QAM	1	0	High	10.20	<=13	PASS
Band25	15MHz	26615	16QAM	6	0	High	9.48	<=13	PASS
Band25	20MHz	26140	QPSK	1	0	Low	4.03	<=13	PASS
Band25	20MHz	26140	QPSK	6	0	Low	9.01	<=13	PASS
Band25	20MHz	26365	QPSK	1	0	Low	9.65	<=13	PASS
Band25	20MHz	26365	QPSK	6	0	Low	10.58	<=13	PASS
Band25	20MHz	26590	QPSK	1	0	High	9.80	<=13	PASS
Band25	20MHz	26590	QPSK	6	0	High	10.38	<=13	PASS
Band25	20MHz	26140	16QAM	1	0	Low	8.96	<=13	PASS
Band25	20MHz	26140	16QAM	6	0	Low	9.80	<=13	PASS
Band25	20MHz	26365	16QAM	1	0	Low	10.90	<=13	PASS
Band25	20MHz	26365	16QAM	6	0	Low	10.72	<=13	PASS
Band25	20MHz	26590	16QAM	1	0	High	8.41	<=13	PASS
Band25	20MHz	26590	16QAM	6	0	High	7.71	<=13	PASS



BUREAU VERITAS

Test Report No.: W7L-P23120015R102

BAND 25 TEST GRAPHS

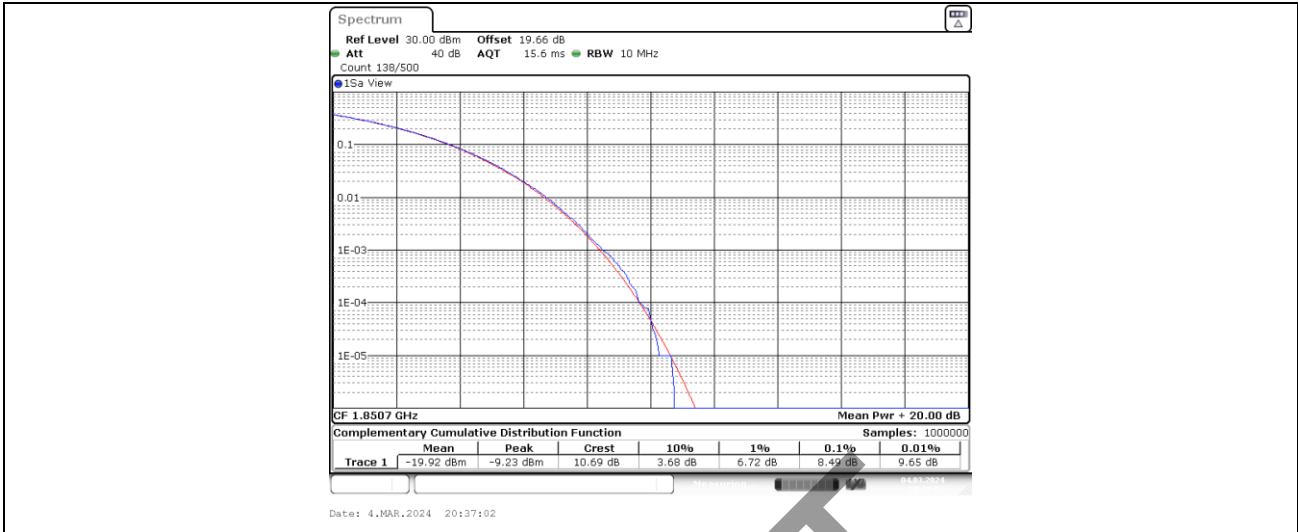

Band25-1.4MHz-QPSK-26047-1-0-Low-8.49-<=13-PASS

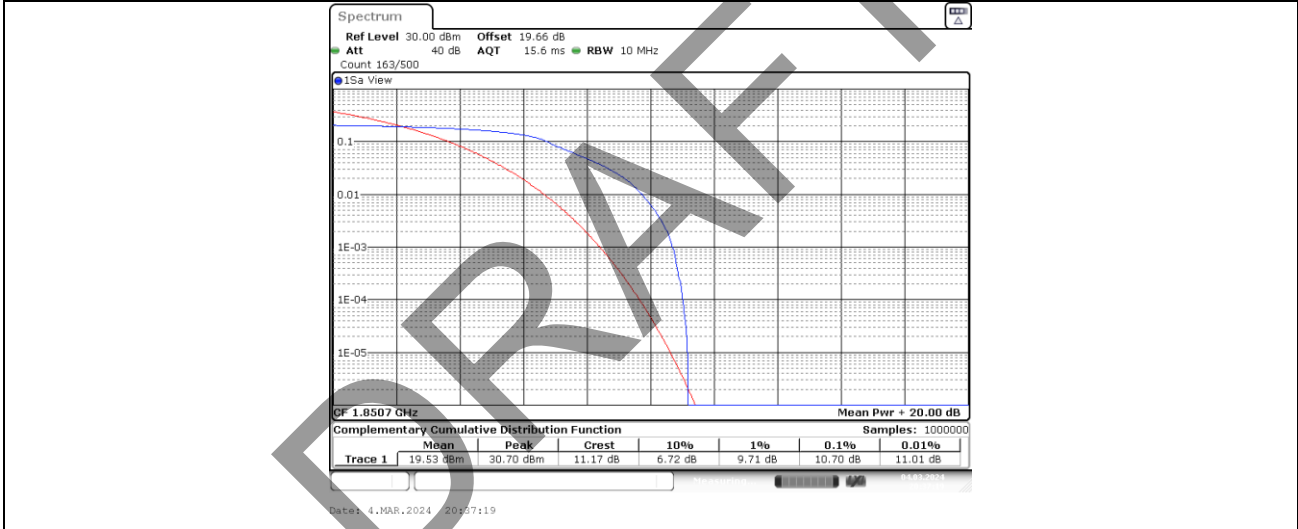

Band25-1.4MHz-QPSK-26047-6-0-Low-10.70-<=13-PASS

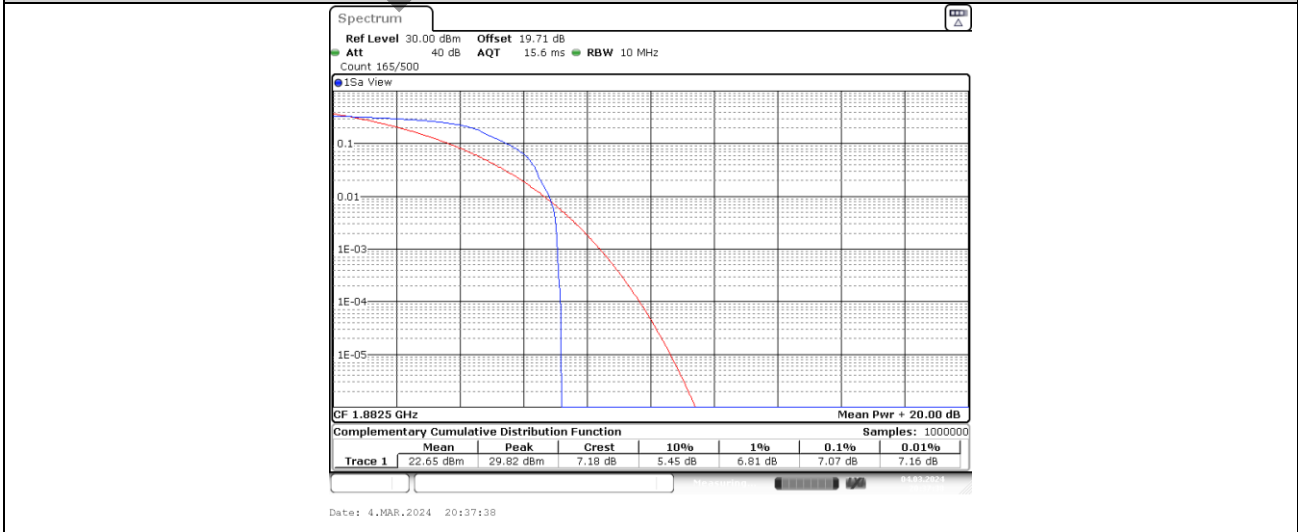



BUREAU VERITAS

Test Report No.: W7L-P23120015R102

Band25-1.4MHz-QPSK-26365-1-0-Low-7.07-<=13-PASS

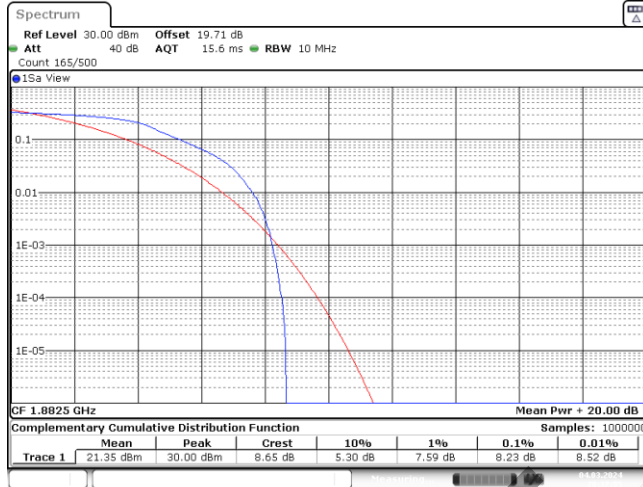

Date: 4.MAR.2024 20:37:55

Band25-1.4MHz-QPSK-26365-6-0-Low-8.23-<=13-PASS

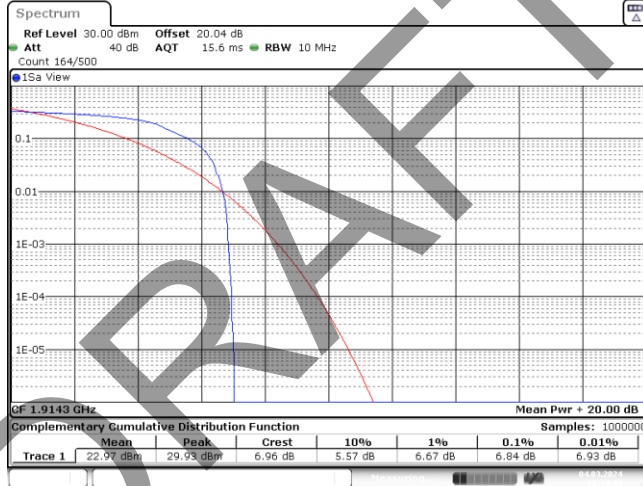

Date: 4.MAR.2024 20:38:40

Band25-1.4MHz-QPSK-26683-1-0-High-6.84-<=13-PASS

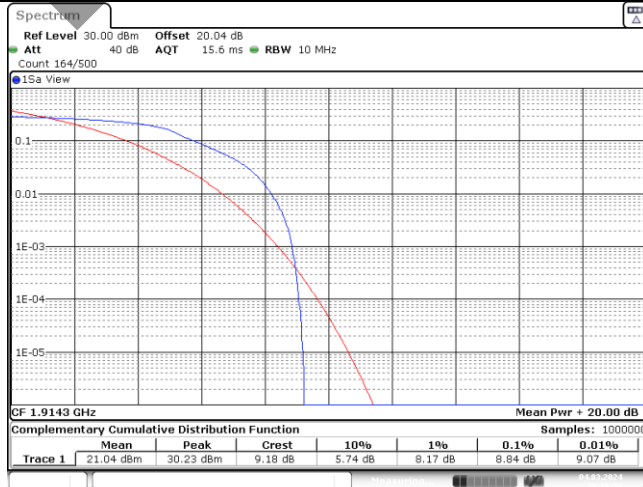

Date: 4.MAR.2024 20:38:57



BUREAU VERITAS

Test Report No.: W7L-P23120015R102

Band25-1.4MHz-QPSK-26683-6-0-High-8.84-<=13-PASS

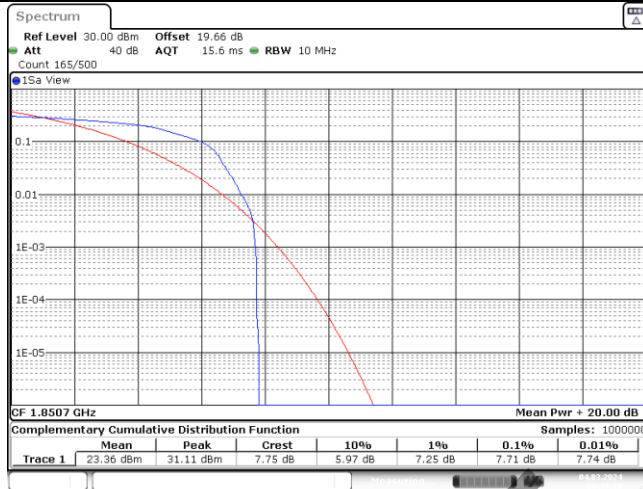

Date: 4.MAR.2024 20:37:11

Band25-1.4MHz-16QAM-26047-1-0-Low-7.71-<=13-PASS

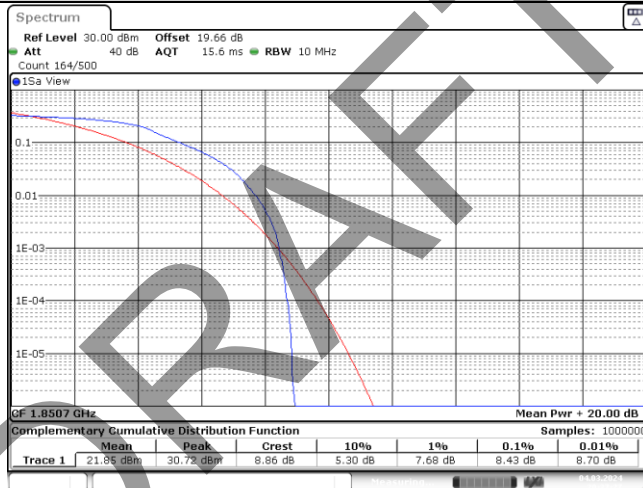

Date: 4.MAR.2024 20:37:28

Band25-1.4MHz-16QAM-26047-6-0-Low-8.43-<=13-PASS

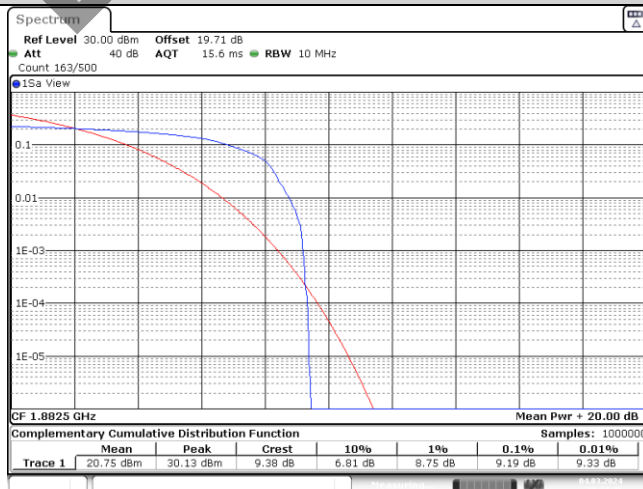

Date: 4.MAR.2024 20:37:47

BV 7Layers Communications Technology (Shenzhen) Co., Ltd

Room B37, Warehouse A5, No.3 Chiwan 4th Road, Zhaoshang Street, Nanshan District Shenzhen, Guangdong, People's Republic of China

Tel: +86 755 8869 6566
Fax: +86 755 8869 6577
Email: customerservice.sw@bureauveritas.com



BUREAU VERITAS

Test Report No.: W7L-P23120015R102

Band25-1.4MHz-16QAM-26365-1-0-Low-9.19-<=13-PASS

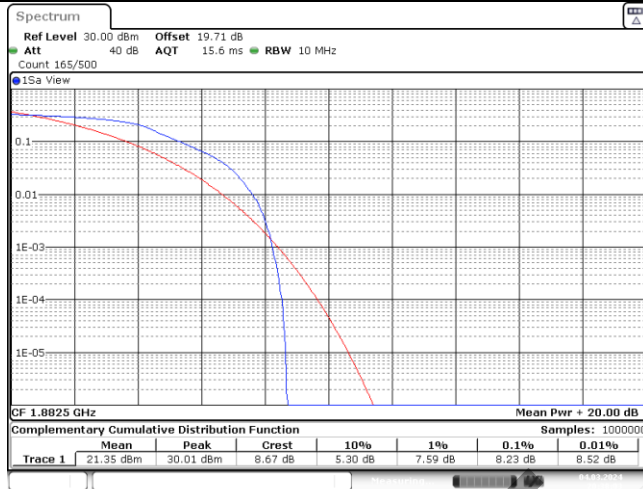

Date: 4.MAR.2024 20:38:04

Band25-1.4MHz-16QAM-26365-6-0-Low-8.23-<=13-PASS

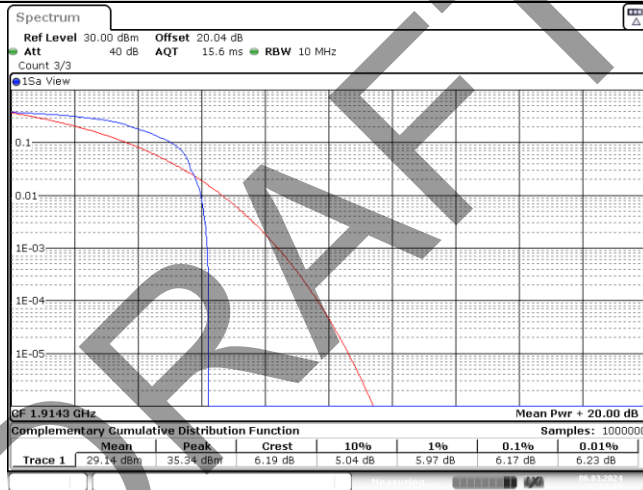

Date: 6.MAR.2024 13:56:15

Band25-1.4MHz-16QAM-26683-1-0-High-6.17-<=13-PASS

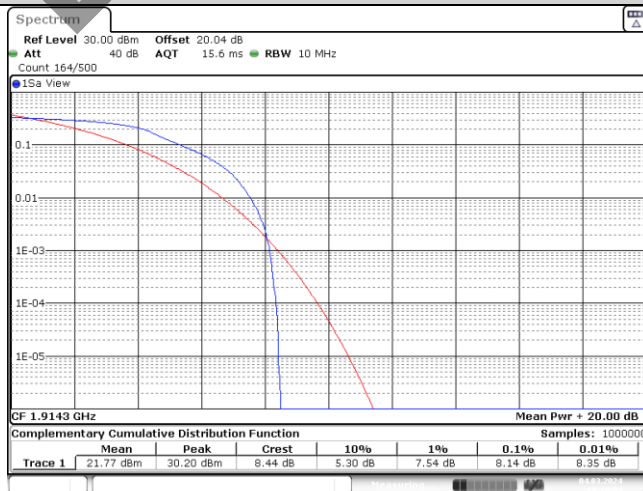

Date: 4.MAR.2024 20:39:05



BUREAU VERITAS

Test Report No.: W7L-P23120015R102

Band25-1.4MHz-16QAM-26683-6-0-High-8.14-<=13-PASS

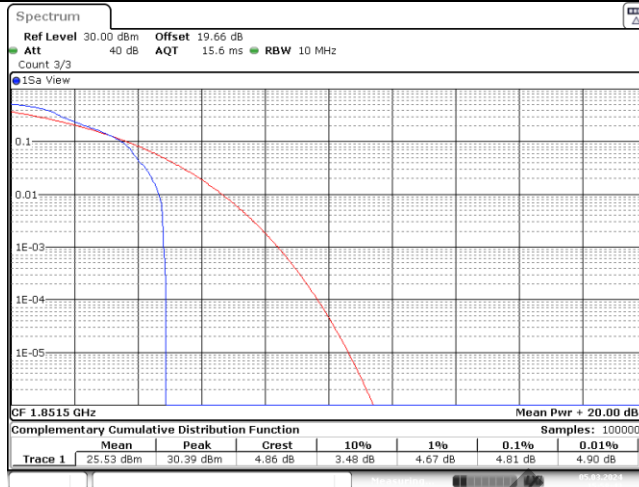

Date: 5.MAR.2024 15:58:43

Band25-3MHz-QPSK-26055-1-0-Low-4.81-<=13-PASS

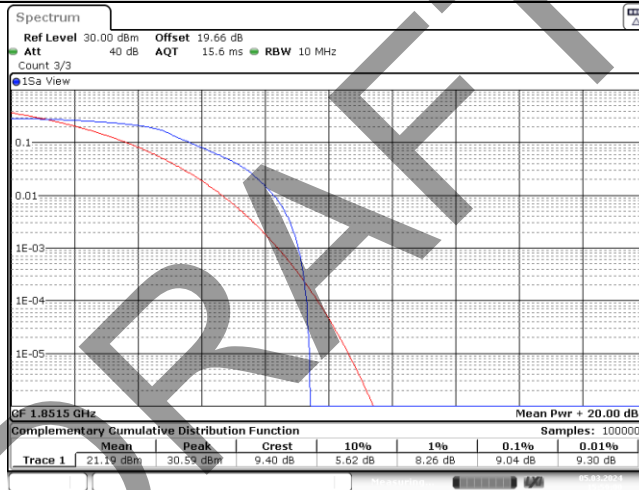

Date: 5.MAR.2024 15:59:00

Band25-3MHz-QPSK-26055-6-0-Low-9.04-<=13-PASS

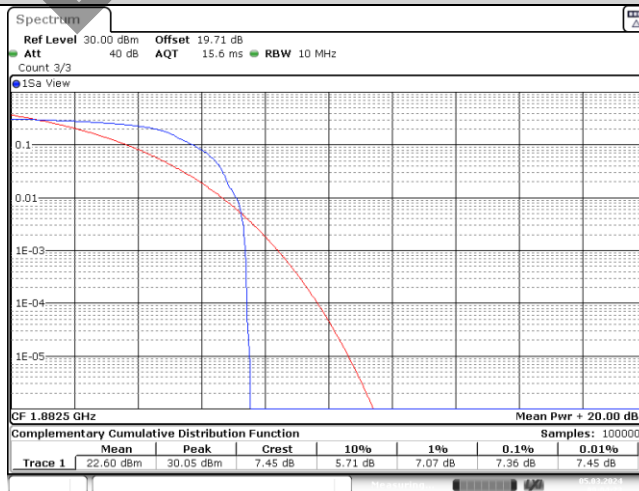

Date: 5.MAR.2024 09:04:23

BV 7Layers Communications Technology (Shenzhen) Co., Ltd

Room B37, Warehouse A5, No.3 Chiwan 4th Road, Zhaoshang Street, Nanshan District Shenzhen, Guangdong, People's Republic of China

Tel: +86 755 8869 6566 Fax: +86 755 8869 6577

Email: customerservice.sw@bureauveritas.com



BUREAU VERITAS

Test Report No.: W7L-P23120015R102

Band25-3MHz-QPSK-26365-1-0-Low-7.36-<=13-PASS



Date: 5.MAR.2024 09:04:40

Band25-3MHz-QPSK-26365-6-0-Low-10.81-<=13-PASS

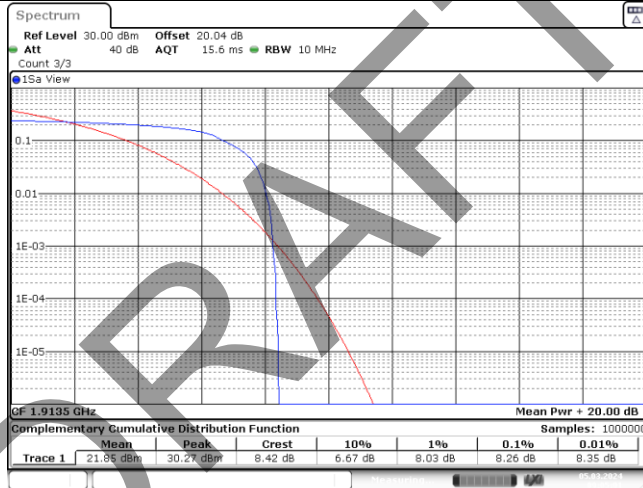

Date: 5.MAR.2024 09:05:00

Band25-3MHz-QPSK-26675-1-0-High-8.26-<=13-PASS

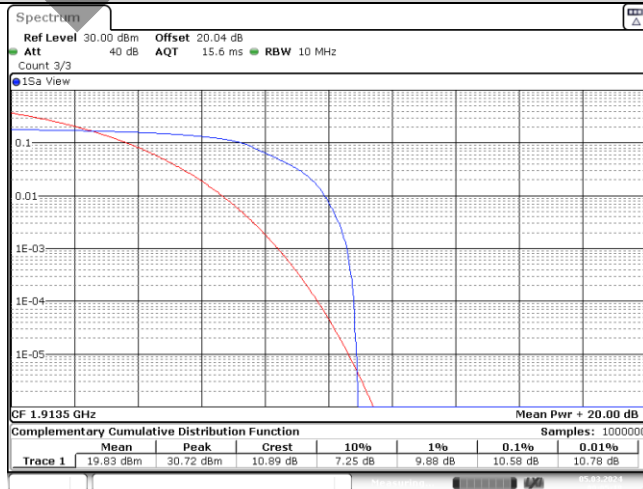

Date: 5.MAR.2024 09:05:18

BV 7Layers Communications Technology (Shenzhen) Co., Ltd

Room B37, Warehouse A5, No.3 Chiwan 4th Road, Zhaoshang Street, Nanshan District Shenzhen, Guangdong, People's Republic of China

Tel: +86 755 8869 6566

Fax: +86 755 8869 6577

Email: customerservice.sw@bureauveritas.com



BUREAU VERITAS

Test Report No.: W7L-P23120015R102

Band25-3MHz-QPSK-26675-6-0-High-10.58-<=13-PASS

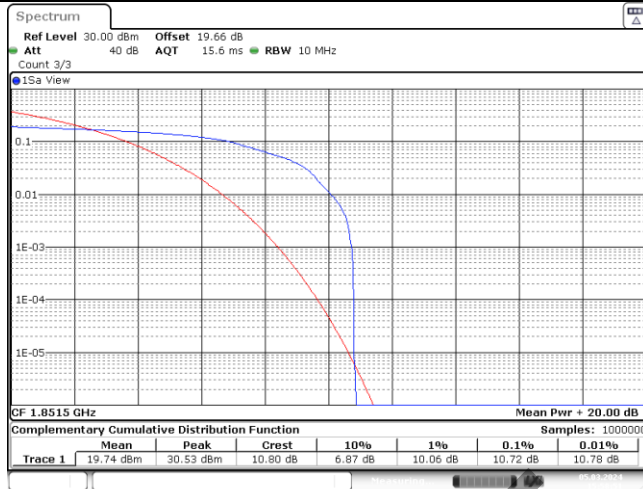

Date: 5.MAR.2024 15:58:51

Band25-3MHz-16QAM-26055-1-0-Low-10.72-<=13-PASS

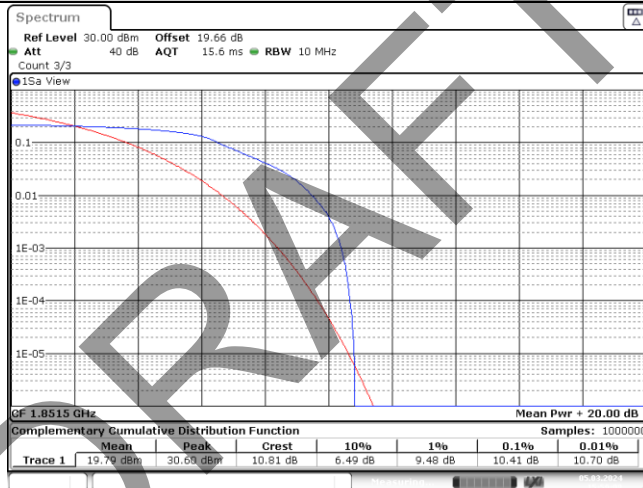

Date: 5.MAR.2024 15:59:08

Band25-3MHz-16QAM-26055-6-0-Low-10.41-<=13-PASS

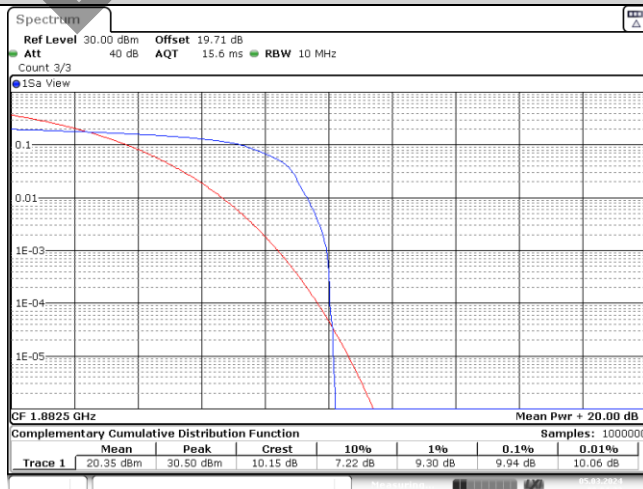

Date: 5.MAR.2024 09:04:32

BV 7Layers Communications Technology (Shenzhen) Co., Ltd

Room B37, Warehouse A5, No.3 Chiwan 4th Road, Zhaoshang Street, Nanshan District Shenzhen, Guangdong, People's Republic of China

Tel: +86 755 8869 6566

Fax: +86 755 8869 6577

Email: customerservice.sw@bureauveritas.com



BUREAU VERITAS

Test Report No.: W7L-P23120015R102

Band25-3MHz-16QAM-26365-1-0-Low-9.94-<=13-PASS

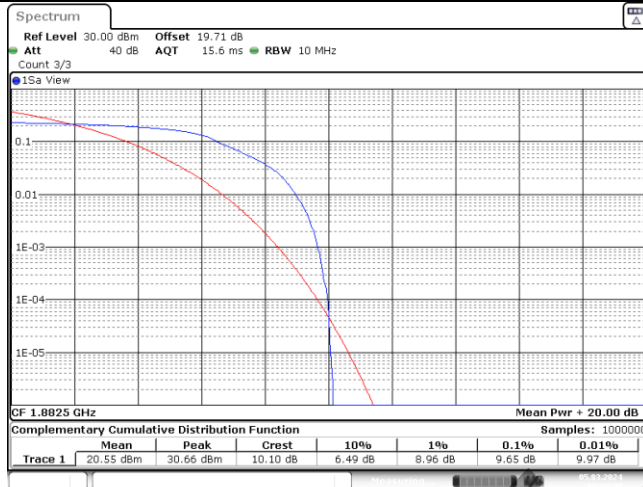

Date: 5.MAR.2024 09:04:49

Band25-3MHz-16QAM-26365-6-0-Low-9.65-<=13-PASS

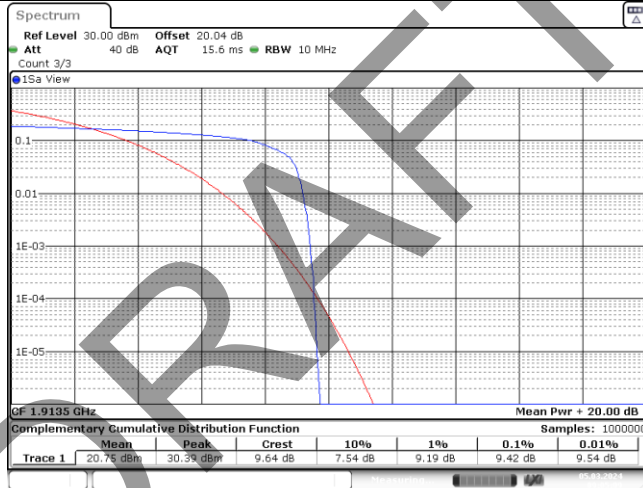

Date: 5.MAR.2024 09:05:09

Band25-3MHz-16QAM-26675-1-0-High-9.42-<=13-PASS

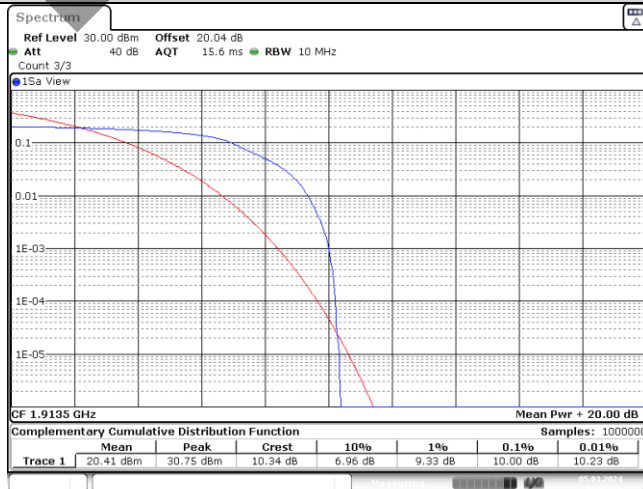

Date: 5.MAR.2024 09:05:26



BUREAU VERITAS

Test Report No.: W7L-P23120015R102

Band25-3MHz-16QAM-26675-6-0-High-10.00-<=13-PASS

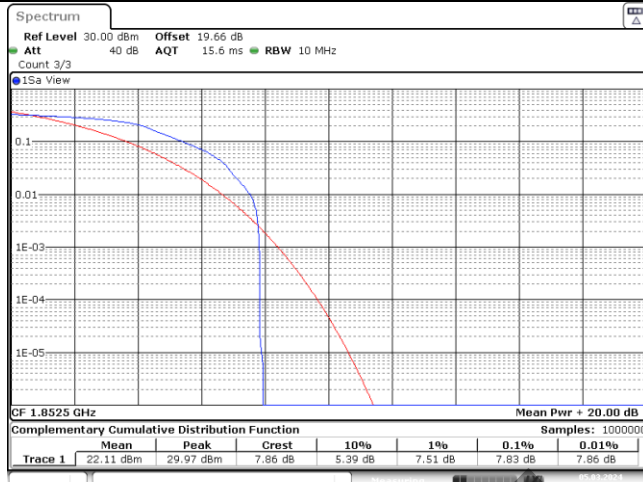

Date: 5.MAR.2024 16:01:21

Band25-5MHz-QPSK-26065-1-0-Low-7.83-<=13-PASS

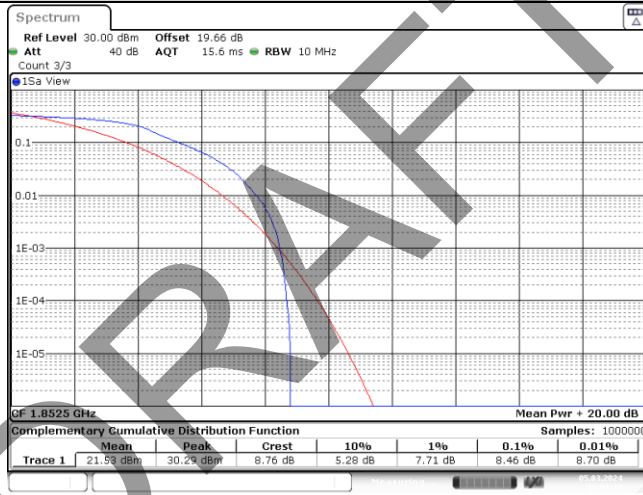

Date: 5.MAR.2024 16:01:39

Band25-5MHz-QPSK-26065-6-0-Low-8.46-<=13-PASS

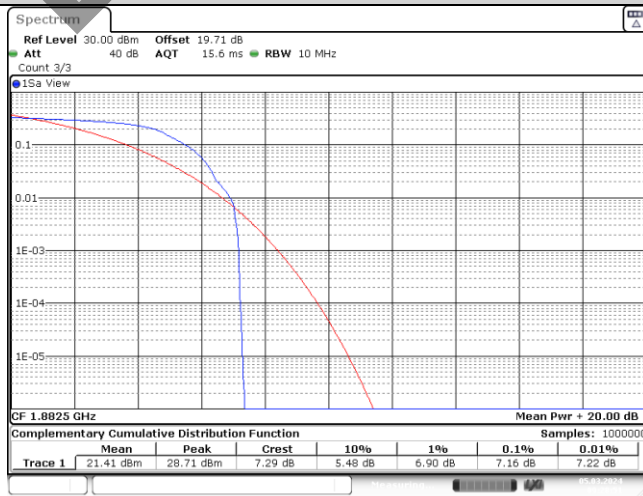

Date: 5.MAR.2024 09:28:51

BV 7Layers Communications Technology (Shenzhen) Co., Ltd

Room B37, Warehouse A5, No.3 Chiwan 4th Road, Zhaoshang Street, Nanshan District Shenzhen, Guangdong, People's Republic of China

Tel: +86 755 8869 6566 Fax: +86 755 8869 6577

Email: customerservice.sw@bureauveritas.com



BUREAU VERITAS

Test Report No.: W7L-P23120015R102

Band25-5MHz-QPSK-26365-1-0-Low-7.16-<=13-PASS

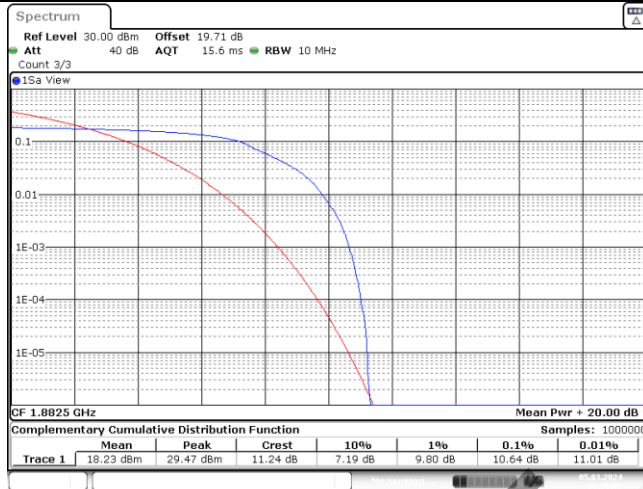

Date: 5.MAR.2024 09:29:08

Band25-5MHz-QPSK-26365-6-0-Low-10.64-<=13-PASS

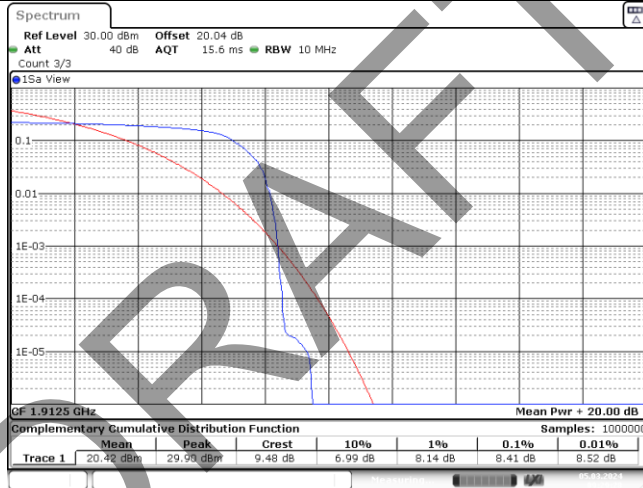

Date: 5.MAR.2024 09:29:28

Band25-5MHz-QPSK-26665-1-0-High-8.41-<=13-PASS

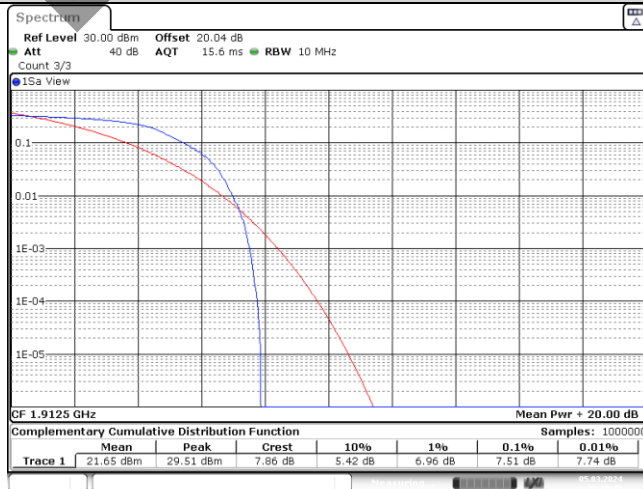

Date: 5.MAR.2024 09:29:45



BUREAU VERITAS

Test Report No.: W7L-P23120015R102

Band25-5MHz-QPSK-26665-6-0-High-7.51-<=13-PASS



Date: 5.MAR.2024 16:01:30

Band25-5MHz-16QAM-26065-1-0-Low-7.88-<=13-PASS

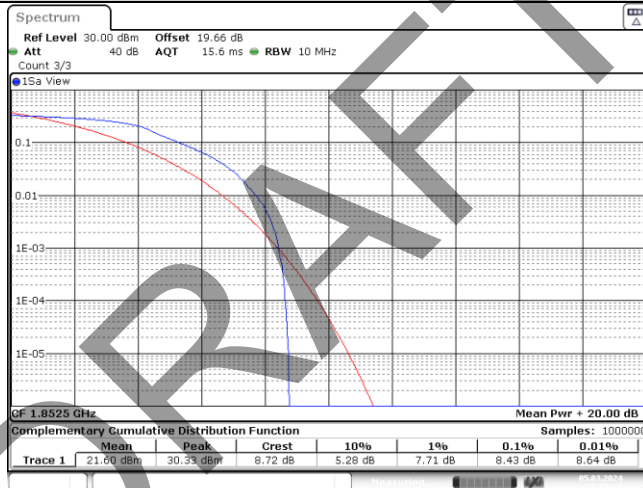

Date: 5.MAR.2024 16:01:47

Band25-5MHz-16QAM-26065-6-0-Low-8.43-<=13-PASS

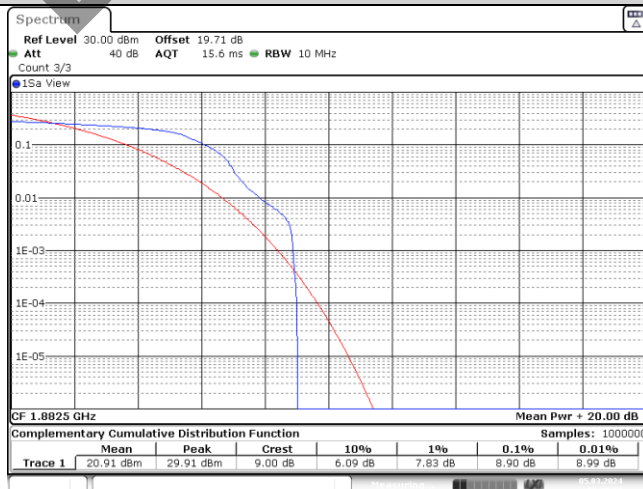

Date: 5.MAR.2024 09:28:59



BUREAU VERITAS

Test Report No.: W7L-P23120015R102

Band25-5MHz-16QAM-26365-1-0-Low-8.90-<=13-PASS

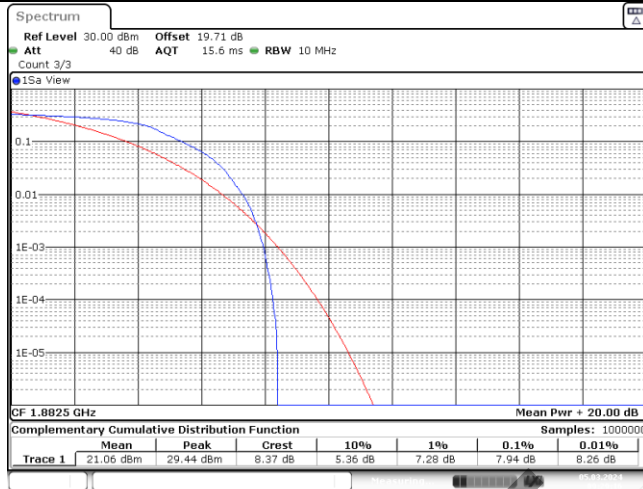

Date: 5.MAR.2024 09:29:16

Band25-5MHz-16QAM-26365-6-0-Low-7.94-<=13-PASS

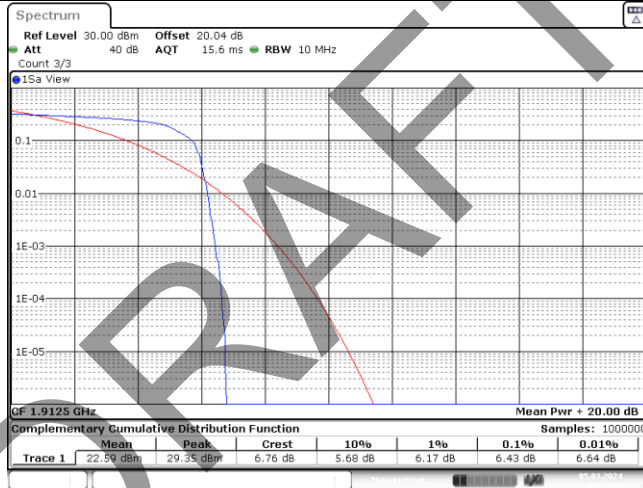

Date: 5.MAR.2024 09:29:36

Band25-5MHz-16QAM-26665-1-0-High-6.43-<=13-PASS

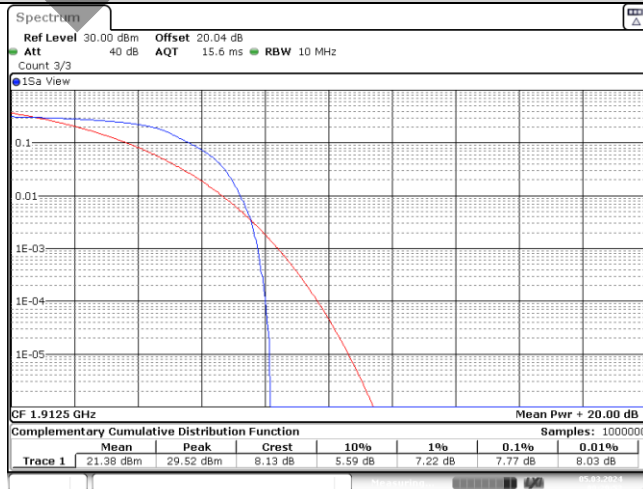

Date: 5.MAR.2024 09:29:53



BUREAU VERITAS

Test Report No.: W7L-P23120015R102

Band25-5MHz-16QAM-26665-6-0-High-7.77-<=13-PASS

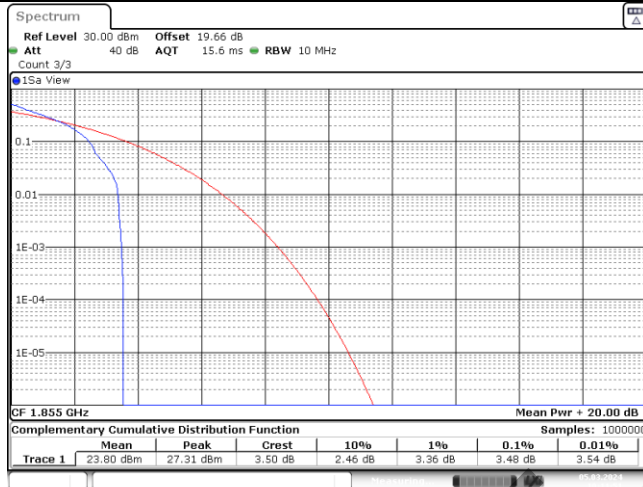

Date: 5.MAR.2024 10:11:51

Band25-10MHz-QPSK-26090-1-0-Low-3.48-<=13-PASS

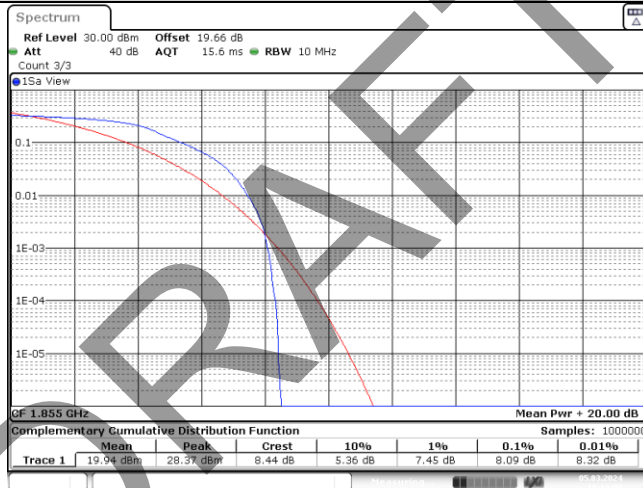

Date: 5.MAR.2024 10:12:08

Band25-10MHz-QPSK-26090-6-0-Low-8.09-<=13-PASS

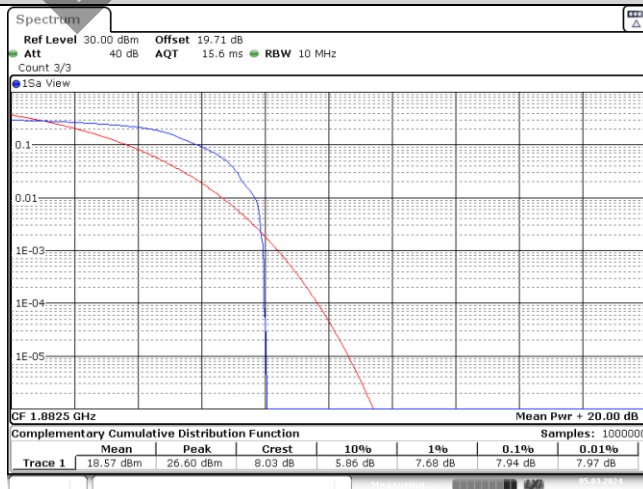

Date: 5.MAR.2024 10:12:27



BUREAU VERITAS

Test Report No.: W7L-P23120015R102

Band25-10MHz-QPSK-26365-1-0-Low-7.94-<=13-PASS

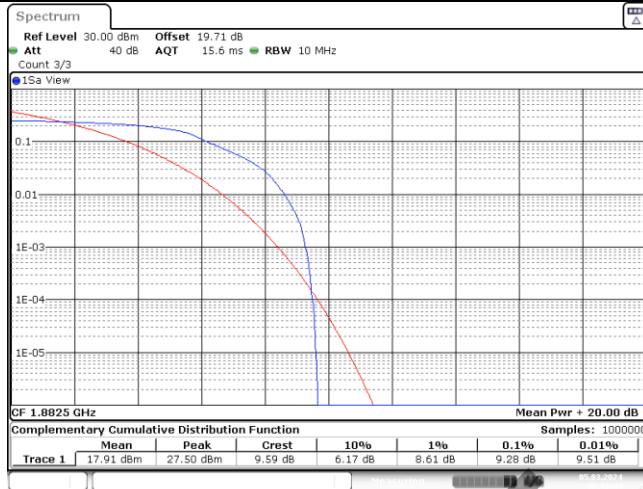

Date: 5.MAR.2024 10:12:44

Band25-10MHz-QPSK-26365-6-0-Low-9.28-<=13-PASS

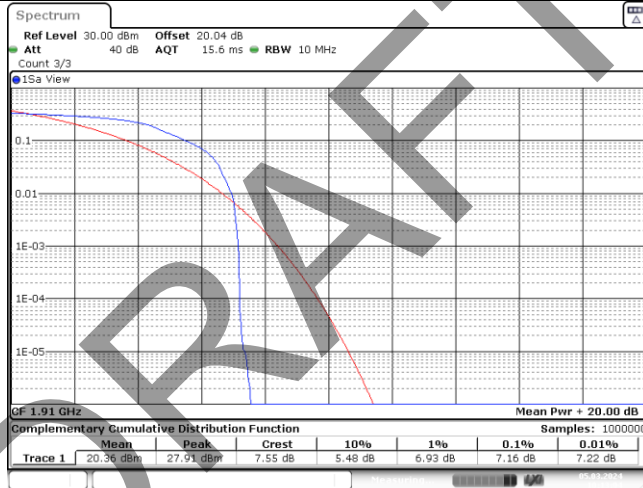

Date: 5.MAR.2024 10:13:04

Band25-10MHz-QPSK-26640-1-0-High-7.16-<=13-PASS

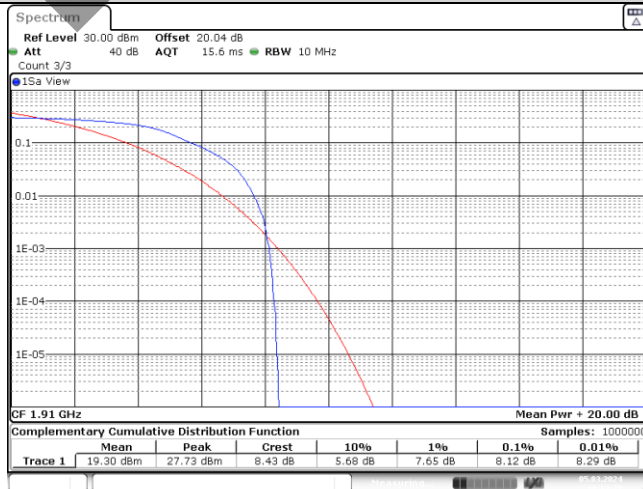

Date: 5.MAR.2024 10:13:22



BUREAU VERITAS

Test Report No.: W7L-P23120015R102

Band25-10MHz-QPSK-26640-6-0-High-8.12-<=13-PASS

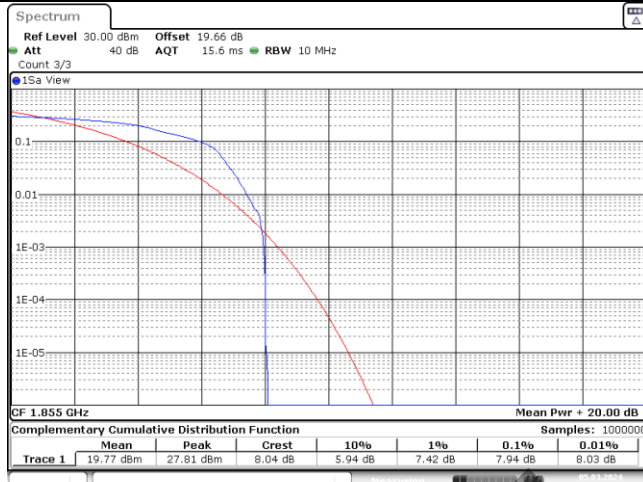

Date: 5.MAR.2024 10:11:59

Band25-10MHz-16QAM-26090-1-0-Low-7.94-<=13-PASS

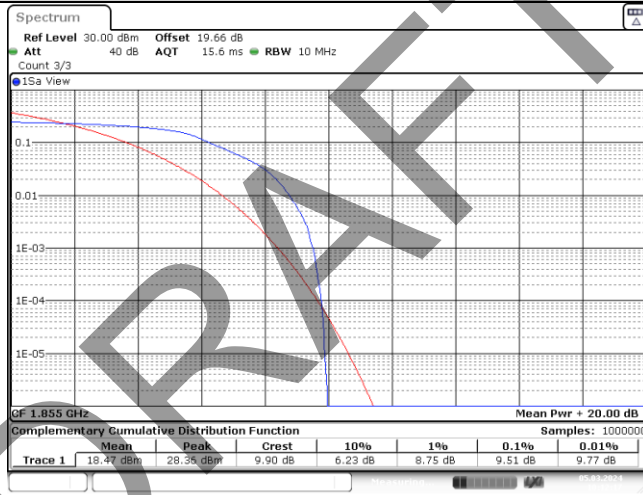

Date: 5.MAR.2024 10:12:17

Band25-10MHz-16QAM-26090-6-0-Low-9.51-<=13-PASS

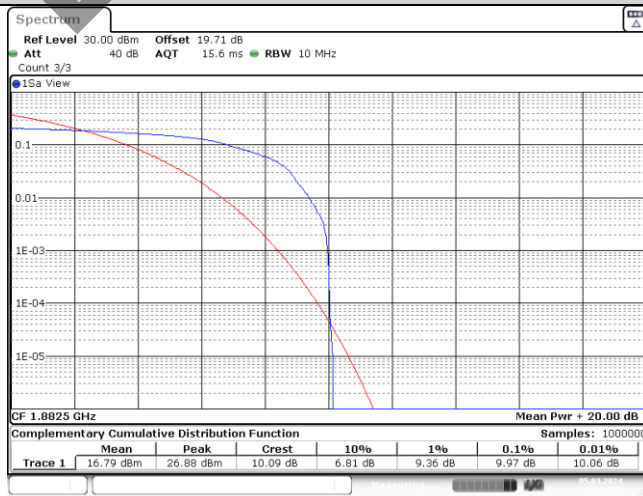

Date: 5.MAR.2024 10:12:36



BUREAU VERITAS

Test Report No.: W7L-P23120015R102

Band25-10MHz-16QAM-26365-1-0-Low-9.97-<=13-PASS

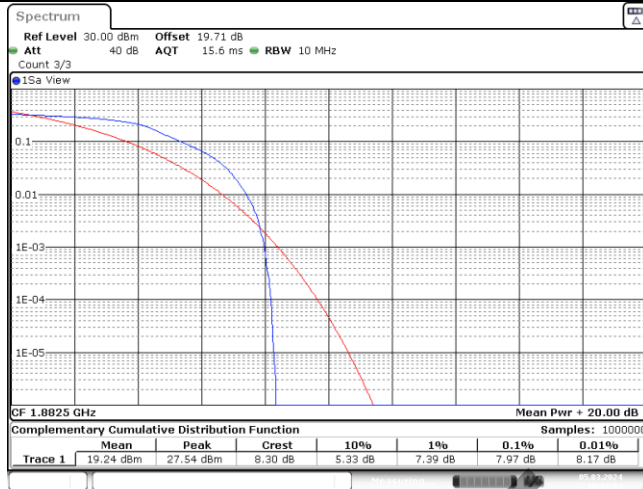

Date: 5.MAR.2024 10:12:53

Band25-10MHz-16QAM-26365-6-0-Low-7.97-<=13-PASS

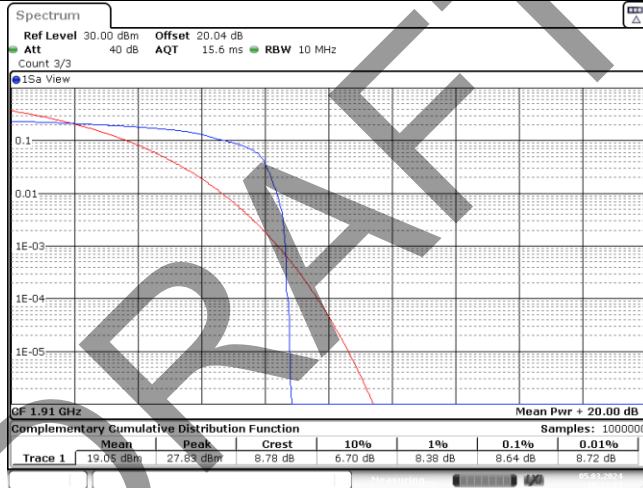

Date: 5.MAR.2024 10:13:13

Band25-10MHz-16QAM-26640-1-0-High-8.64-<=13-PASS

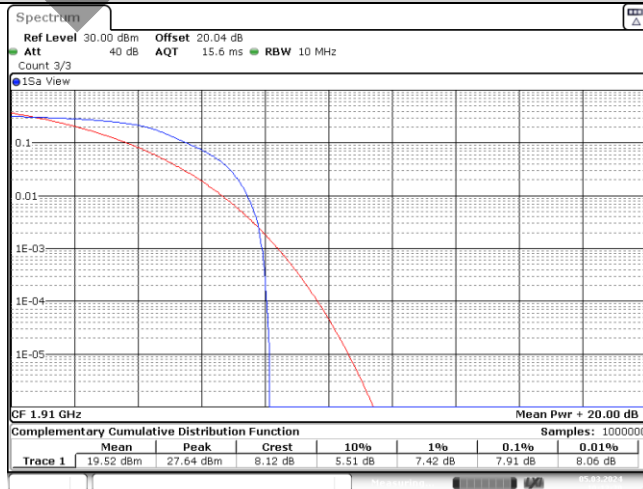

Date: 5.MAR.2024 10:13:30



BUREAU VERITAS

Test Report No.: W7L-P23120015R102

Band25-10MHz-16QAM-26640-6-0-High-7.91-<=13-PASS

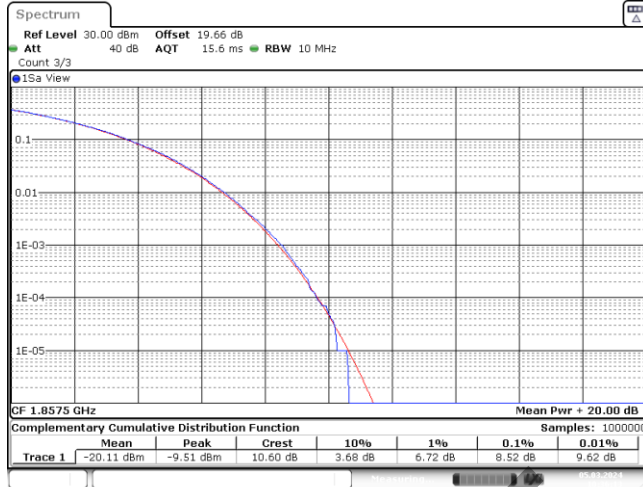

Date: 5.MAR.2024 10:36:13

Band25-15MHz-QPSK-26115-1-0-Low-8.52-<=13-PASS

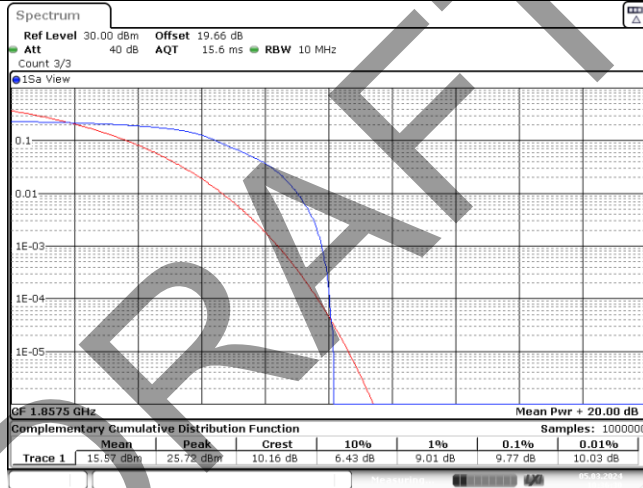

Date: 5.MAR.2024 10:36:31

Band25-15MHz-QPSK-26115-6-0-Low-9.77-<=13-PASS

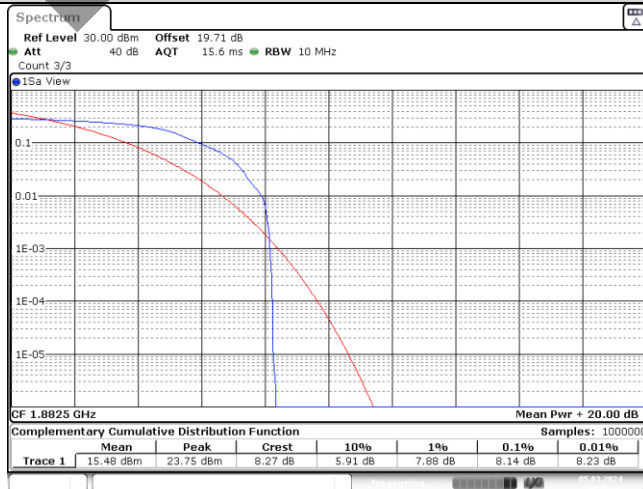

Date: 5.MAR.2024 10:36:50



BUREAU VERITAS

Test Report No.: W7L-P23120015R102

Band25-15MHz-QPSK-26365-1-0-Low-8.14-<=13-PASS

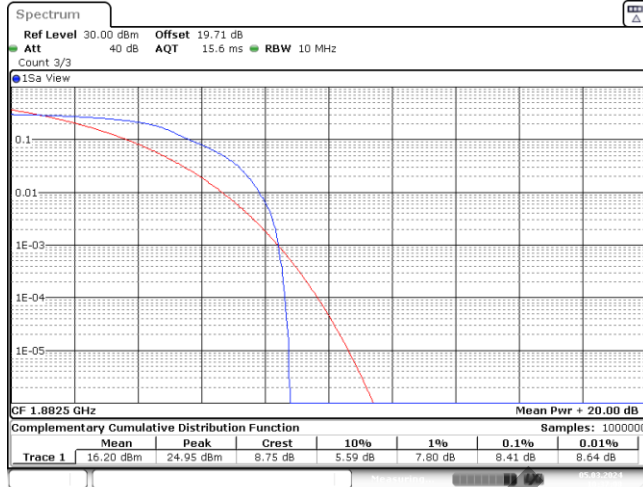

Date: 5.MAR.2024 10:37:08

Band25-15MHz-QPSK-26365-6-0-Low-8.41-<=13-PASS

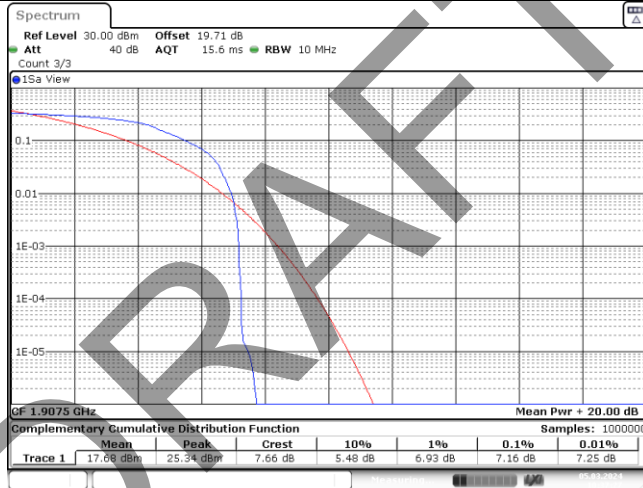

Date: 5.MAR.2024 10:37:12

Band25-15MHz-QPSK-26615-1-0-High-7.16-<=13-PASS

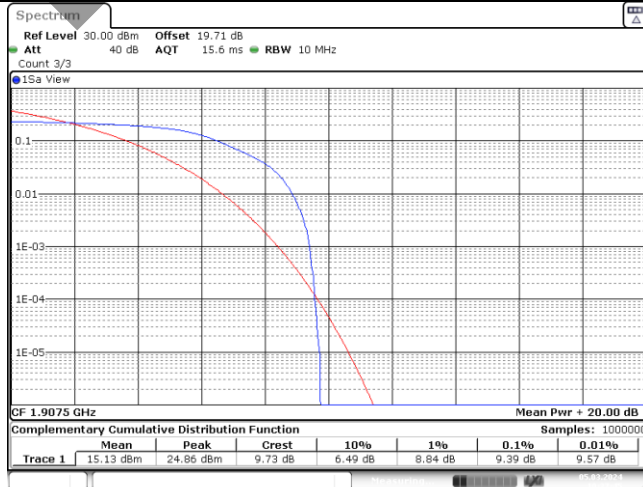

Date: 5.MAR.2024 10:37:45



BUREAU VERITAS

Test Report No.: W7L-P23120015R102

Band25-15MHz-QPSK-26615-6-0-High-9.39-<=13-PASS

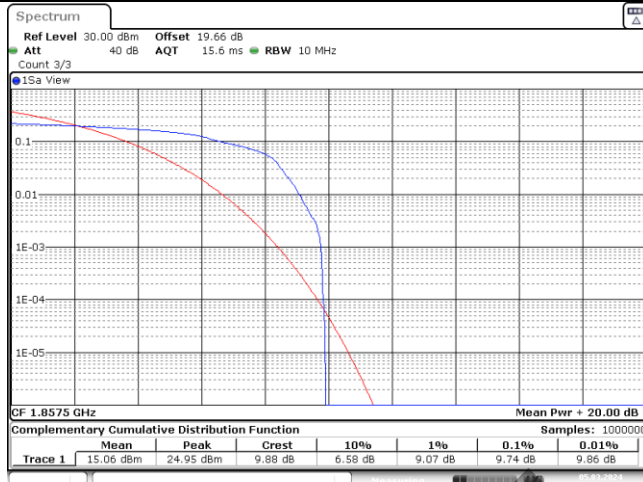

Date: 5.MAR.2024 10:36:22

Band25-15MHz-16QAM-26115-1-0-Low-9.74-<=13-PASS

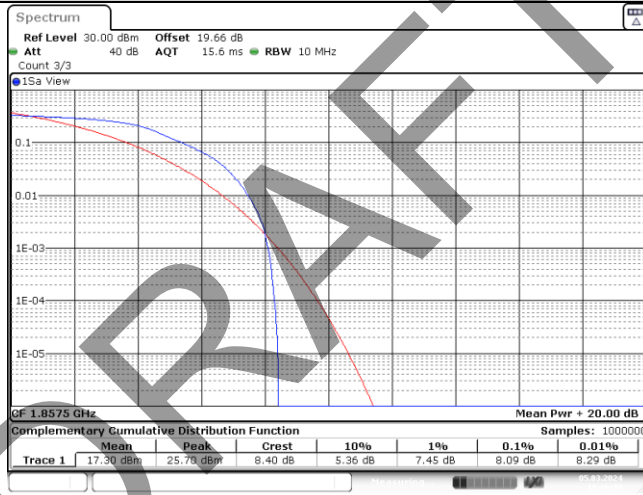

Date: 5.MAR.2024 10:36:40

Band25-15MHz-16QAM-26115-6-0-Low-8.09-<=13-PASS

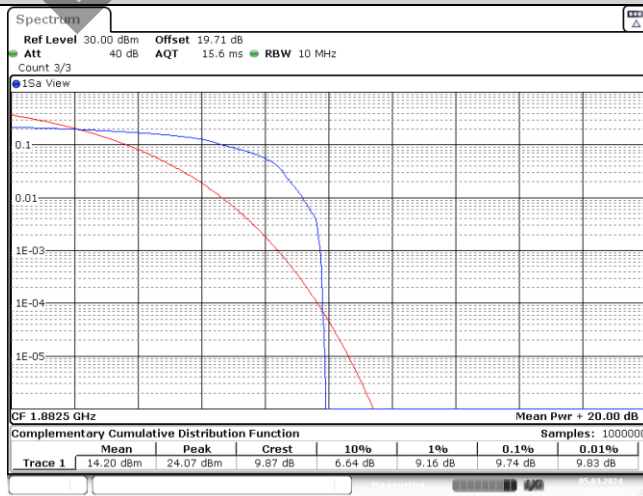

Date: 5.MAR.2024 10:36:59



BUREAU VERITAS

Test Report No.: W7L-P23120015R102

Band25-15MHz-16QAM-26365-1-0-Low-9.74-<=13-PASS



Date: 5.MAR.2024 10:37:17

Band25-15MHz-16QAM-26365-6-0-Low-10.93-<=13-PASS

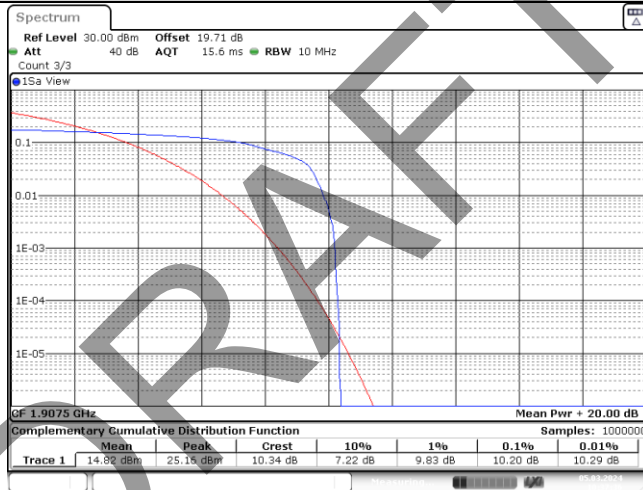

Date: 5.MAR.2024 10:37:36

Band25-15MHz-16QAM-26615-1-0-High-10.20-<=13-PASS

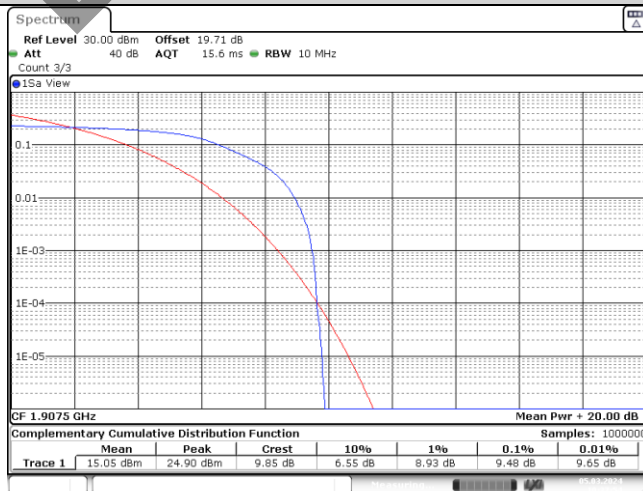

Date: 5.MAR.2024 10:37:54



BUREAU VERITAS

Test Report No.: W7L-P23120015R102

Band25-15MHz-16QAM-26615-6-0-High-9.48-<=13-PASS

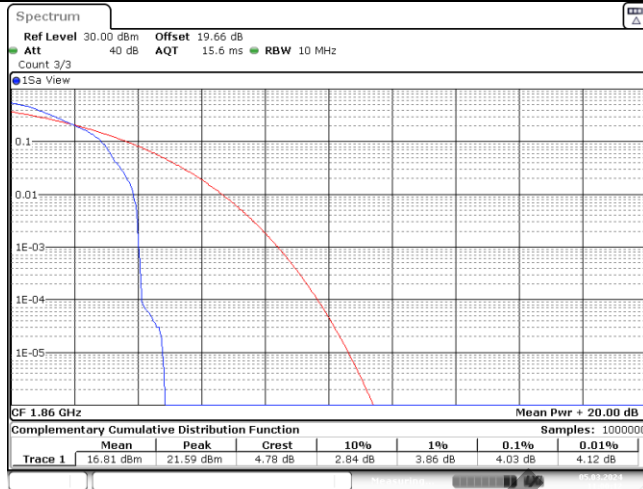

Date: 5.MAR.2024 11:00:12

Band25-20MHz-QPSK-26140-1-0-Low-4.03-<=13-PASS

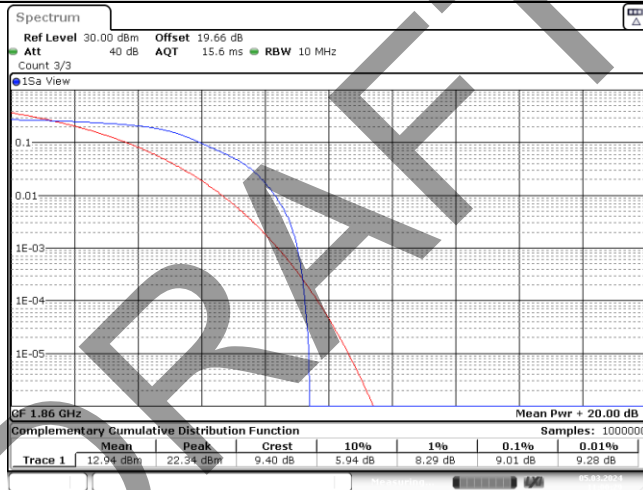

Date: 5.MAR.2024 11:00:30

Band25-20MHz-QPSK-26140-6-0-Low-9.01-<=13-PASS

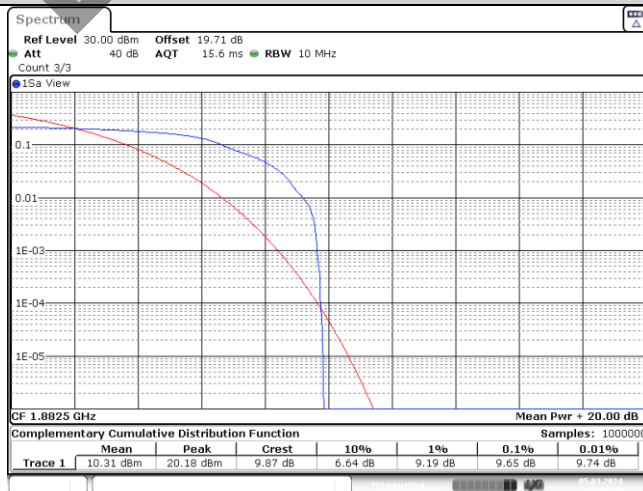

Date: 5.MAR.2024 11:00:49



BUREAU VERITAS

Test Report No.: W7L-P23120015R102

Band25-20MHz-QPSK-26365-1-0-Low-9.65-<=13-PASS

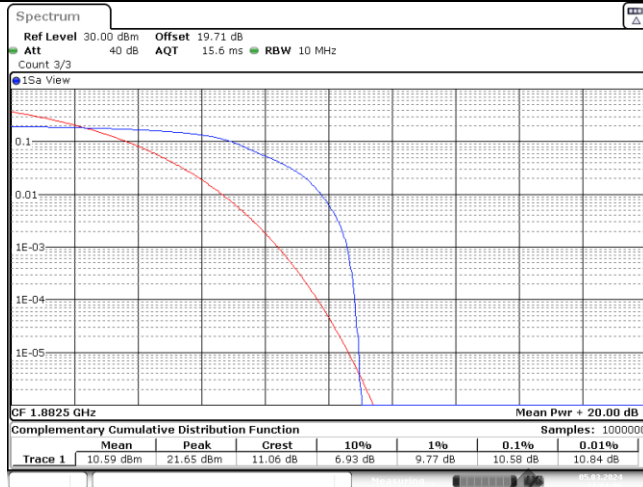

Date: 5.MAR.2024 11:01:07

Band25-20MHz-QPSK-26365-6-0-Low-10.58-<=13-PASS

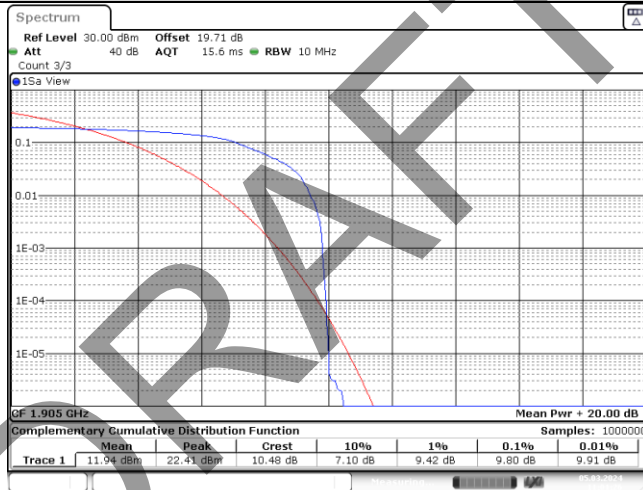

Date: 5.MAR.2024 11:01:26

Band25-20MHz-QPSK-26590-1-0-High-9.80-<=13-PASS

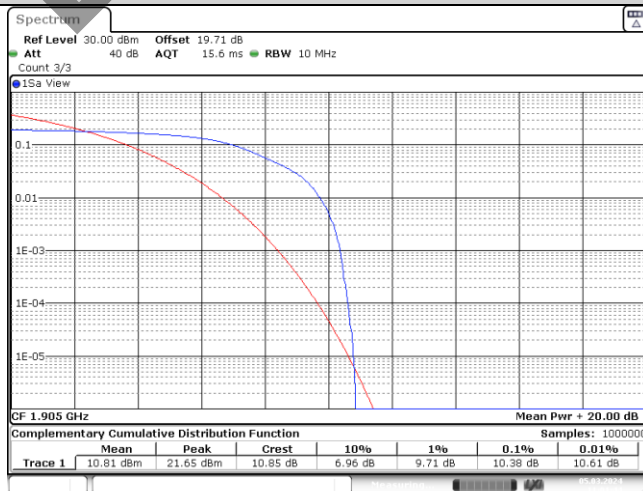

Date: 5.MAR.2024 11:01:44



BUREAU VERITAS

Test Report No.: W7L-P23120015R102

Band25-20MHz-QPSK-26590-6-0-High-10.38-<=13-PASS

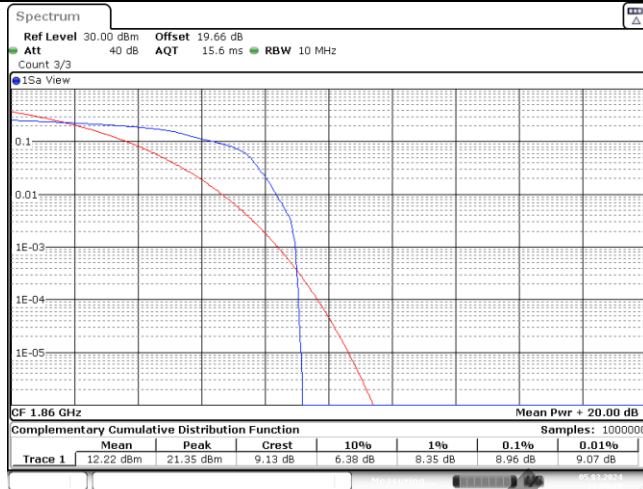

Date: 5.MAR.2024 11:00:21

Band25-20MHz-16QAM-26140-1-0-Low-8.96-<=13-PASS

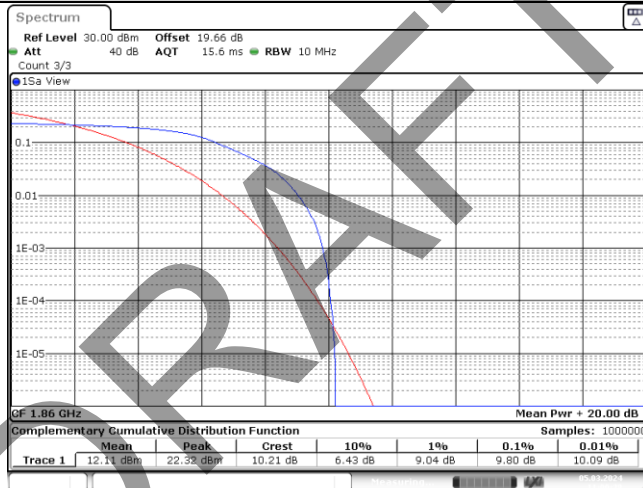

Date: 5.MAR.2024 11:00:38

Band25-20MHz-16QAM-26140-6-0-Low-9.80-<=13-PASS

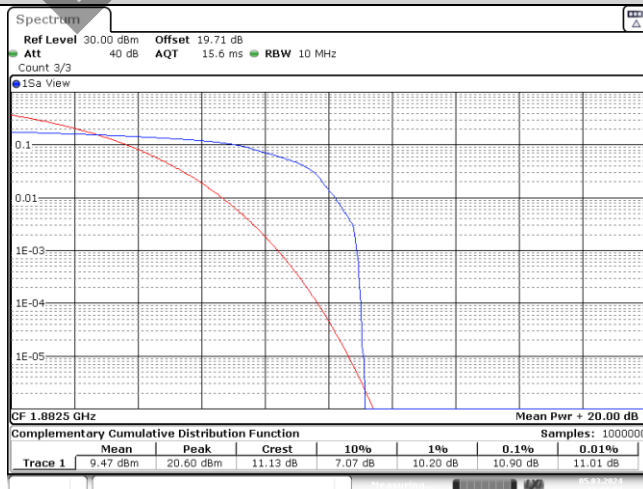

Date: 5.MAR.2024 11:00:58



BUREAU VERITAS

Test Report No.: W7L-P23120015R102

Band25-20MHz-16QAM-26365-1-0-Low-10.90-<=13-PASS

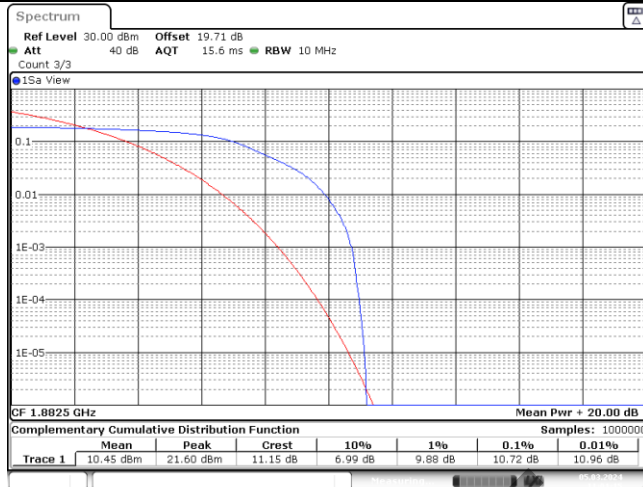

Date: 5.MAR.2024 11:01:16

Band25-20MHz-16QAM-26365-6-0-Low-10.72-<=13-PASS

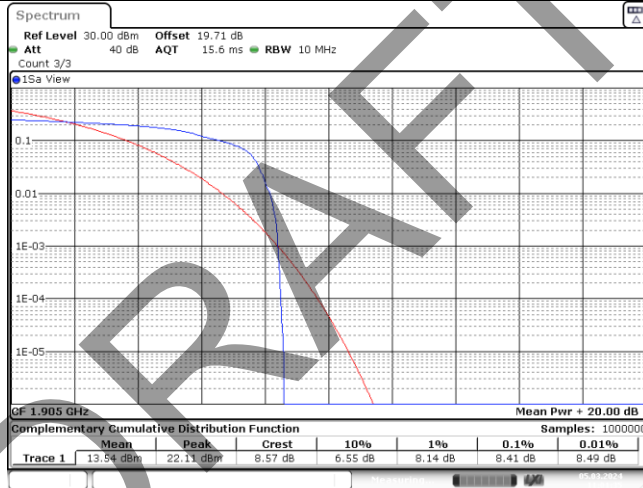

Date: 5.MAR.2024 11:01:35

Band25-20MHz-16QAM-26590-1-0-High-8.41-<=13-PASS

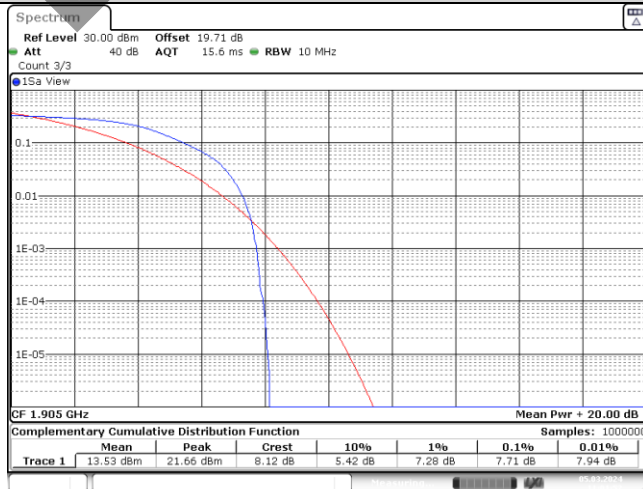

Date: 5.MAR.2024 11:01:53



**BUREAU
VERITAS**

Test Report No.: W7L-P23120015R102

Band25-20MHz-16QAM-26590-6-0-High-7.71-<=13-PASS

26DB BANDWIDTH AND OCCUPIED BANDWIDTH FOR M1 GPRS 1900 TEST RESULT

Band	Channel	Occupied Bandwidth (MHz)	26dB Bandwidth (MHz)	Limit (MHz)	Verdict
GPRS1900	512	0.248	0.31	---	PASS
GPRS1900	661	0.246	0.32	---	PASS
GPRS1900	810	0.244	0.32	---	PASS
EGPRS1900	512	0.237	0.32	---	PASS
EGPRS1900	661	0.237	0.32	---	PASS
EGPRS1900	810	0.238	0.32	---	PASS

GPRS 1900 TEST GRAPHS

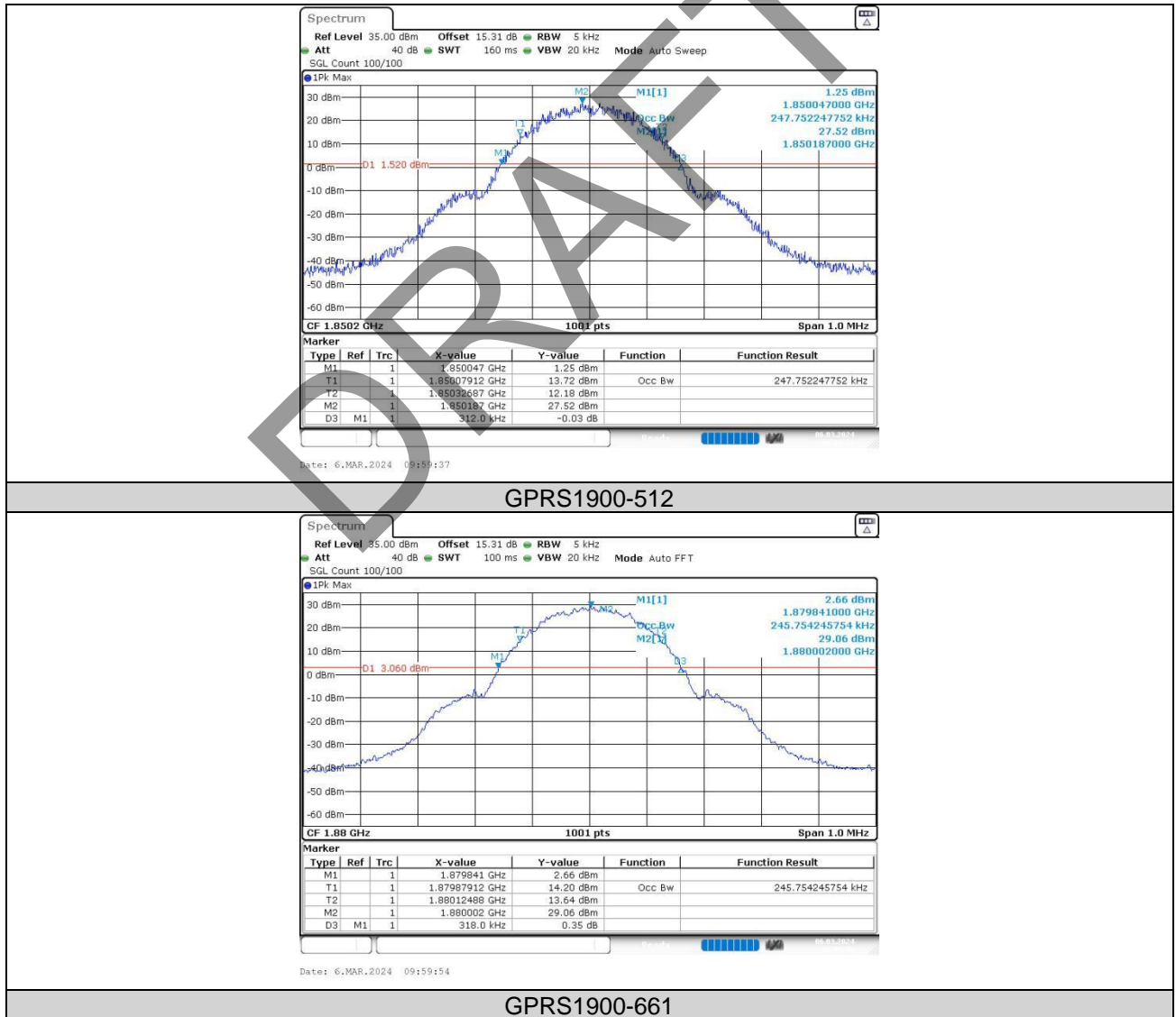



BUREAU VERITAS

Test Report No.: W7L-P23120015R102

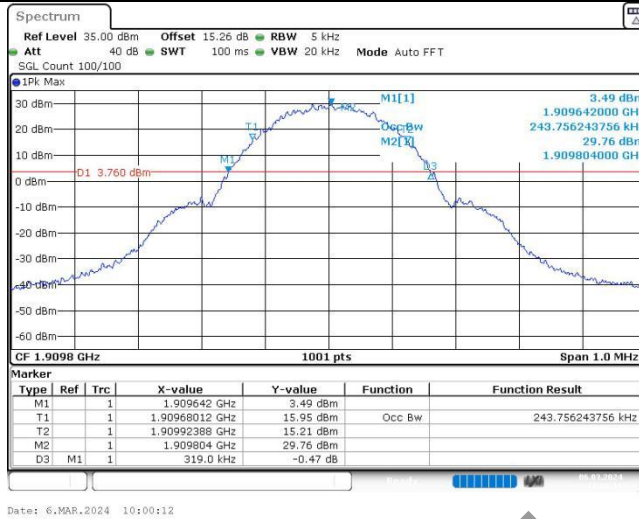

GPRS1900-810



EGPRS1900-512

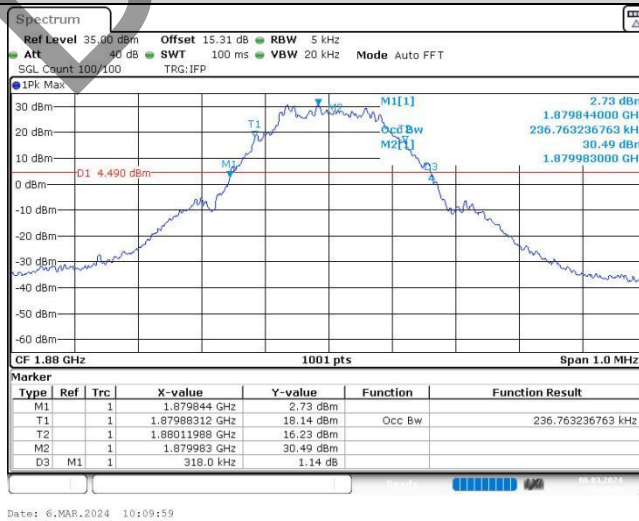

EGPRS1900-661

BV 7Layers Communications Technology (Shenzhen) Co., Ltd

Room B37, Warehouse A5, No.3 Chiwan 4th Road, Zhaoshang Street, Nanshan District Shenzhen, Guangdong, People's Republic of China

Tel: +86 755 8869 6566
Fax: +86 755 8869 6577

Email: customerservice.sw@bureauveritas.com



BUREAU VERITAS

Test Report No.: W7L-P23120015R102

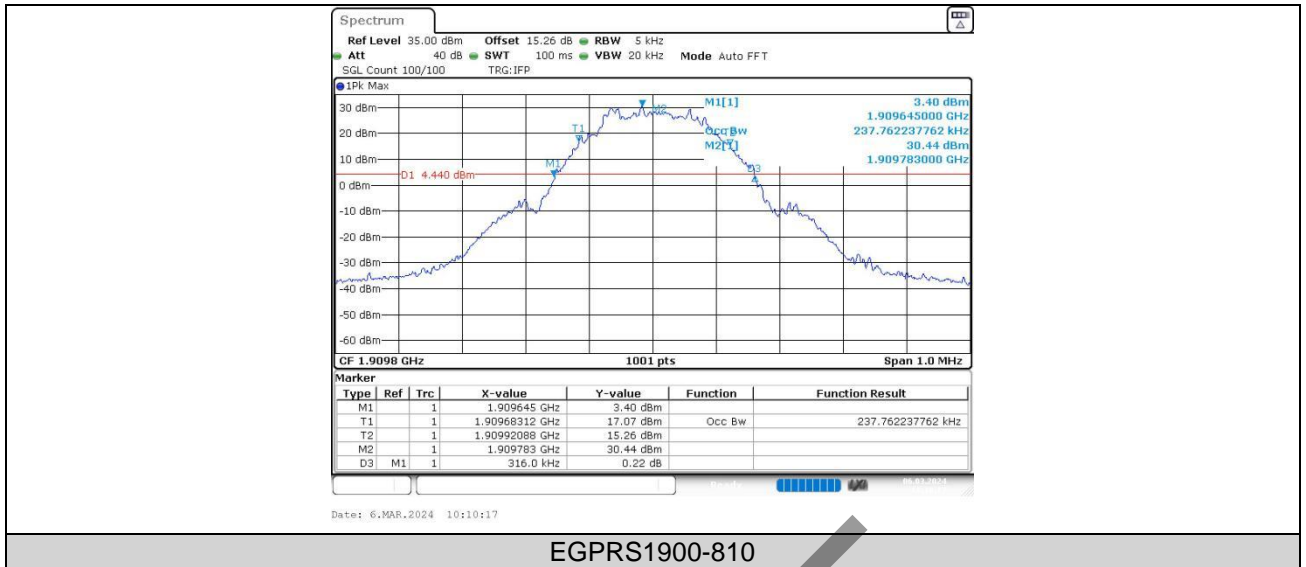

DRAFT



BAND 2 TEST RESULT

Band	Bandwidth	Modulation	Channel	RB Size	RB Start	NB Index	Occupied Bandwidth (MHz)	26dB Bandwidth (MHz)	Verdict
Band2	1.4MHz	18607	QPSK	6	0	Low	1.106	1.356	PASS
Band2	1.4MHz	18900	QPSK	6	0	Low	1.106	1.323	PASS
Band2	1.4MHz	19193	QPSK	6	0	High	1.109	1.344	PASS
Band2	1.4MHz	18607	16QAM	6	0	Low	1.106	1.353	PASS
Band2	1.4MHz	18900	16QAM	6	0	Low	1.106	1.326	PASS
Band2	1.4MHz	19193	16QAM	6	0	High	1.106	1.353	PASS
Band2	3MHz	18615	QPSK	6	0	Low	1.139	1.398	PASS
Band2	3MHz	18900	QPSK	6	0	Low	1.139	1.482	PASS
Band2	3MHz	19185	QPSK	6	0	High	1.145	1.446	PASS
Band2	3MHz	18615	16QAM	6	0	Low	1.139	1.398	PASS
Band2	3MHz	18900	16QAM	6	0	Low	1.145	1.482	PASS
Band2	3MHz	19185	16QAM	6	0	High	1.139	1.446	PASS
Band2	5MHz	18625	QPSK	6	0	Low	1.219	1.670	PASS
Band2	5MHz	18900	QPSK	6	0	Low	1.229	1.540	PASS
Band2	5MHz	19175	QPSK	6	0	High	1.229	2.100	PASS
Band2	5MHz	18625	16QAM	6	0	Low	1.219	1.650	PASS
Band2	5MHz	18900	16QAM	6	0	Low	1.229	1.560	PASS
Band2	5MHz	19175	16QAM	6	0	High	1.229	2.100	PASS
Band2	10MHz	18650	QPSK	6	0	Low	1.439	2.460	PASS
Band2	10MHz	18900	QPSK	6	0	Low	1.578	2.840	PASS
Band2	10MHz	19150	QPSK	6	0	High	1.518	2.840	PASS
Band2	10MHz	18650	16QAM	6	0	Low	1.439	2.420	PASS
Band2	10MHz	18900	16QAM	6	0	Low	1.578	2.860	PASS
Band2	10MHz	19150	16QAM	6	0	High	1.518	2.800	PASS
Band2	15MHz	18675	QPSK	6	0	Low	2.038	3.570	PASS
Band2	15MHz	18900	QPSK	6	0	Low	2.577	4.080	PASS
Band2	15MHz	19125	QPSK	6	0	High	2.428	3.930	PASS
Band2	15MHz	18675	16QAM	6	0	Low	2.008	3.570	PASS
Band2	15MHz	18900	16QAM	6	0	Low	2.607	4.080	PASS
Band2	15MHz	19125	16QAM	6	0	High	2.428	3.960	PASS
Band2	20MHz	18700	QPSK	6	0	Low	3.197	4.920	PASS
Band2	20MHz	18900	QPSK	6	0	Low	4.116	5.640	PASS
Band2	20MHz	19100	QPSK	6	0	High	4.036	5.840	PASS
Band2	20MHz	18700	16QAM	6	0	Low	3.197	4.960	PASS
Band2	20MHz	18900	16QAM	6	0	Low	4.116	5.640	PASS
Band2	20MHz	19100	16QAM	6	0	High	4.036	5.840	PASS



BUREAU VERITAS

Test Report No.: W7L-P23120015R102

BAND 2 TEST GRAPHS

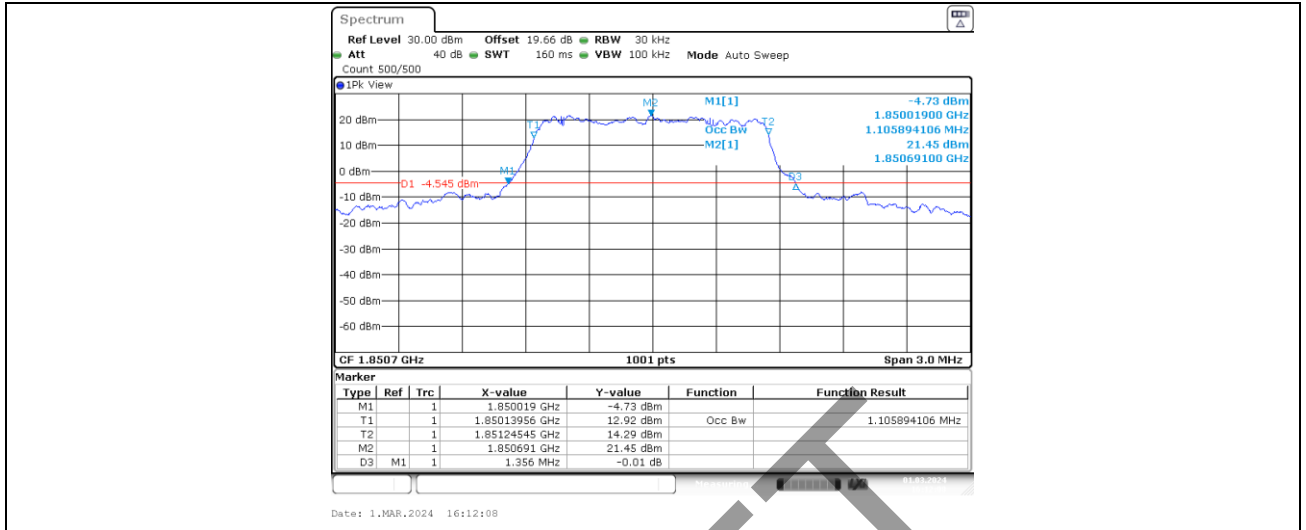

Band2-1.4MHz-QPSK-18607-6-0-Low-1.106-1.356-PASS

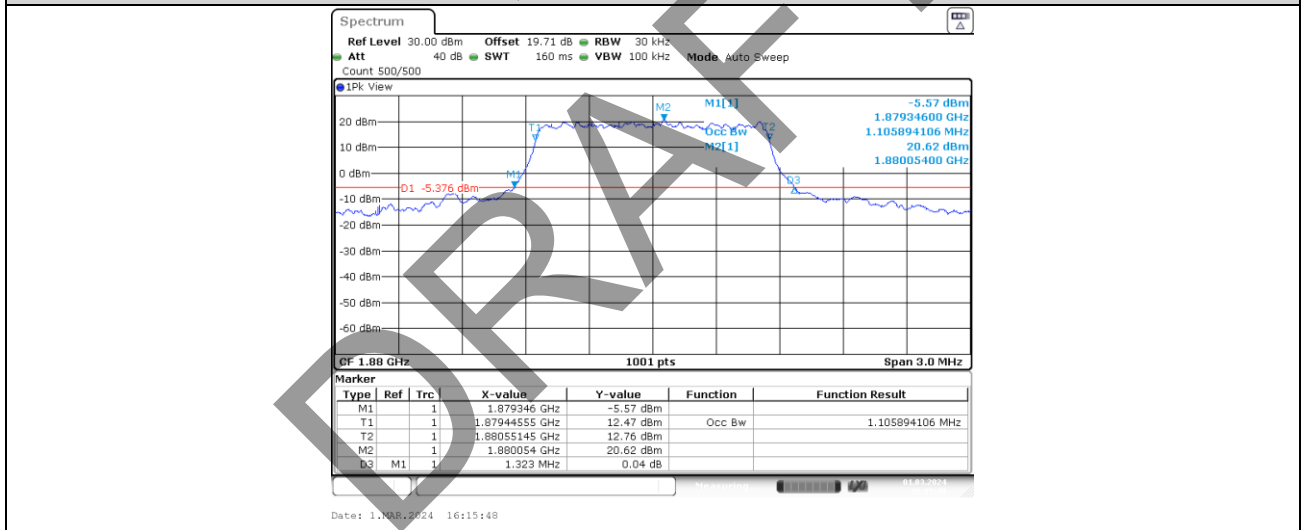

Band2-1.4MHz-QPSK-18900-6-0-Low-1.106-1.323-PASS



BUREAU VERITAS

Test Report No.: W7L-P23120015R102

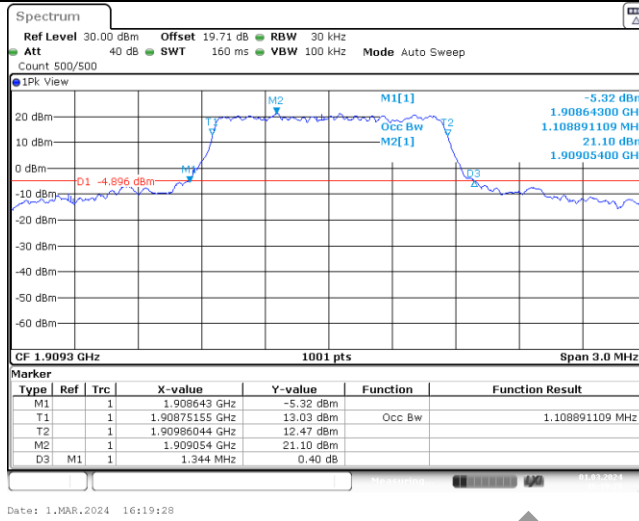

Band2-1.4MHz-QPSK-19193-6-0-High-1.109-1.344-PASS



Band2-1.4MHz-16QAM-18607-6-0-Low-1.106-1.353-PASS

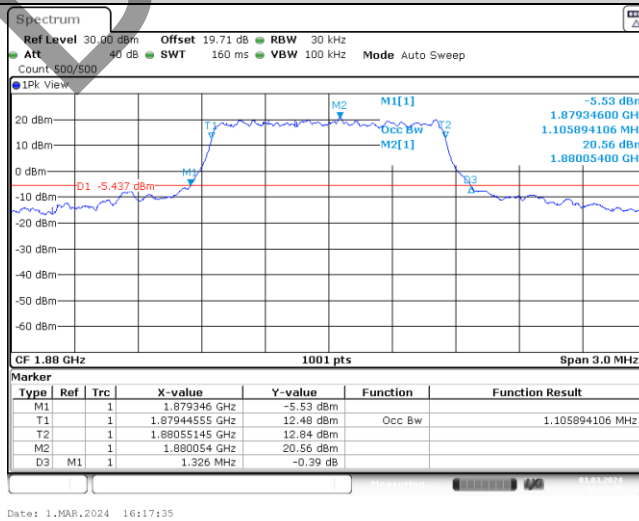

Band2-1.4MHz-16QAM-18900-6-0-Low-1.106-1.326-PASS

BV 7Layers Communications Technology (Shenzhen) Co., Ltd

Room B37, Warehouse A5, No.3 Chiwan 4th Road, Zhaoshang Street, Nanshan District Shenzhen, Guangdong, People's Republic of China

Tel: +86 755 8869 6566 Fax: +86 755 8869 6577

Email: customerservice.sw@bureauveritas.com



BUREAU VERITAS

Test Report No.: W7L-P23120015R102

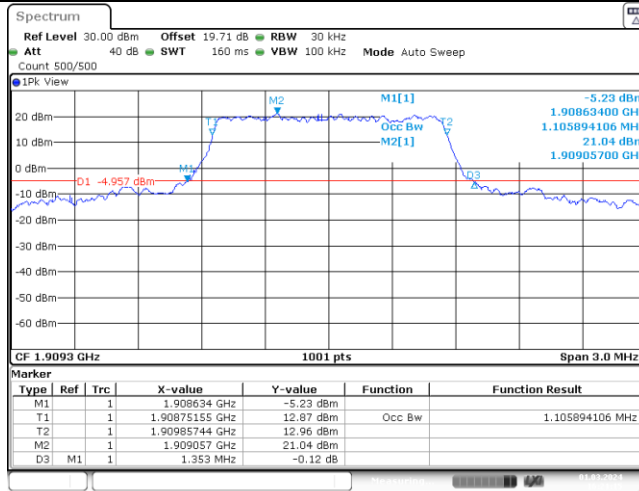

Date: 1.MAR.2024 16:21:15

Band2-1.4MHz-16QAM-19193-6-0-High-1.106-1.353-PASS

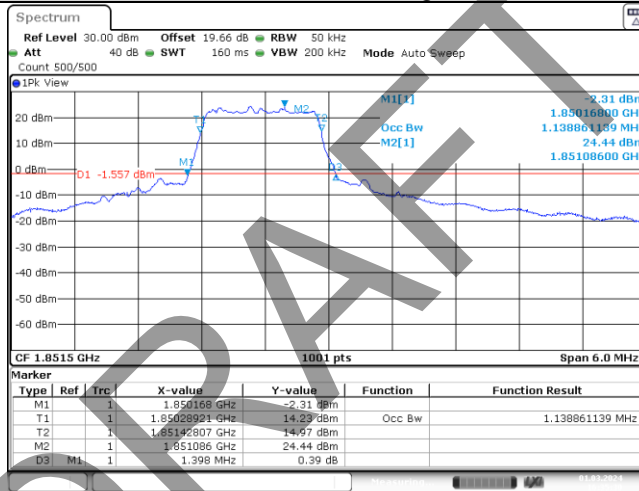

Date: 1.MAR.2024 16:35:30

Band2-3MHz-QPSK-18615-6-0-Low-1.139-1.398-PASS

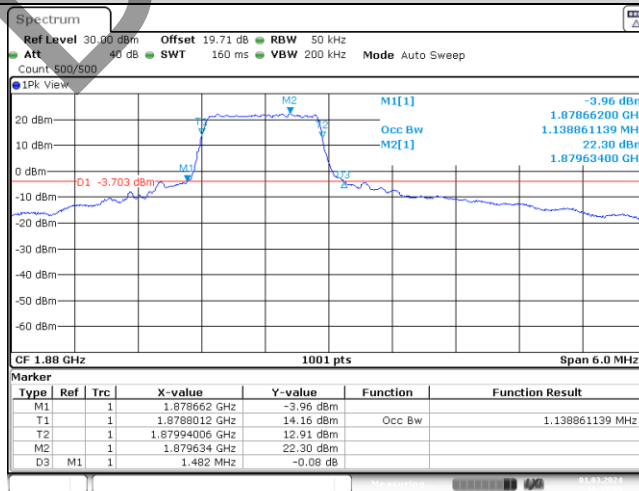

Date: 1.MAR.2024 16:39:06

Band2-3MHz-QPSK-18900-6-0-Low-1.139-1.482-PASS

BV 7Layers Communications Technology (Shenzhen) Co., Ltd

Room B37, Warehouse A5, No.3 Chiwan 4th Road, Zhaoshang Street, Nanshan District Shenzhen, Guangdong, People's Republic of China

Tel: +86 755 8869 6566 Fax: +86 755 8869 6577

Email: customerservice.sw@bureauveritas.com



BUREAU VERITAS

Test Report No.: W7L-P23120015R102

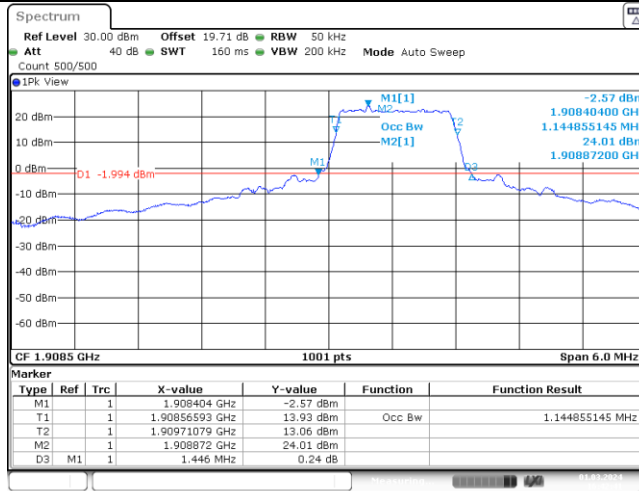

Date: 1.MAR.2024 16:42:41

Band2-3MHz-QPSK-19185-6-0-High-1.145-1.446-PASS

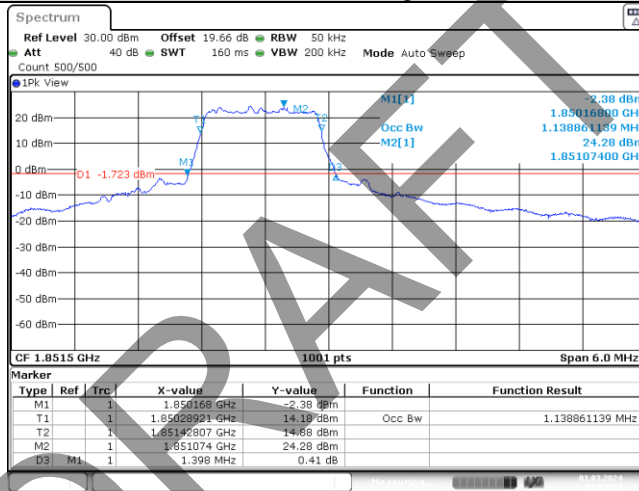

Date: 1.MAR.2024 16:37:17

Band2-3MHz-16QAM-18615-6-0-Low-1.139-1.398-PASS

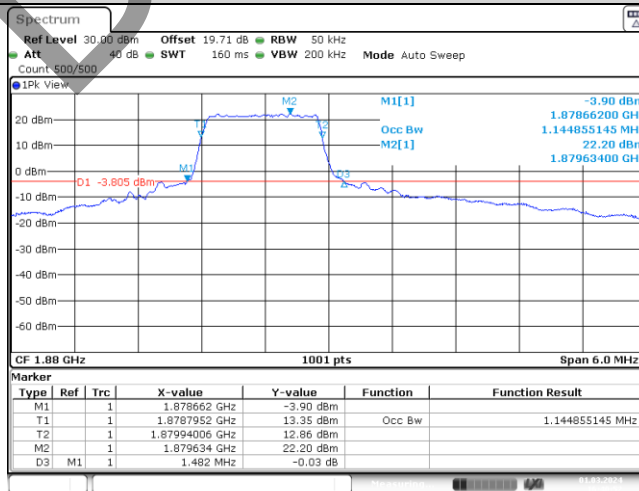

Date: 1.MAR.2024 16:40:53

Band2-3MHz-16QAM-18900-6-0-Low-1.145-1.482-PASS

BV 7Layers Communications Technology (Shenzhen) Co., Ltd

Room B37, Warehouse A5, No.3 Chiwan 4th Road, Zhaoshang Street, Nanshan District Shenzhen, Guangdong, People's Republic of China

Tel: +86 755 8869 6566 Fax: +86 755 8869 6577

Email: customerservice.sw@bureauveritas.com



BUREAU VERITAS

Test Report No.: W7L-P23120015R102

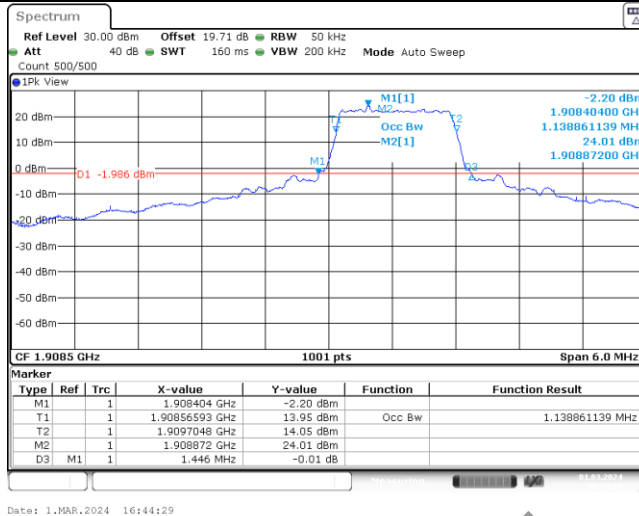

Band2-3MHz-16QAM-19185-6-0-High-1.139-1.446-PASS

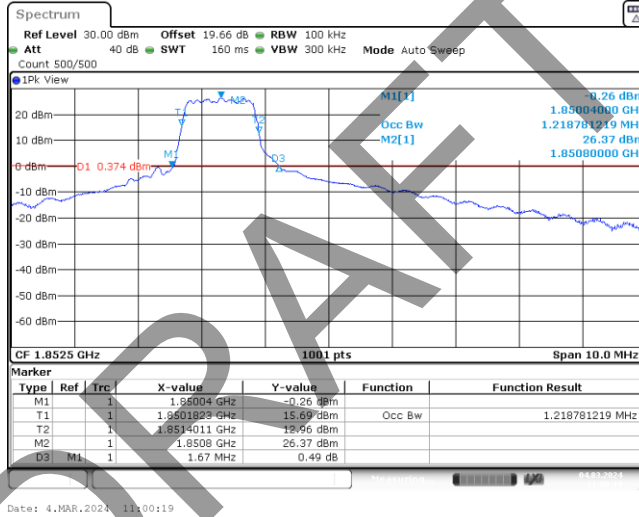

Band2-5MHz-QPSK-18625-6-0-Low-1.219-1.670-PASS

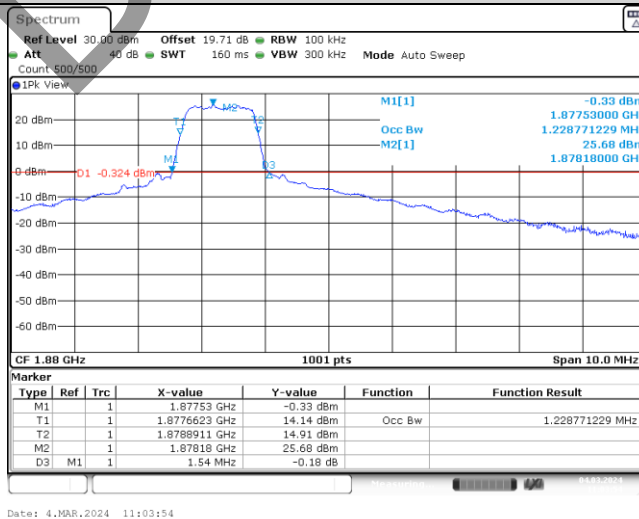

Band2-5MHz-QPSK-18900-6-0-Low-1.229-1.540-PASS

BV 7Layers Communications Technology (Shenzhen) Co., Ltd

Room B37, Warehouse A5, No.3 Chiwan 4th Road, Zhaoshang Street, Nanshan District Shenzhen, Guangdong, People's Republic of China

Tel: +86 755 8869 6566 Fax: +86 755 8869 6577

Email: customerservice.sw@bureauveritas.com



BUREAU VERITAS

Test Report No.: W7L-P23120015R102

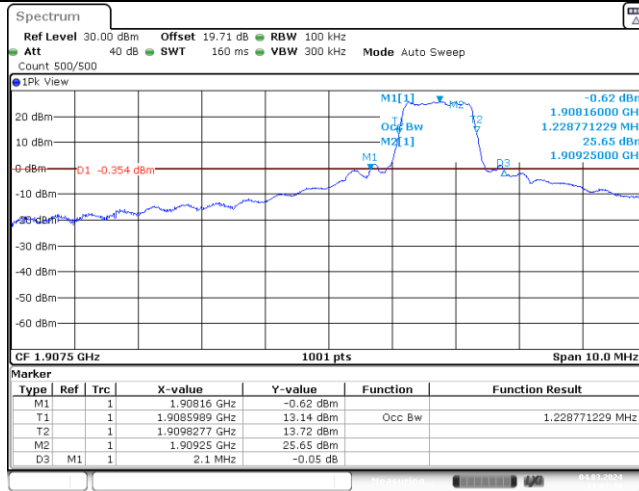

Band2-5MHz-QPSK-19175-6-0-High-1.229-2.100-PASS

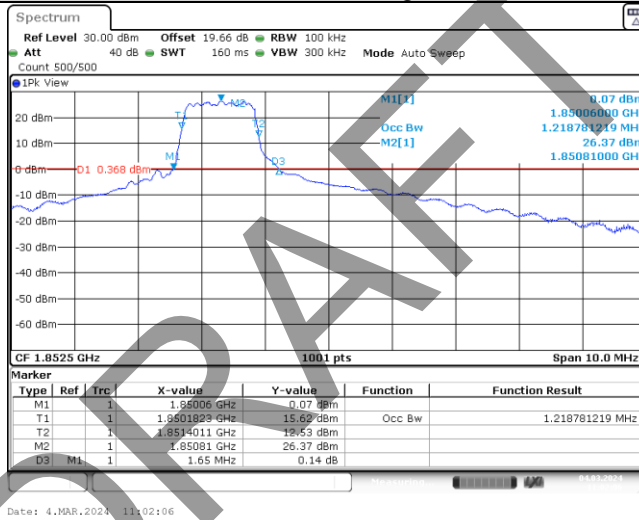

Band2-5MHz-16QAM-18625-6-0-Low-1.219-1.650-PASS

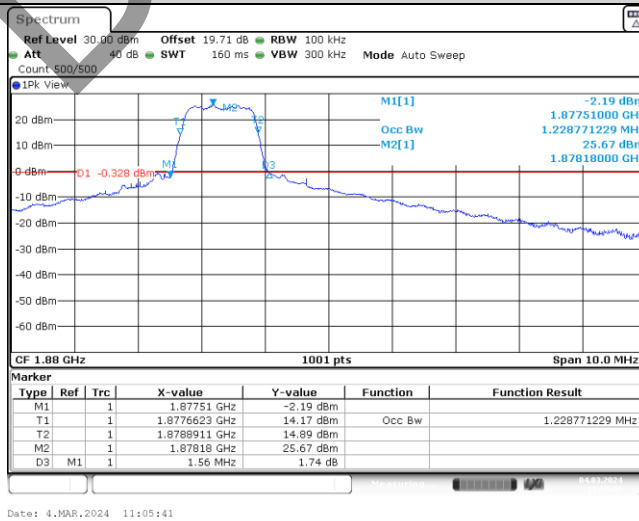

Band2-5MHz-16QAM-18900-6-0-Low-1.229-1.560-PASS

BV 7Layers Communications Technology (Shenzhen) Co., Ltd

Room B37, Warehouse A5, No.3 Chiwan 4th Road, Zhaoshang Street, Nanshan District Shenzhen, Guangdong, People's Republic of China

Tel: +86 755 8869 6566 Fax: +86 755 8869 6577

Email: customerservice.sw@bureauveritas.com



BUREAU VERITAS

Test Report No.: W7L-P23120015R102

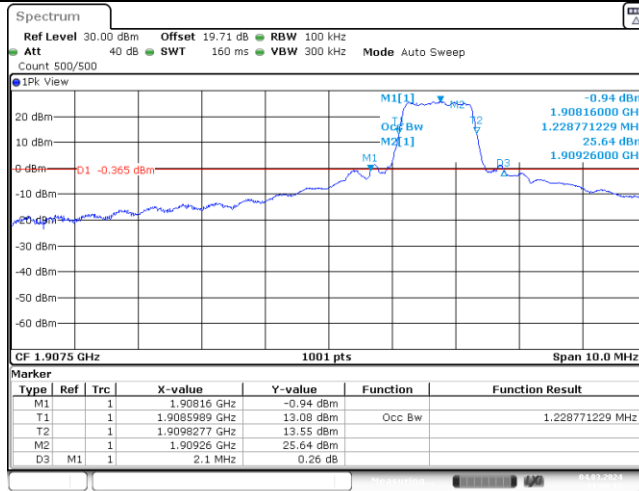

Date: 4.MAR.2024 11:09:17

Band2-5MHz-16QAM-19175-6-0-High-1.229-2.100-PASS

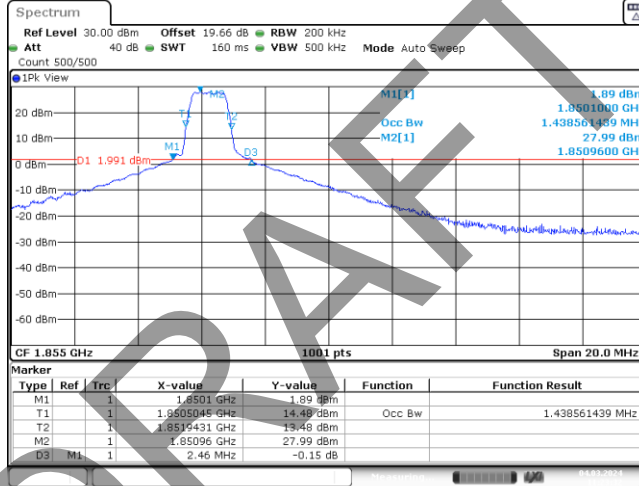

Date: 4.MAR.2024 11:23:32

Band2-10MHz-QPSK-18650-6-0-Low-1.439-2.460-PASS

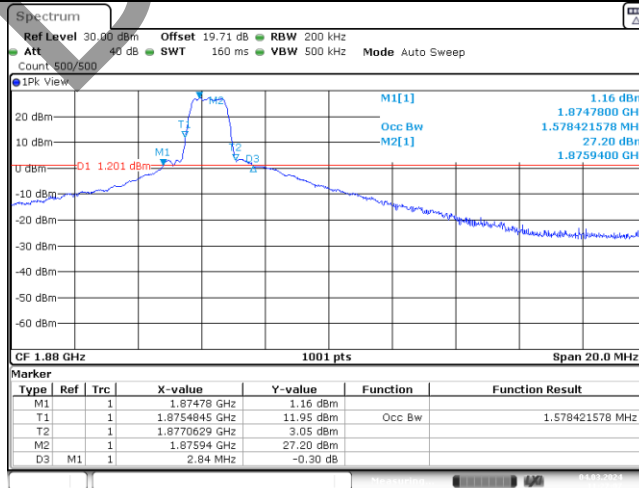

Date: 4.MAR.2024 11:27:07

Band2-10MHz-QPSK-18900-6-0-Low-1.578-2.840-PASS

BV 7Layers Communications Technology (Shenzhen) Co., Ltd

Room B37, Warehouse A5, No.3 Chiwan 4th Road, Zhaoshang Street, Nanshan District Shenzhen, Guangdong, People's Republic of China

Tel: +86 755 8869 6566 Fax: +86 755 8869 6577

Email: customerservice.sw@bureauveritas.com



BUREAU VERITAS

Test Report No.: W7L-P23120015R102

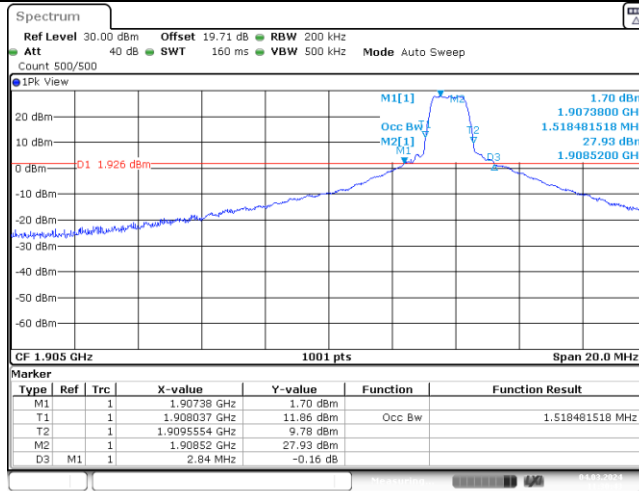

Date: 4.MAR.2024 11:30:43

Band2-10MHz-QPSK-19150-6-0-High-1.518-2.840-PASS

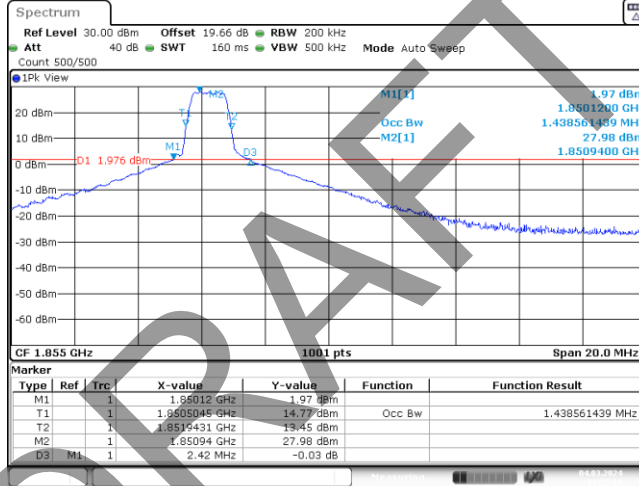

Date: 4.MAR.2024 11:25:19

Band2-10MHz-16QAM-18650-6-0-Low-1.439-2.420-PASS

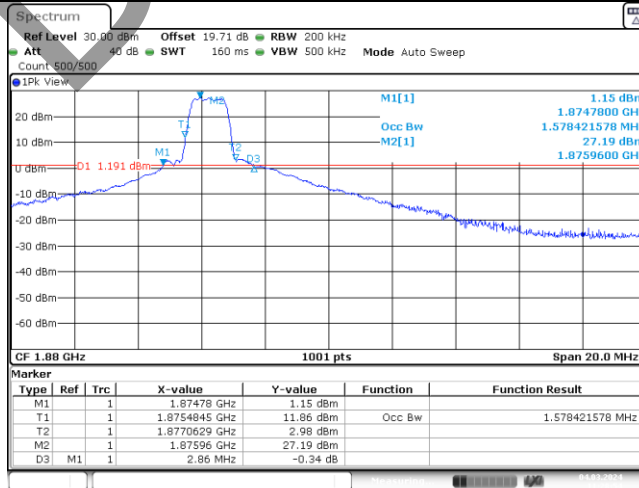

Date: 4.MAR.2024 11:28:54

Band2-10MHz-16QAM-18900-6-0-Low-1.578-2.860-PASS

BV 7Layers Communications Technology (Shenzhen) Co., Ltd

Room B37, Warehouse A5, No.3 Chiwan 4th Road, Zhaoshang Street, Nanshan District Shenzhen, Guangdong, People's Republic of China

Tel: +86 755 8869 6566 Fax: +86 755 8869 6577

Email: customerservice.sw@bureauveritas.com



BUREAU VERITAS

Test Report No.: W7L-P23120015R102

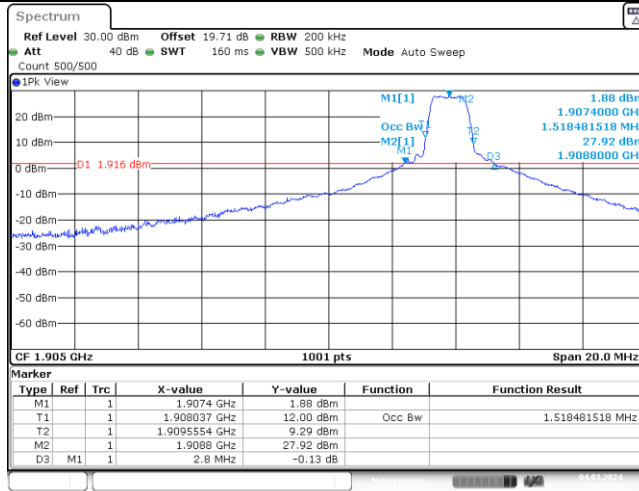

Band2-10MHz-16QAM-19150-6-0-High-1.518-2.800-PASS

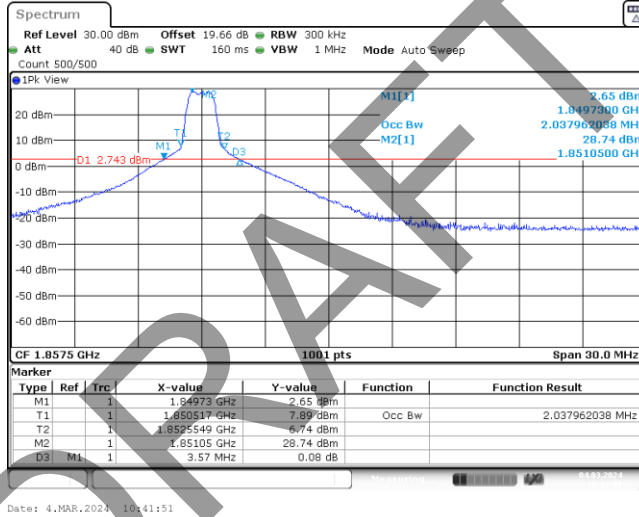

Band2-15MHz-QPSK-18675-6-0-Low-2.038-3.570-PASS

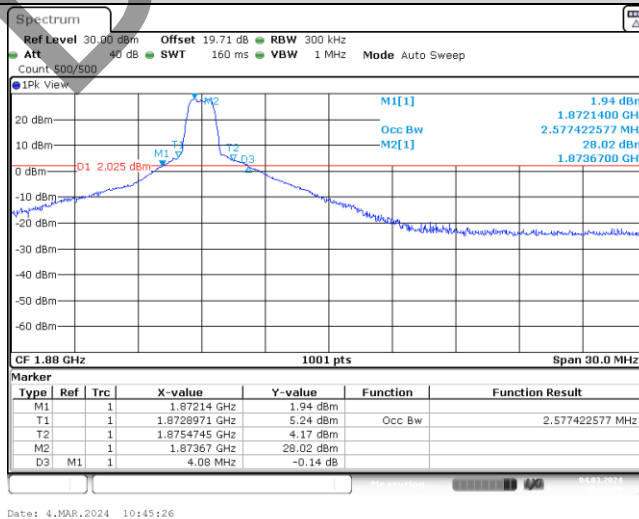

Band2-15MHz-QPSK-18900-6-0-Low-2.577-4.080-PASS

BV 7Layers Communications Technology (Shenzhen) Co., Ltd

Room B37, Warehouse A5, No.3 Chiwan 4th Road, Zhaoshang Street, Nanshan District Shenzhen, Guangdong, People's Republic of China

Tel: +86 755 8869 6566 Fax: +86 755 8869 6577

Email: customerservice.sw@bureauveritas.com



BUREAU VERITAS

Test Report No.: W7L-P23120015R102

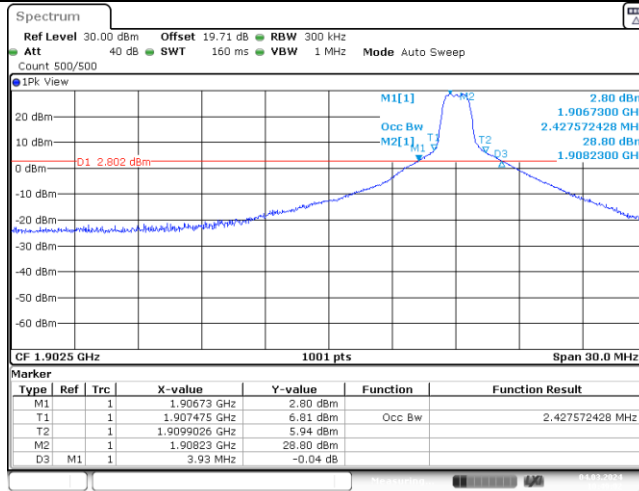

Band2-15MHz-QPSK-19125-6-0-High-2.428-3.930-PASS

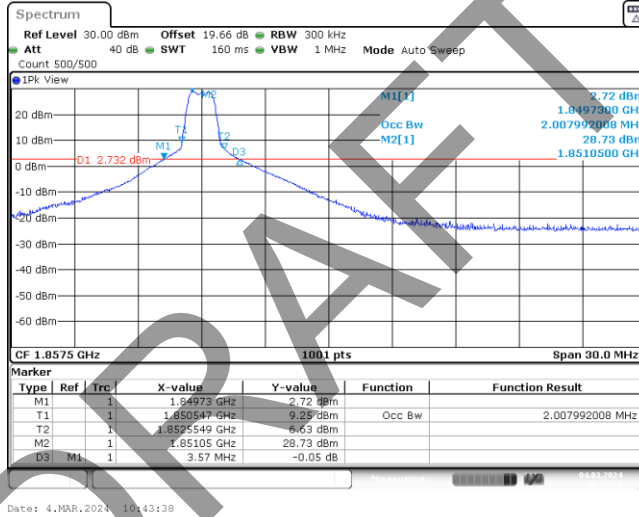

Band2-15MHz-16QAM-18675-6-0-Low-2.008-3.570-PASS

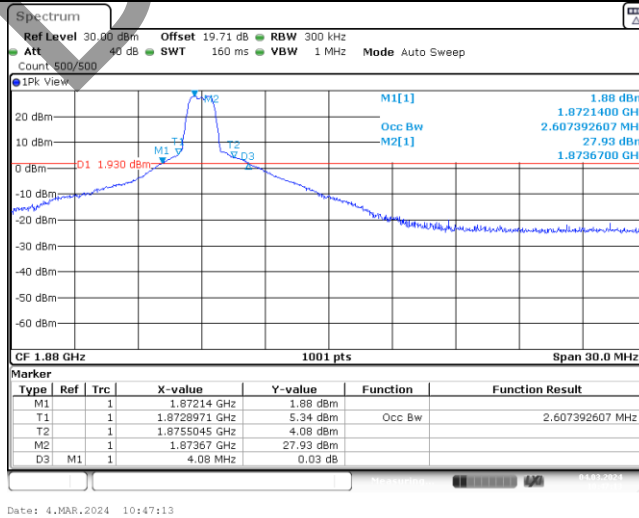

Band2-15MHz-16QAM-18900-6-0-Low-2.607-4.080-PASS

BV 7Layers Communications Technology (Shenzhen) Co., Ltd

Room B37, Warehouse A5, No.3 Chiwan 4th Road, Zhaoshang Street, Nanshan District Shenzhen, Guangdong, People's Republic of China

Tel: +86 755 8869 6566 Fax: +86 755 8869 6577

Email: customerservice.sw@bureauveritas.com



BUREAU VERITAS

Test Report No.: W7L-P23120015R102

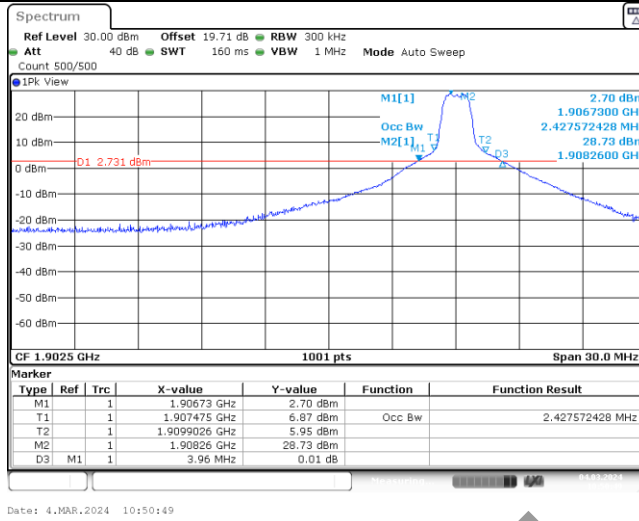

Band2-15MHz-16QAM-19125-6-0-High-2.428-3.960-PASS

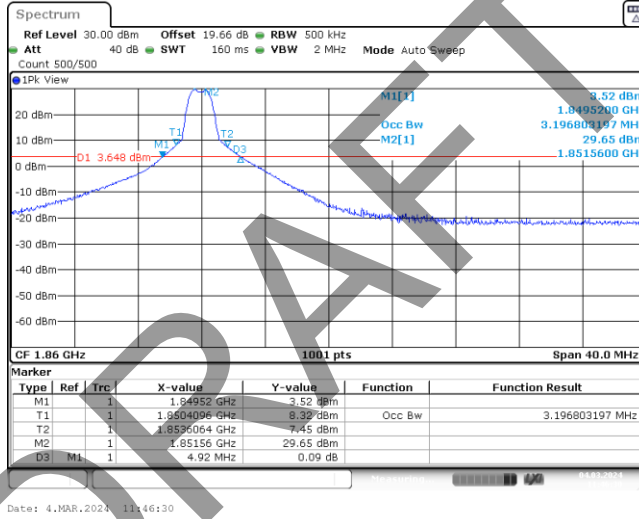

Band2-20MHz-QPSK-18700-6-0-Low-3.197-4.920-PASS

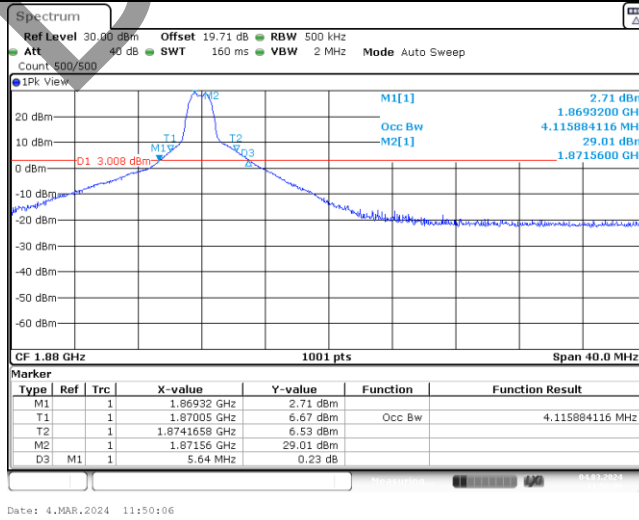

Band2-20MHz-QPSK-18900-6-0-Low-4.116-5.640-PASS

BV 7Layers Communications Technology (Shenzhen) Co., Ltd

Room B37, Warehouse A5, No.3 Chiwan 4th Road, Zhaoshang Street, Nanshan District Shenzhen, Guangdong, People's Republic of China

Tel: +86 755 8869 6566 Fax: +86 755 8869 6577

Email: customerservice.sw@bureauveritas.com



BUREAU VERITAS

Test Report No.: W7L-P23120015R102

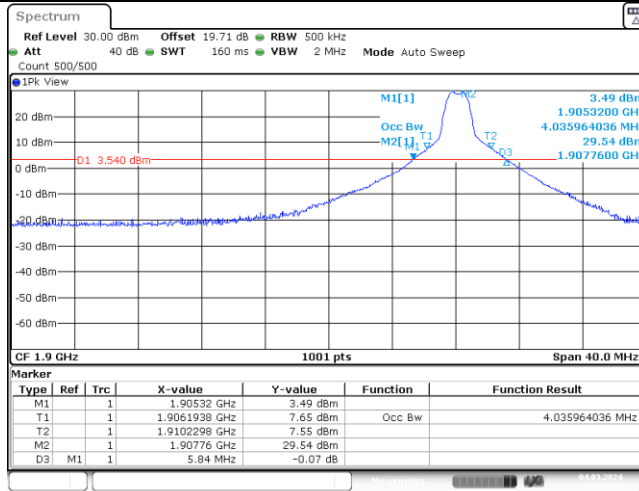

Date: 4.MAR.2024 11:53:42

Band2-20MHz-QPSK-19100-6-0-High-4.036-5.840-PASS

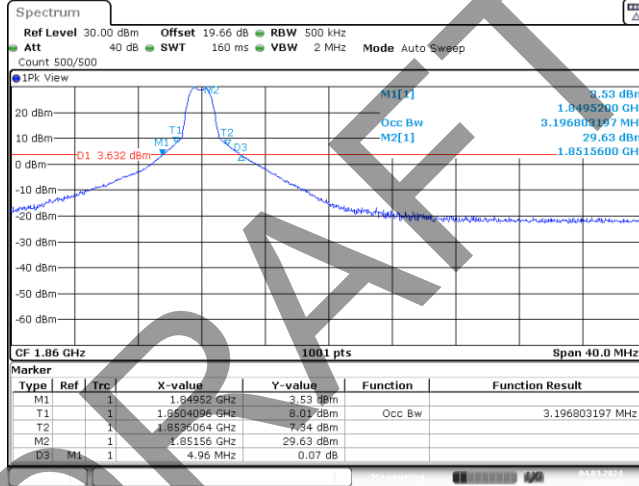

Date: 4.MAR.2024 11:48:17

Band2-20MHz-16QAM-18700-6-0-Low-3.197-4.960-PASS

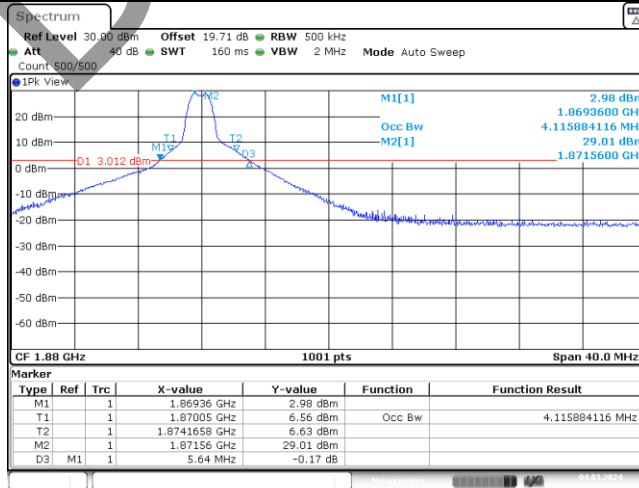

Date: 4.MAR.2024 11:51:53

Band2-20MHz-16QAM-18900-6-0-Low-4.116-5.640-PASS

BV 7Layers Communications Technology (Shenzhen) Co., Ltd

Room B37, Warehouse A5, No.3 Chiwan 4th Road, Zhaoshang Street, Nanshan District Shenzhen, Guangdong, People's Republic of China

Tel: +86 755 8869 6566 Fax: +86 755 8869 6577

Email: customerservice.sw@bureauveritas.com



BUREAU VERITAS

Test Report No.: W7L-P23120015R102

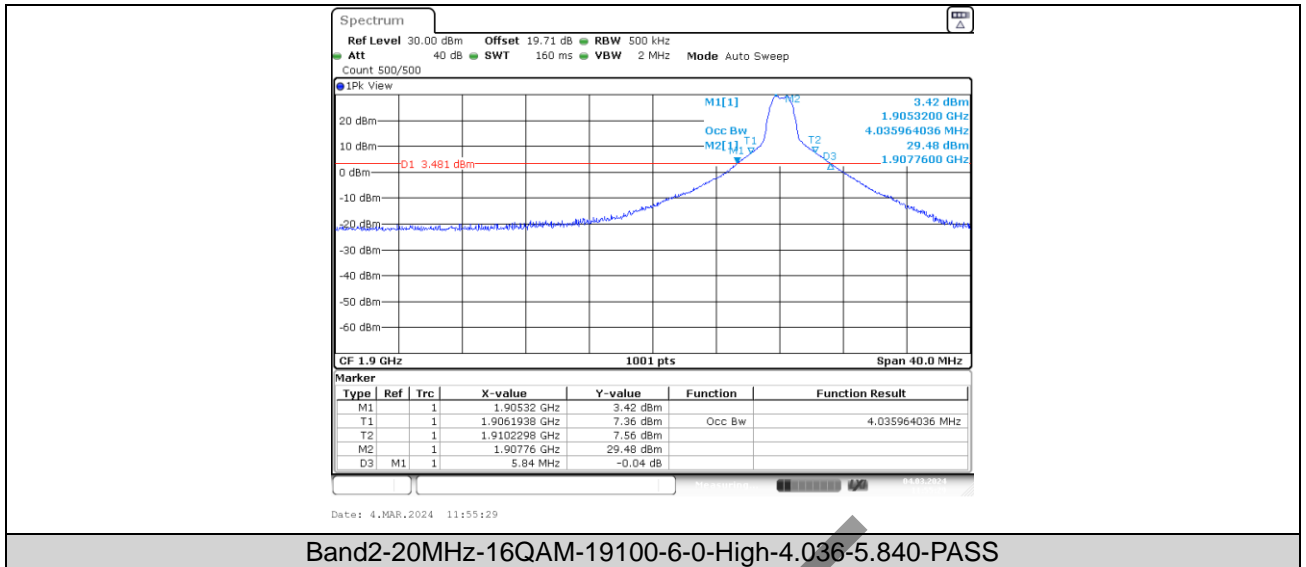

DRAFT



BAND 25 TEST RESULT

Band	Bandwidth	Modulation	Channel	RB Size	RB Start	NB Index	Occupied Bandwidth (MHz)	26dB Bandwidth (MHz)	Verdict
Band25	1.4MHz	26047	QPSK	6	0	Low	1.097	1.311	PASS
Band25	1.4MHz	26365	QPSK	6	0	Low	1.097	1.308	PASS
Band25	1.4MHz	26683	QPSK	6	0	High	1.097	1.311	PASS
Band25	1.4MHz	26047	16QAM	6	0	Low	1.097	1.320	PASS
Band25	1.4MHz	26365	16QAM	6	0	Low	1.097	1.308	PASS
Band25	1.4MHz	26683	16QAM	6	0	High	1.097	1.311	PASS
Band25	3MHz	26055	QPSK	6	0	Low	1.139	1.446	PASS
Band25	3MHz	26365	QPSK	6	0	Low	1.139	1.422	PASS
Band25	3MHz	26675	QPSK	6	0	High	1.133	1.722	PASS
Band25	3MHz	26055	16QAM	6	0	Low	1.139	1.452	PASS
Band25	3MHz	26365	16QAM	6	0	Low	1.139	1.410	PASS
Band25	3MHz	26675	16QAM	6	0	High	1.133	1.956	PASS
Band25	5MHz	26065	QPSK	6	0	Low	1.229	1.510	PASS
Band25	5MHz	26365	QPSK	6	0	Low	1.229	2.130	PASS
Band25	5MHz	26665	QPSK	6	0	High	1.229	1.790	PASS
Band25	5MHz	26065	16QAM	6	0	Low	1.229	1.570	PASS
Band25	5MHz	26365	16QAM	6	0	Low	1.229	1.740	PASS
Band25	5MHz	26665	16QAM	6	0	High	1.229	2.020	PASS
Band25	10MHz	26090	QPSK	6	0	Low	1.439	2.280	PASS
Band25	10MHz	26365	QPSK	6	0	Low	1.878	3.080	PASS
Band25	10MHz	26640	QPSK	6	0	High	1.538	2.680	PASS
Band25	10MHz	26090	16QAM	6	0	Low	1.439	2.280	PASS
Band25	10MHz	26365	16QAM	6	0	Low	1.878	3.120	PASS
Band25	10MHz	26640	16QAM	6	0	High	1.538	2.680	PASS
Band25	15MHz	26115	QPSK	6	0	Low	1.918	3.390	PASS
Band25	15MHz	26365	QPSK	6	0	Low	2.817	4.440	PASS
Band25	15MHz	26615	QPSK	6	0	High	2.547	4.170	PASS
Band25	15MHz	26115	16QAM	6	0	Low	1.918	3.420	PASS
Band25	15MHz	26365	16QAM	6	0	Low	2.847	4.380	PASS
Band25	15MHz	26615	16QAM	6	0	High	2.547	4.050	PASS
Band25	20MHz	26140	QPSK	6	0	Low	2.997	4.760	PASS
Band25	20MHz	26365	QPSK	6	0	Low	4.436	5.920	PASS
Band25	20MHz	26590	QPSK	6	0	High	4.076	5.880	PASS
Band25	20MHz	26140	16QAM	6	0	Low	2.997	4.760	PASS
Band25	20MHz	26365	16QAM	6	0	Low	4.436	5.920	PASS
Band25	20MHz	26590	16QAM	6	0	High	4.076	5.880	PASS



BUREAU VERITAS

Test Report No.: W7L-P23120015R102

BAND 25 TEST GRAPHS

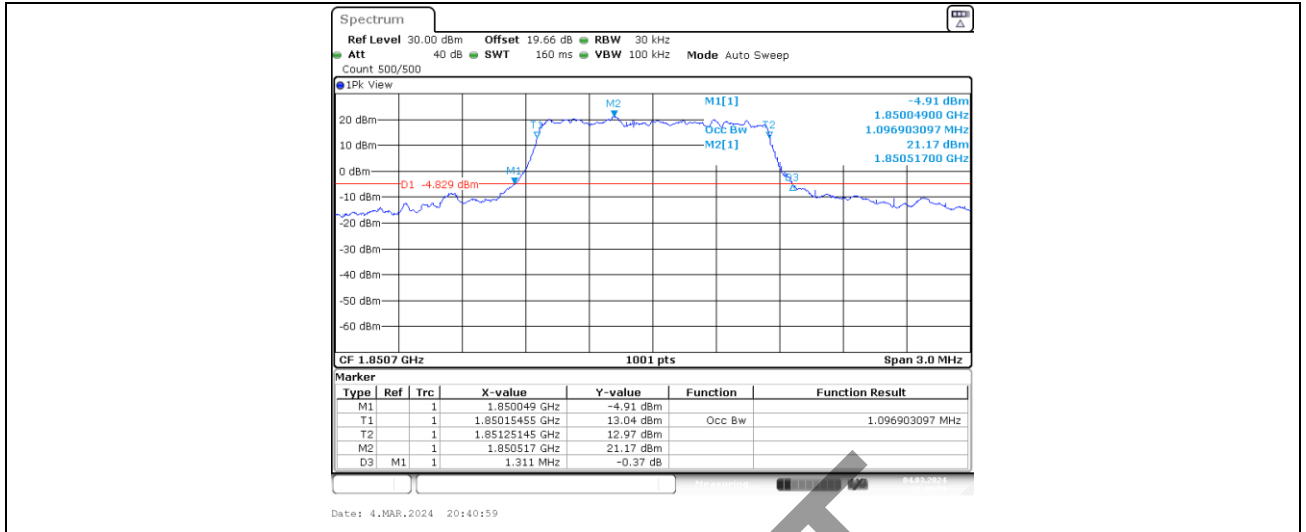

Band25-1.4MHz-QPSK-26047-6-0-Low-1.097-1.311-PASS



Band25-1.4MHz-QPSK-26365-6-0-Low-1.097-1.308-PASS

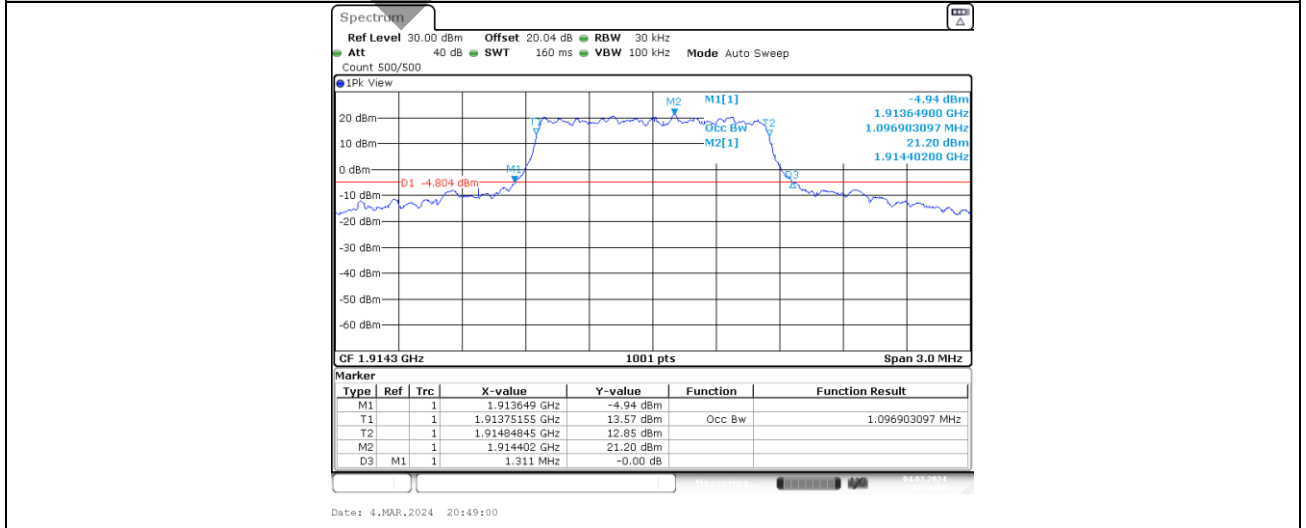

BV 7Layers Communications Technology (Shenzhen) Co., Ltd

Room B37, Warehouse A5, No.3 Chiwan 4th Road, Zhaoshang Street, Nanshan District Shenzhen, Guangdong, People's Republic of China

Tel: +86 755 8869 6566
Fax: +86 755 8869 6577

Email: customerservice.sw@bureauveritas.com



BUREAU VERITAS

Test Report No.: W7L-P23120015R102

Band25-1.4MHz-QPSK-26683-6-0-High-1.097-1.311-PASS

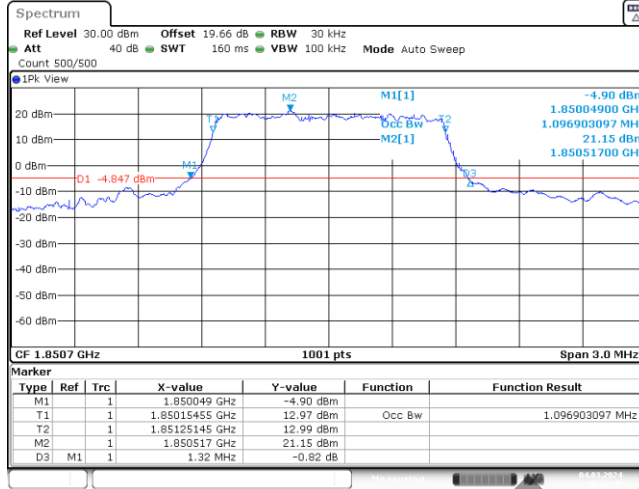

Date: 4.MAR.2024 20:42:46

Band25-1.4MHz-16QAM-26047-6-0-Low-1.097-1.320-PASS

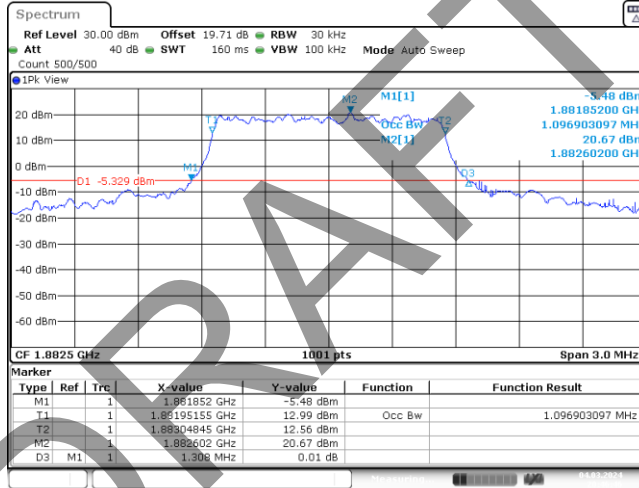

Date: 4.MAR.2024 20:46:46

Band25-1.4MHz-16QAM-26365-6-0-Low-1.097-1.308-PASS

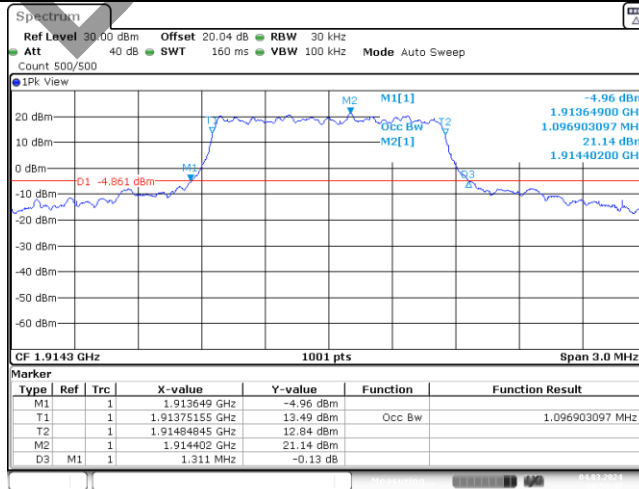

Date: 4.MAR.2024 20:50:47

Band25-1.4MHz-16QAM-26683-6-0-High-1.097-1.311-PASS

BV 7Layers Communications Technology (Shenzhen) Co., Ltd

Room B37, Warehouse A5, No.3 Chiwan 4th Road, Zhaoshang Street, Nanshan District Shenzhen, Guangdong, People's Republic of China

Tel: +86 755 8869 6566 Fax: +86 755 8869 6577

Email: customerservice.sw@bureauveritas.com



BUREAU VERITAS

Test Report No.: W7L-P23120015R102

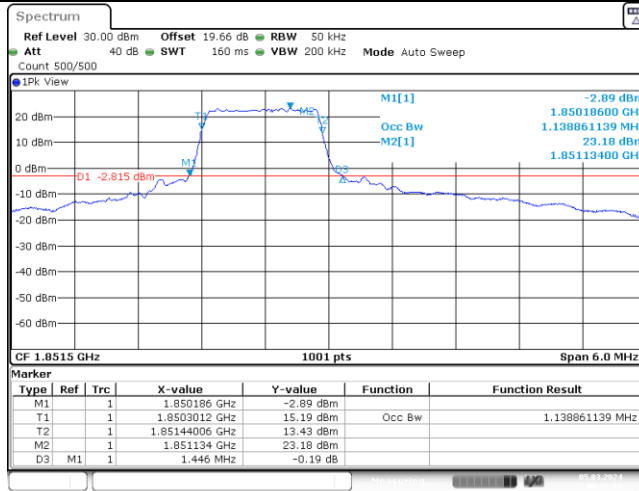

Date: 5.MAR.2024 09:07:18

Band25-3MHz-QPSK-26055-6-0-Low-1.139-1.446-PASS



Date: 5.MAR.2024 09:10:54

Band25-3MHz-QPSK-26365-6-0-Low-1.139-1.422-PASS

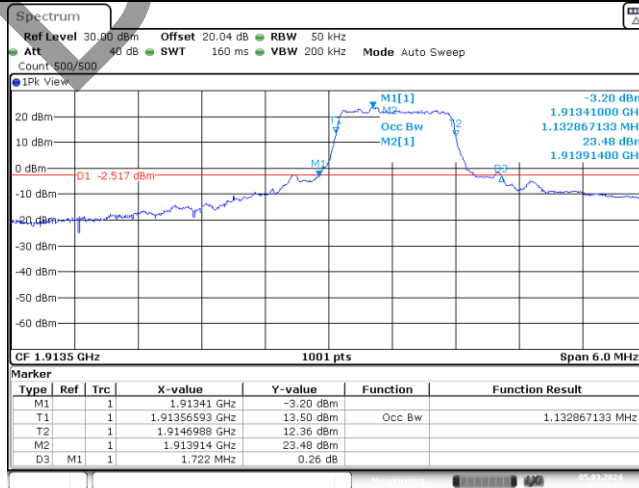

Date: 5.MAR.2024 09:14:30

Band25-3MHz-QPSK-26675-6-0-High-1.133-1.722-PASS

BV 7Layers Communications Technology (Shenzhen) Co., Ltd

Room B37, Warehouse A5, No.3 Chiwan 4th Road, Zhaoshang Street, Nanshan District Shenzhen, Guangdong, People's Republic of China

Tel: +86 755 8869 6566 Fax: +86 755 8869 6577

Email: customerservice.sw@bureauveritas.com



BUREAU VERITAS

Test Report No.: W7L-P23120015R102

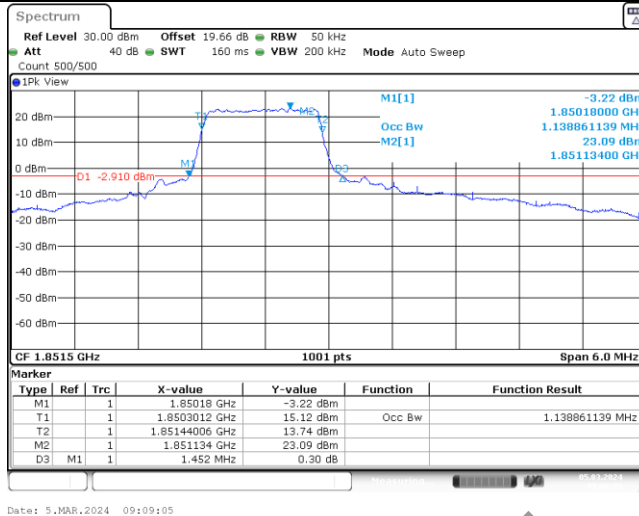

Band25-3MHz-16QAM-26055-6-0-Low-1.139-1.452-PASS

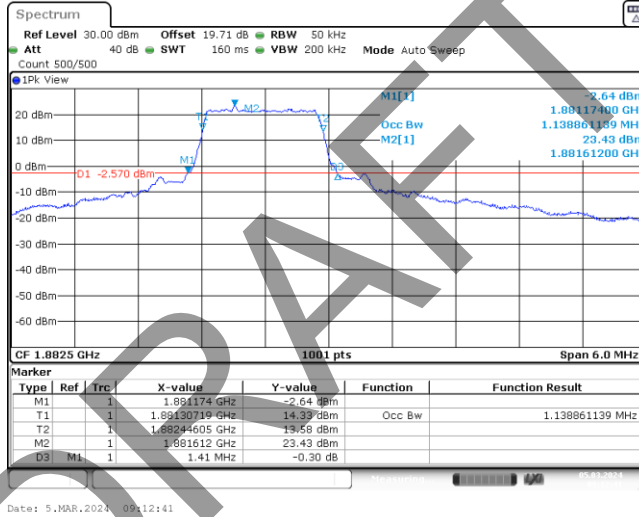

Band25-3MHz-16QAM-26365-6-0-Low-1.139-1.410-PASS

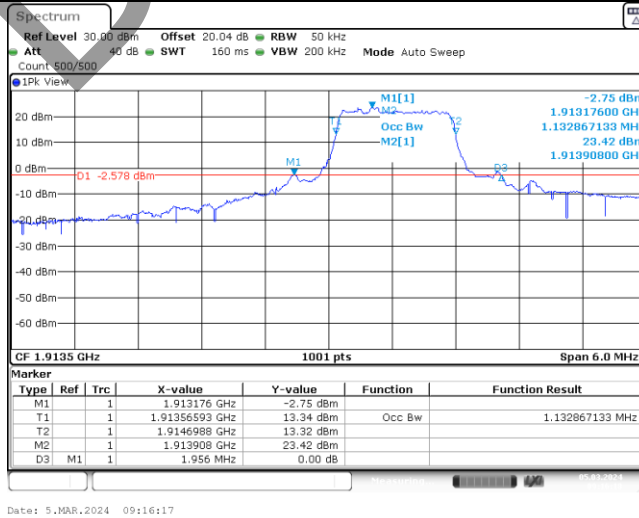

Band25-3MHz-16QAM-26675-6-0-High-1.133-1.956-PASS

BV 7Layers Communications Technology (Shenzhen) Co., Ltd

Room B37, Warehouse A5, No.3 Chiwan 4th Road, Zhaoshang Street, Nanshan District Shenzhen, Guangdong, People's Republic of China

Tel: +86 755 8869 6566
Fax: +86 755 8869 6577

Email: customerservice.sw@bureauveritas.com



BUREAU VERITAS

Test Report No.: W7L-P23120015R102

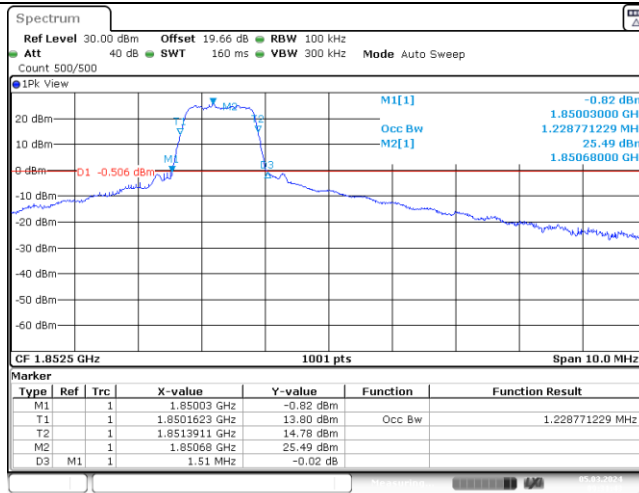

Date: 5.MAR.2024 09:31:43

Band25-5MHz-QPSK-26065-6-0-Low-1.229-1.510-PASS



Date: 5.MAR.2024 09:35:18

Band25-5MHz-QPSK-26365-6-0-Low-1.229-2.130-PASS

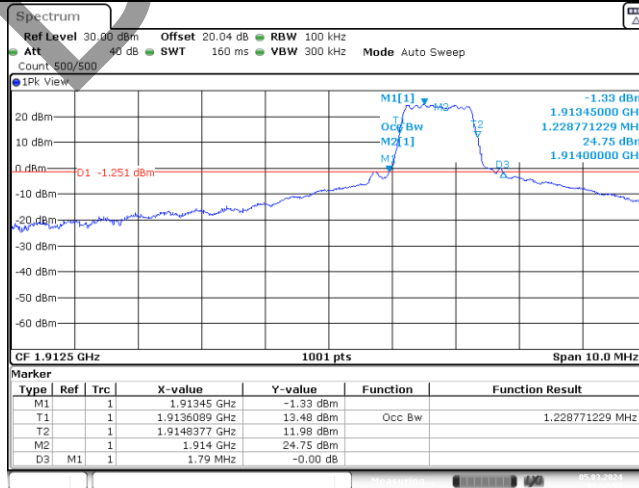

Date: 5.MAR.2024 09:57:55

Band25-5MHz-QPSK-26665-6-0-High-1.229-1.790-PASS

BV 7Layers Communications Technology (Shenzhen) Co., Ltd

Room B37, Warehouse A5, No.3 Chiwan 4th Road, Zhaoshang Street, Nanshan District Shenzhen, Guangdong, People's Republic of China

Tel: +86 755 8869 6566 Fax: +86 755 8869 6577

Email: customerservice.sw@bureauveritas.com



BUREAU VERITAS

Test Report No.: W7L-P23120015R102

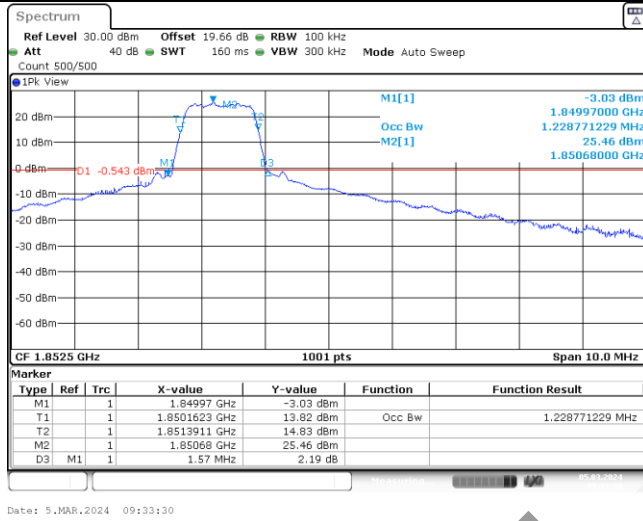

Band25-5MHz-16QAM-26065-6-0-Low-1.229-1.570-PASS



Band25-5MHz-16QAM-26365-6-0-Low-1.229-1.740-PASS

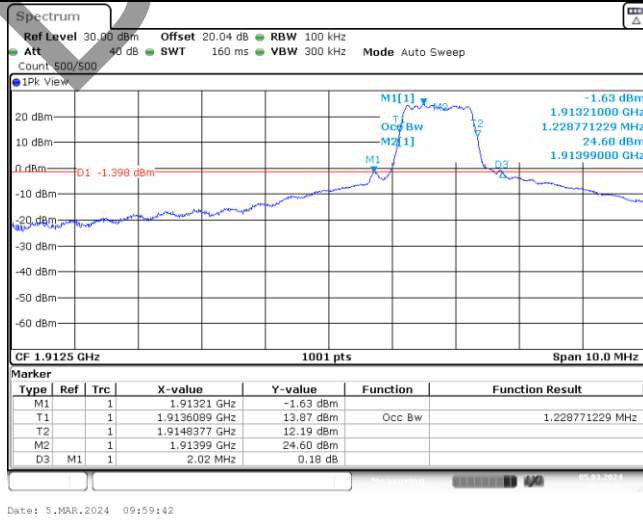

Band25-5MHz-16QAM-26665-6-0-High-1.229-2.020-PASS

BV 7Layers Communications Technology (Shenzhen) Co., Ltd

Room B37, Warehouse A5, No.3 Chiwan 4th Road, Zhaoshang Street, Nanshan District Shenzhen, Guangdong, People's Republic of China

Tel: +86 755 8869 6566 Fax: +86 755 8869 6577

Email: customerservice.sw@bureauveritas.com



BUREAU VERITAS

Test Report No.: W7L-P23120015R102

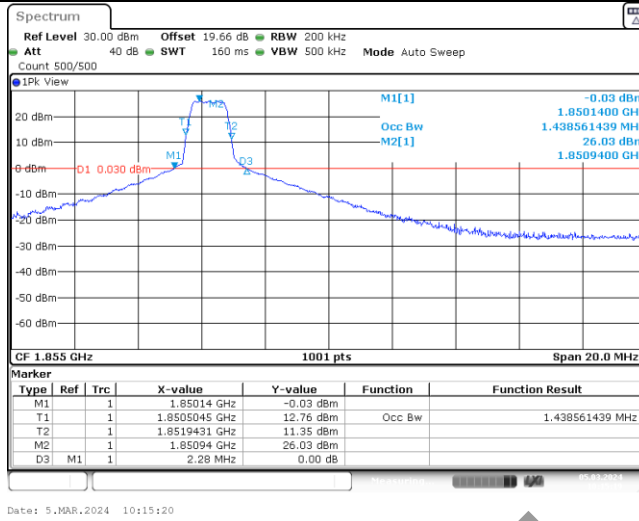

Band25-10MHz-QPSK-26090-6-0-Low-1.439-2.280-PASS

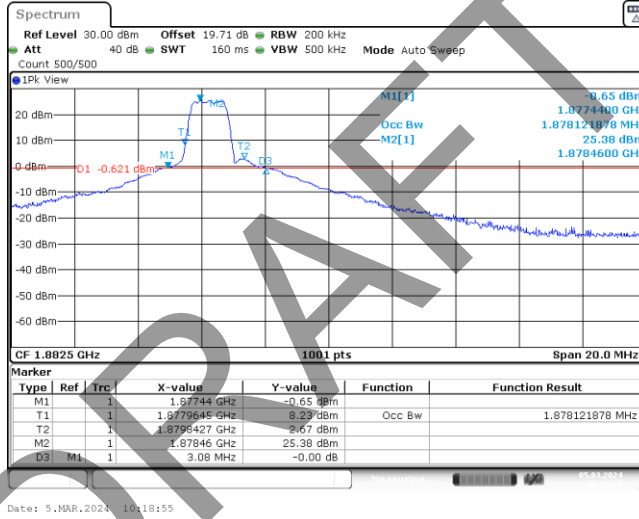

Band25-10MHz-QPSK-26365-6-0-Low-1.878-3.080-PASS

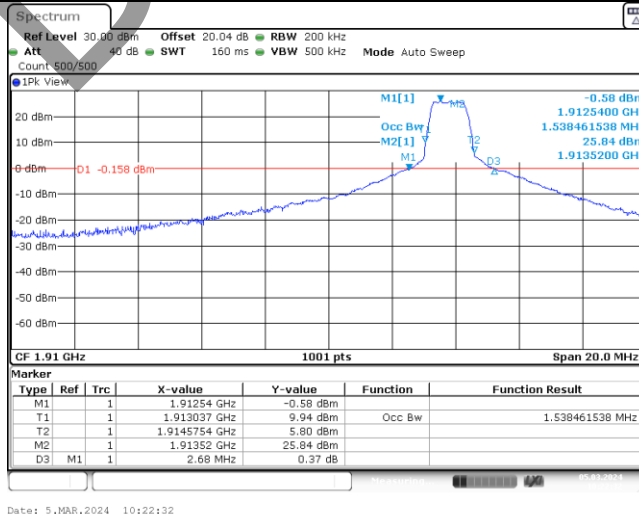

Band25-10MHz-QPSK-26640-6-0-High-1.538-2.680-PASS

BV 7Layers Communications Technology (Shenzhen) Co., Ltd

Room B37, Warehouse A5, No.3 Chiwan 4th Road, Zhaoshang Street, Nanshan District Shenzhen, Guangdong, People's Republic of China

Tel: +86 755 8869 6566 Fax: +86 755 8869 6577

Email: customerservice.sw@bureauveritas.com



BUREAU VERITAS

Test Report No.: W7L-P23120015R102

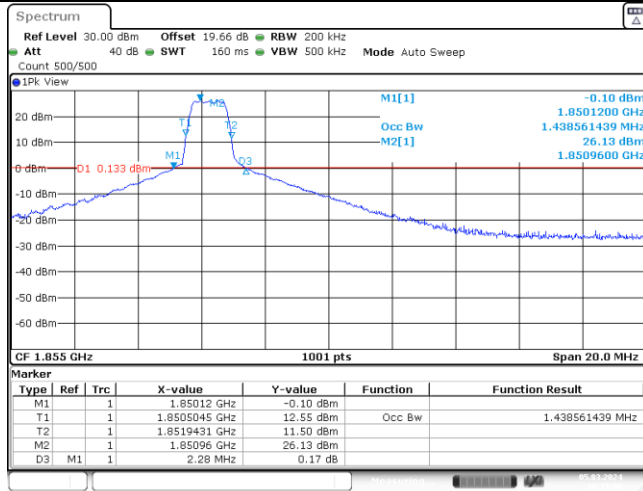

Date: 5.MAR.2024 10:17:07

Band25-10MHz-16QAM-26090-6-0-Low-1.439-2.280-PASS

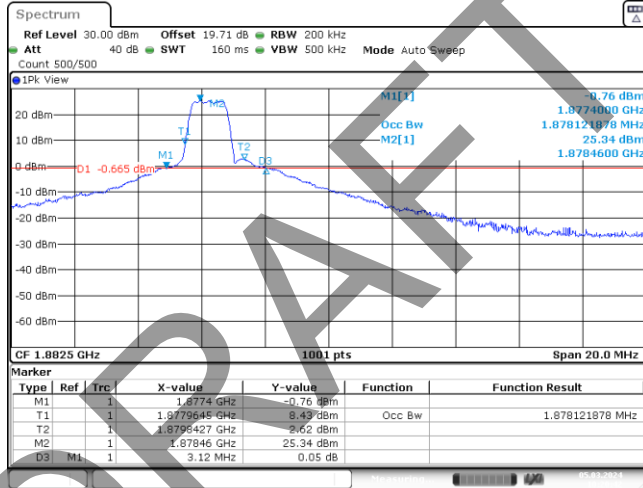

Date: 5.MAR.2024 10:20:42

Band25-10MHz-16QAM-26365-6-0-Low-1.878-3.120-PASS

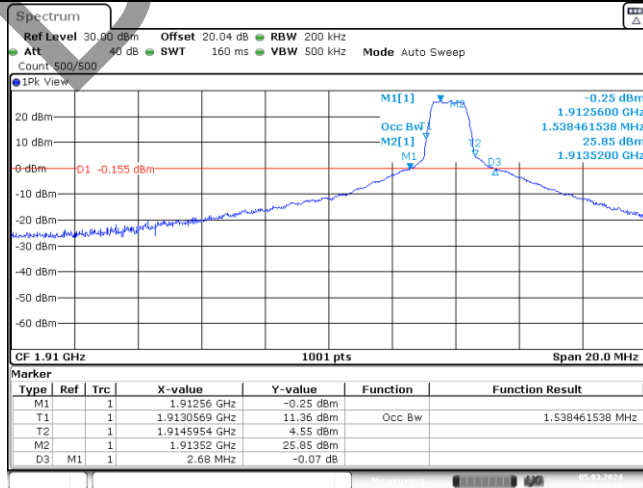

Date: 5.MAR.2024 10:24:19

Band25-10MHz-16QAM-26640-6-0-High-1.538-2.680-PASS

BV 7Layers Communications Technology (Shenzhen) Co., Ltd

Room B37, Warehouse A5, No.3 Chiwan 4th Road, Zhaoshang Street, Nanshan District Shenzhen, Guangdong, People's Republic of China

Tel: +86 755 8869 6566 Fax: +86 755 8869 6577

Email: customerservice.sw@bureauveritas.com



BUREAU VERITAS

Test Report No.: W7L-P23120015R102

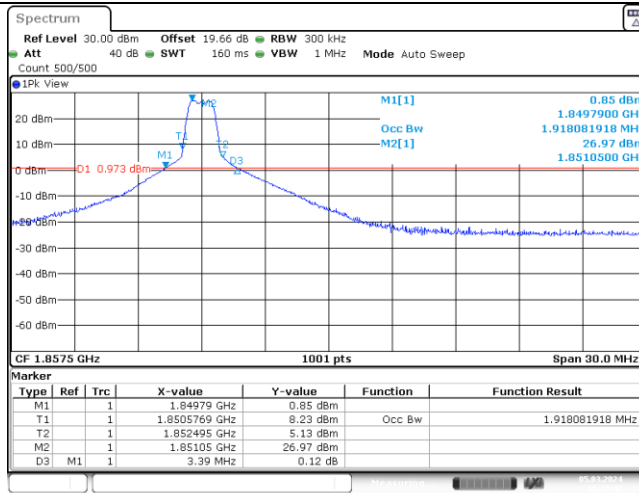

Date: 5.MAR.2024 10:39:42

Band25-15MHz-QPSK-26115-6-0-Low-1.918-3.390-PASS

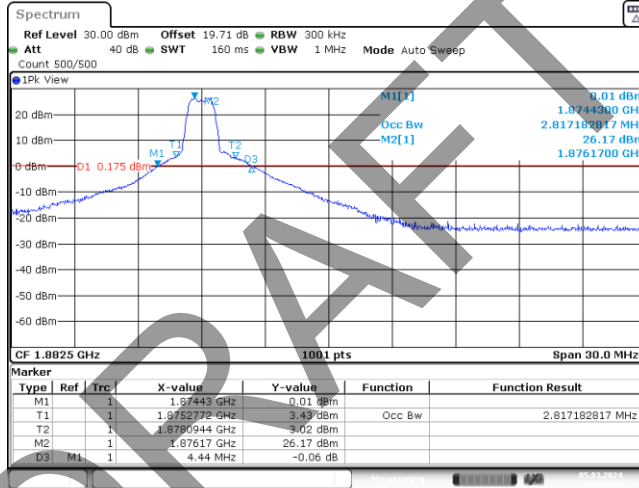

Date: 5.MAR.2024 10:43:18

Band25-15MHz-QPSK-26365-6-0-Low-2.817-4.440-PASS

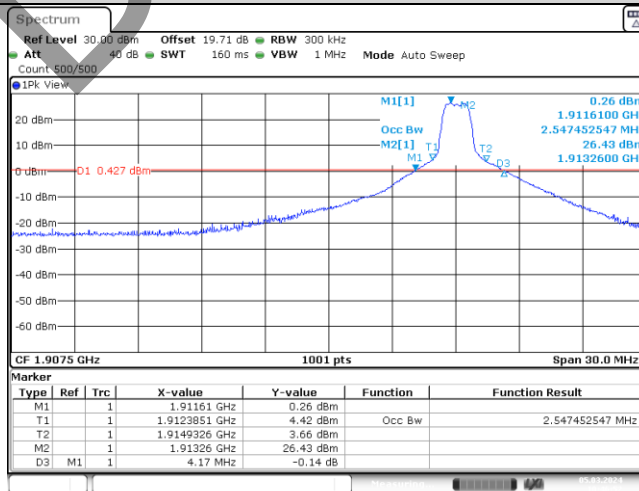

Date: 5.MAR.2024 10:46:53

Band25-15MHz-QPSK-26615-6-0-High-2.547-4.170-PASS

BV 7Layers Communications Technology (Shenzhen) Co., Ltd

Room B37, Warehouse A5, No.3 Chiwan 4th Road, Zhaoshang Street, Nanshan District Shenzhen, Guangdong, People's Republic of China

Tel: +86 755 8869 6566 Fax: +86 755 8869 6577

Email: customerservice.sw@bureauveritas.com



BUREAU VERITAS

Test Report No.: W7L-P23120015R102

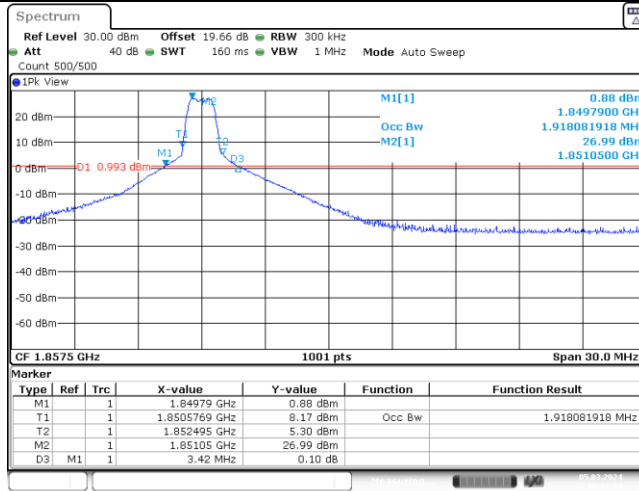

Date: 5.MAR.2024 10:41:29

Band25-15MHz-16QAM-26115-6-0-Low-1.918-3.420-PASS

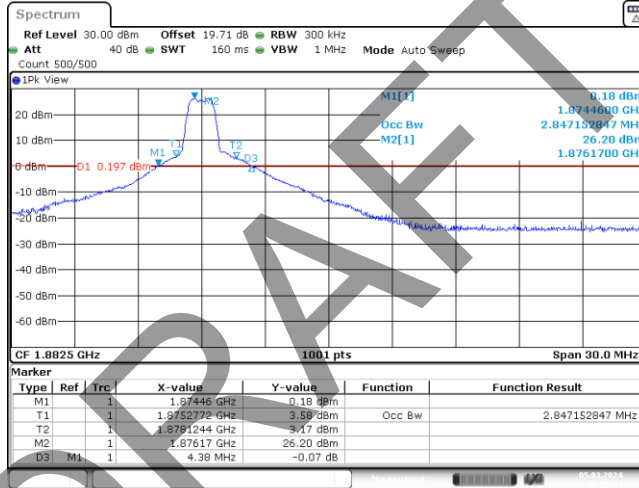

Date: 5.MAR.2024 10:45:05

Band25-15MHz-16QAM-26365-6-0-Low-2.847-4.380-PASS

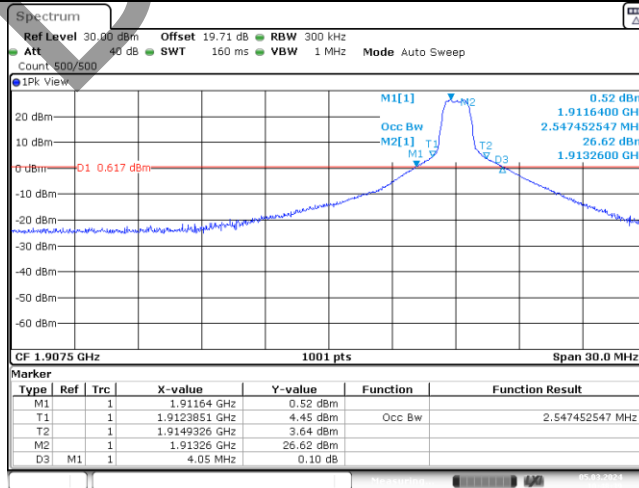

Date: 5.MAR.2024 10:48:40

Band25-15MHz-16QAM-26615-6-0-High-2.547-4.050-PASS

BV 7Layers Communications Technology (Shenzhen) Co., Ltd

Room B37, Warehouse A5, No.3 Chiwan 4th Road, Zhaoshang Street, Nanshan District Shenzhen, Guangdong, People's Republic of China

Tel: +86 755 8869 6566 Fax: +86 755 8869 6577

Email: customerservice.sw@bureauveritas.com



BUREAU VERITAS

Test Report No.: W7L-P23120015R102

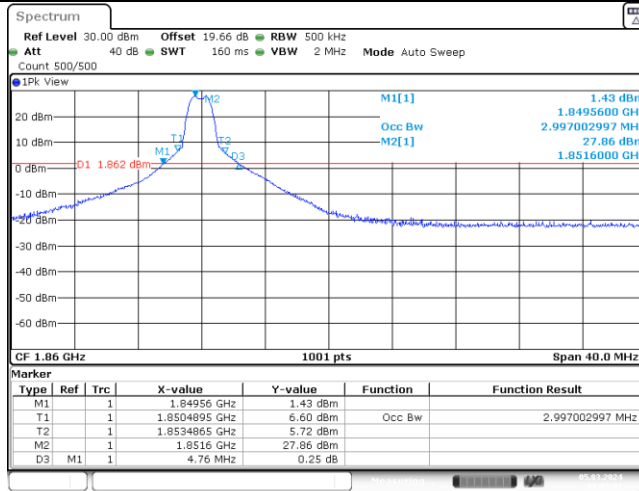

Band25-20MHz-QPSK-26140-6-0-Low-2.997-4.760-PASS

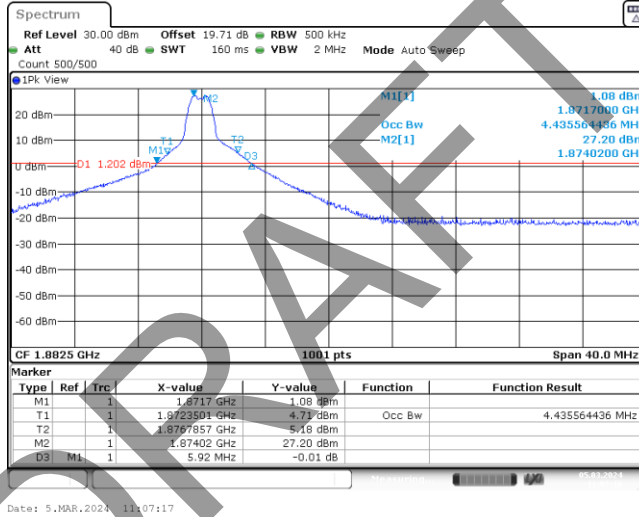

Band25-20MHz-QPSK-26365-6-0-Low-4.436-5.920-PASS

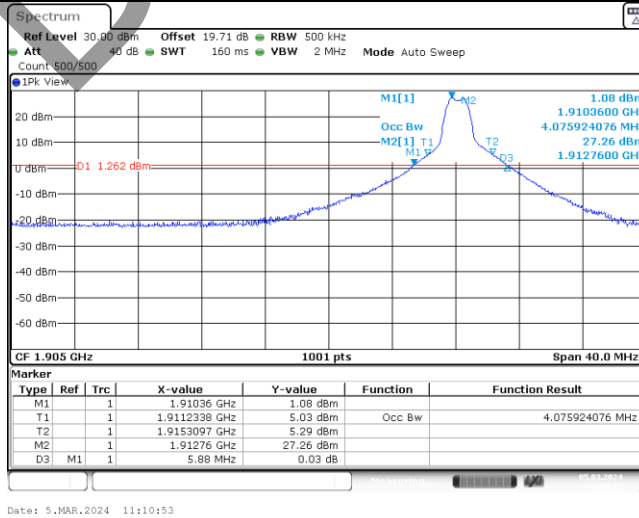

Band25-20MHz-QPSK-26590-6-0-High-4.076-5.880-PASS

BV 7Layers Communications Technology (Shenzhen) Co., Ltd

Room B37, Warehouse A5, No.3 Chiwan 4th Road, Zhaoshang Street, Nanshan District Shenzhen, Guangdong, People's Republic of China

Tel: +86 755 8869 6566 Fax: +86 755 8869 6577

Email: customerservice.sw@bureauveritas.com



BUREAU VERITAS

Test Report No.: W7L-P23120015R102

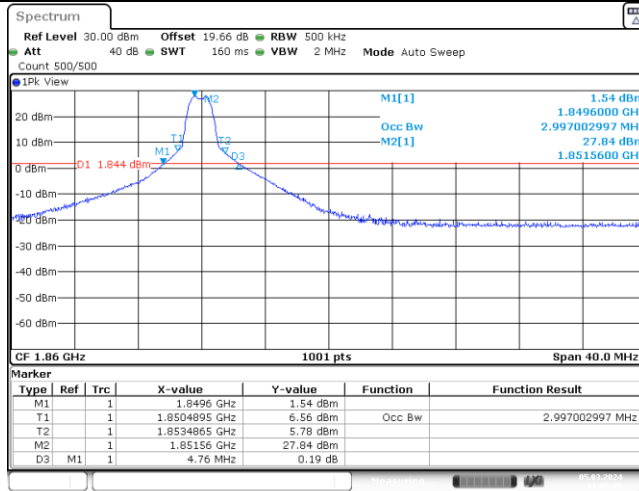

Date: 5.MAR.2024 11:05:28

Band25-20MHz-16QAM-26140-6-0-Low-2.997-4.760-PASS

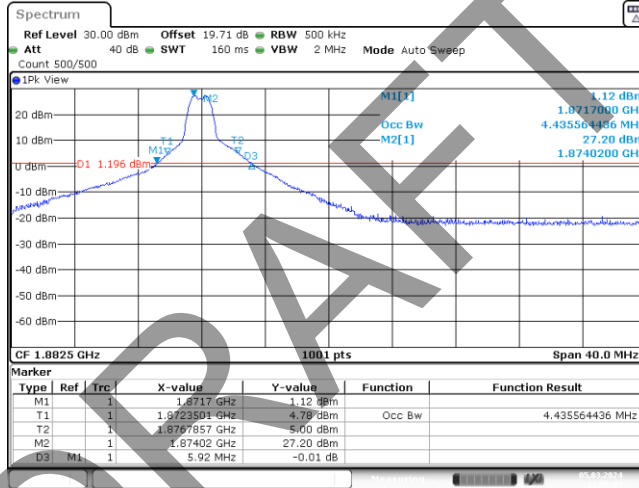

Date: 5.MAR.2024 11:09:04

Band25-20MHz-16QAM-26365-6-0-Low-4.436-5.920-PASS

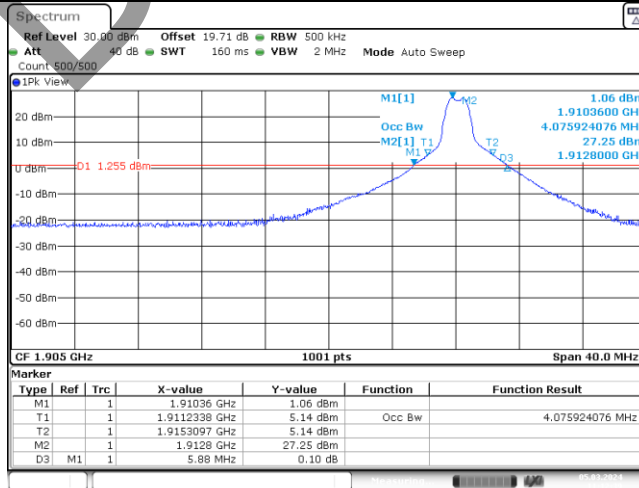

Date: 5.MAR.2024 11:12:39

Band25-20MHz-16QAM-26590-6-0-High-4.076-5.880-PASS

BV 7Layers Communications Technology (Shenzhen) Co., Ltd

Room B37, Warehouse A5, No.3 Chiwan 4th Road, Zhaoshang Street, Nanshan District Shenzhen, Guangdong, People's Republic of China

Tel: +86 755 8869 6566 Fax: +86 755 8869 6577

Email: customerservice.sw@bureauveritas.com



BUREAU
VERITAS

Test Report No.: W7L-P23120015R102

BAND EDGE FOR M1 GPRS 1900 TEST GRAPHS

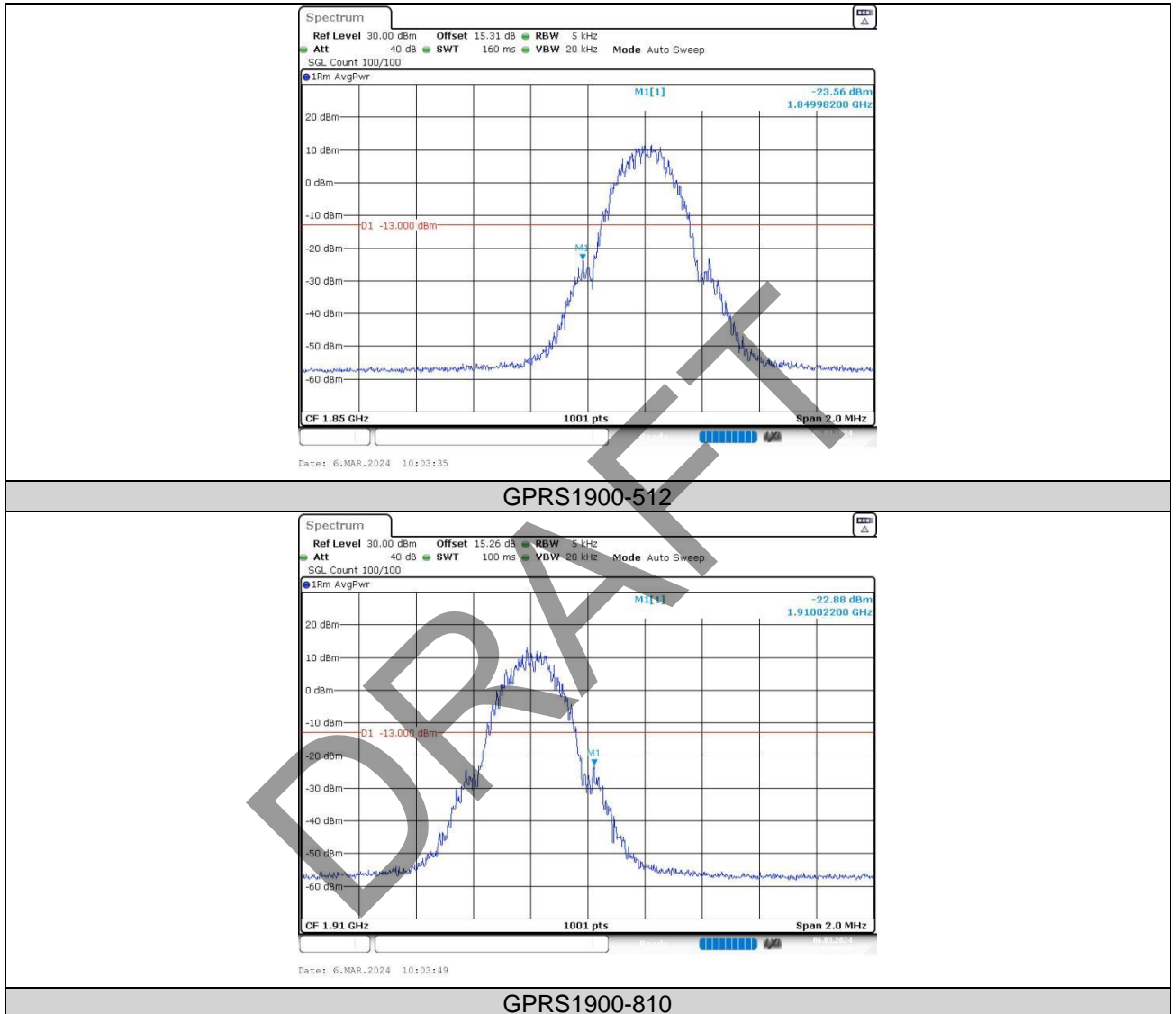



BUREAU
VERITAS

Test Report No.: W7L-P23120015R102

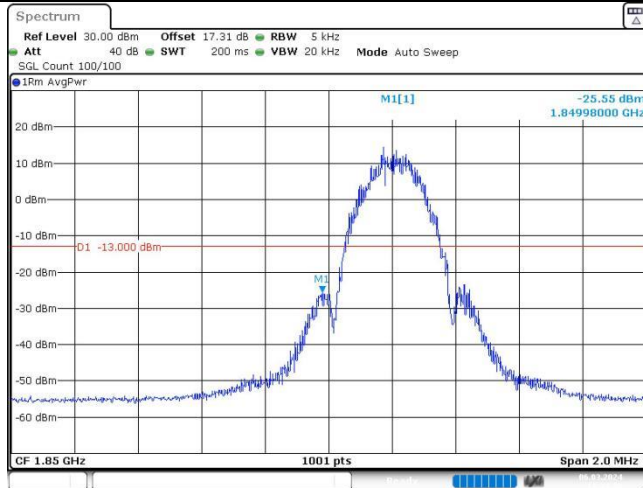

Date: 6.MAR.2024 10:34:00

EGPRS1900-512



Date: 6.MAR.2024 10:34:24

EGPRS1900-810



BUREAU VERITAS

Test Report No.: W7L-P23120015R102

BAND 2 TEST GRAPHS

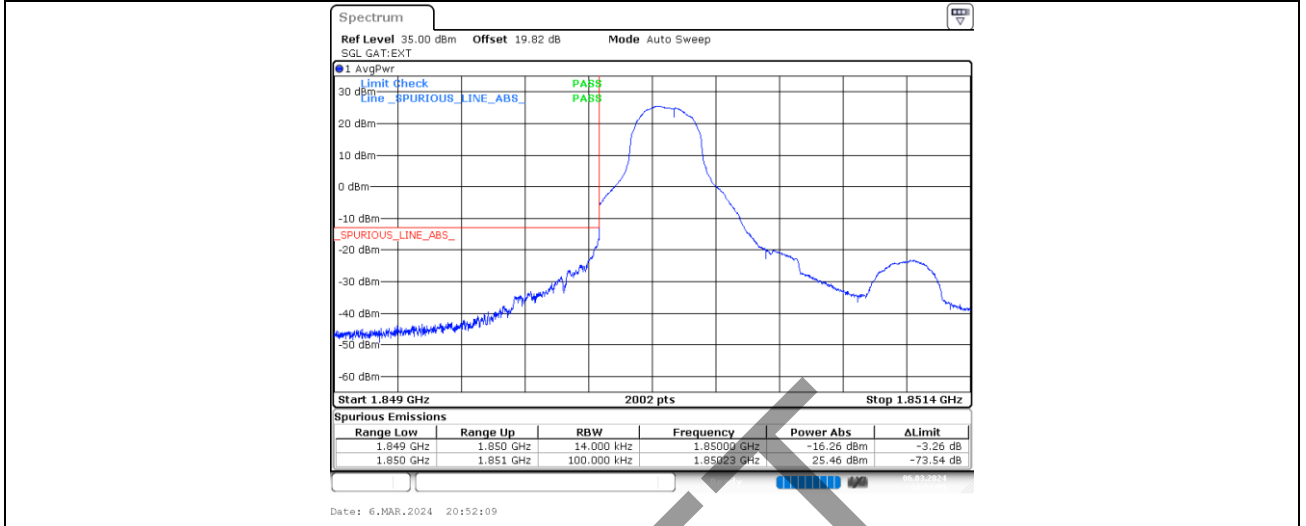

Band2-1.4MHz-QPSK-18607-1-0-Low-1850.00--16.26-3.26-PASS

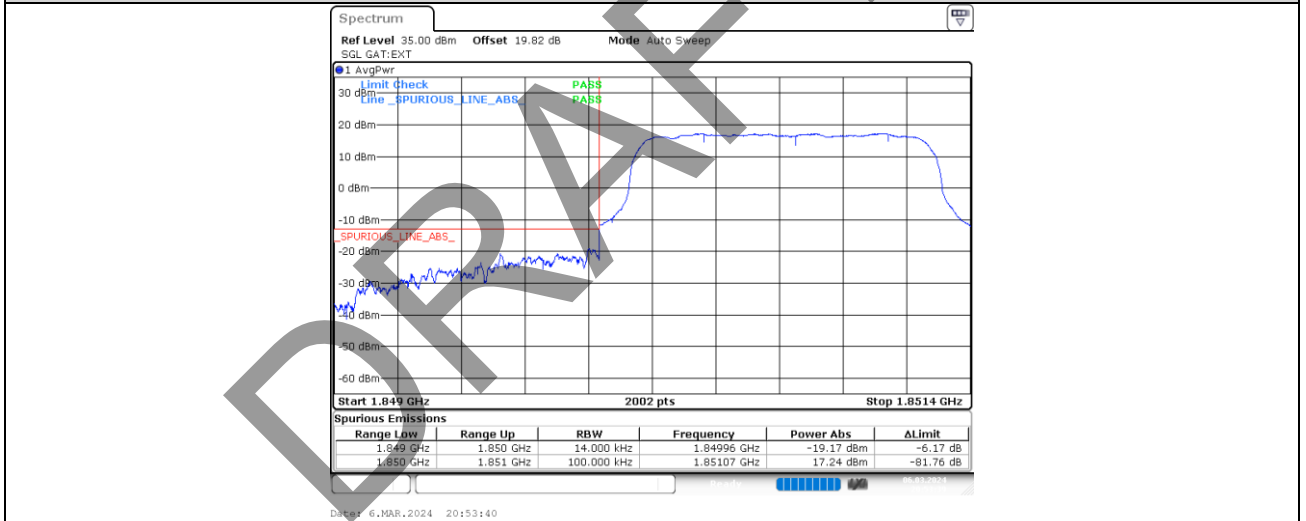

Band2-1.4MHz-QPSK-18607-6-0-Low-1849.96--19.17-6.17-PASS



BUREAU VERITAS

Test Report No.: W7L-P23120015R102

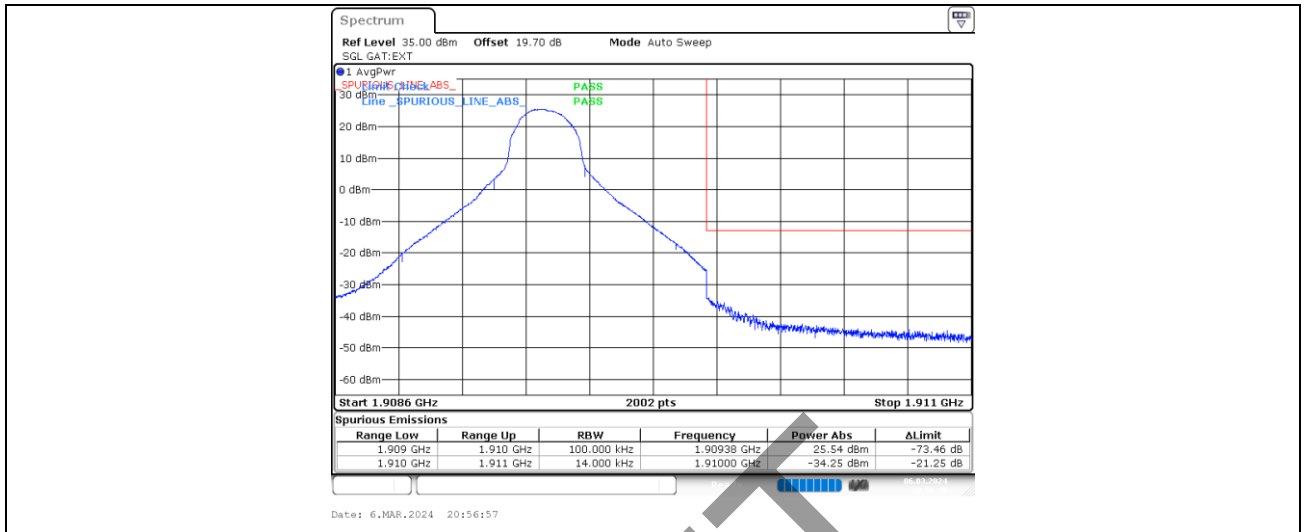

Band2-1.4MHz-QPSK-19193-1-5-High-1910.00--34.25-21.25-PASS

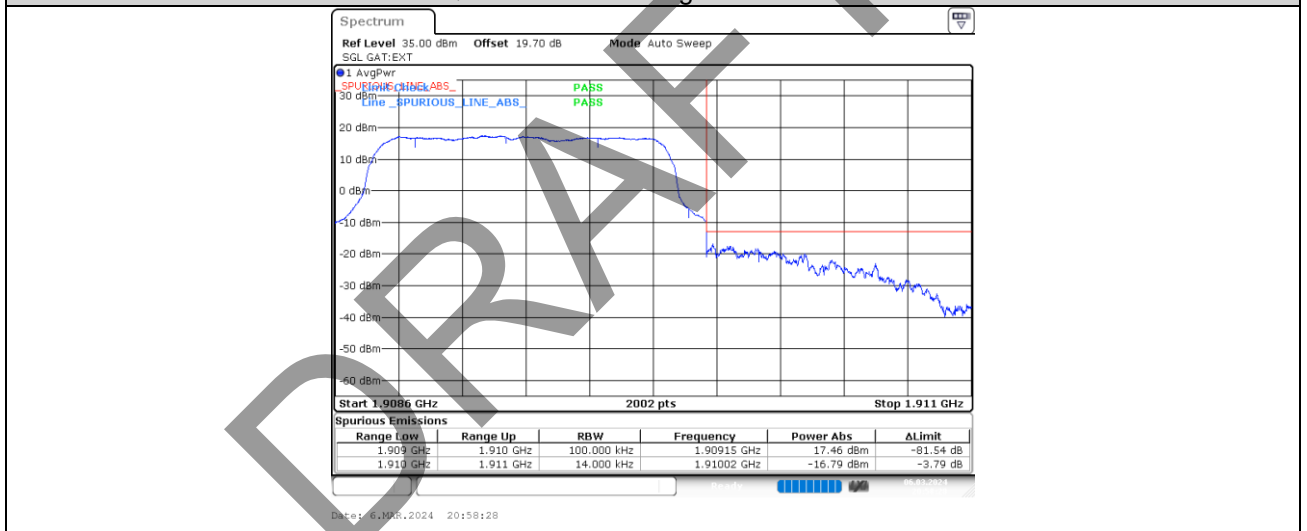

Band2-1.4MHz-QPSK-19193-6-0-High-1910.02--16.79-3.79-PASS

BV 7Layers Communications Technology (Shenzhen) Co., Ltd

Room B37, Warehouse A5, No.3 Chiwan 4th Road, Zhaoshang Street, Nanshan District Shenzhen, Guangdong, People's Republic of China

Tel: +86 755 8869 6566
Fax: +86 755 8869 6577
Email: customerservice.sw@bureauveritas.com



BUREAU VERITAS

Test Report No.: W7L-P23120015R102

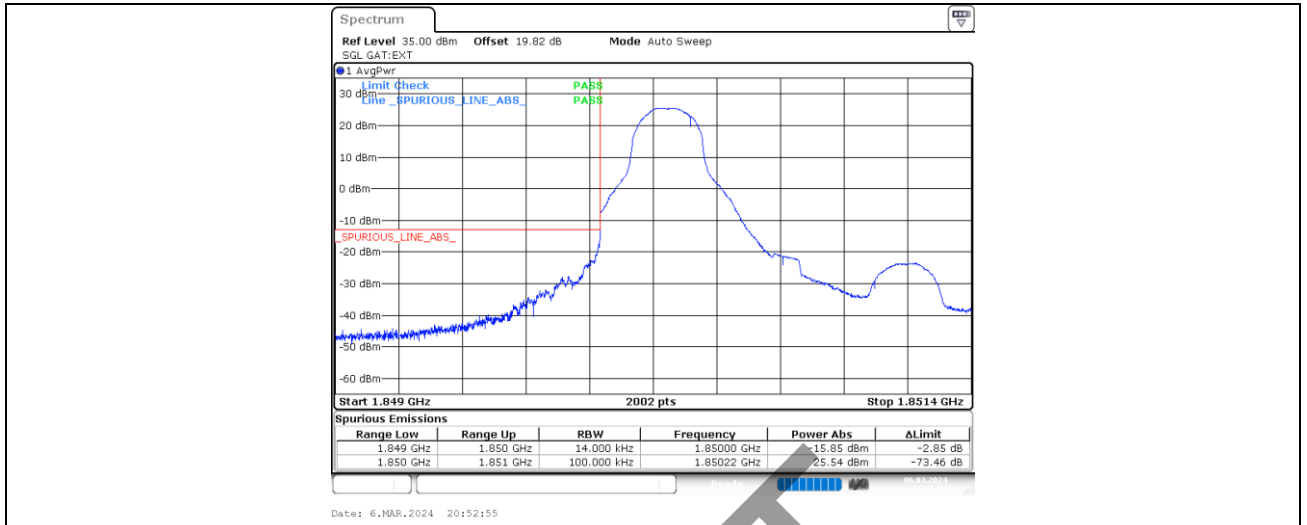

Band2-1.4MHz-16QAM-18607-1-0-Low-1850.00--15.85-2.85-PASS

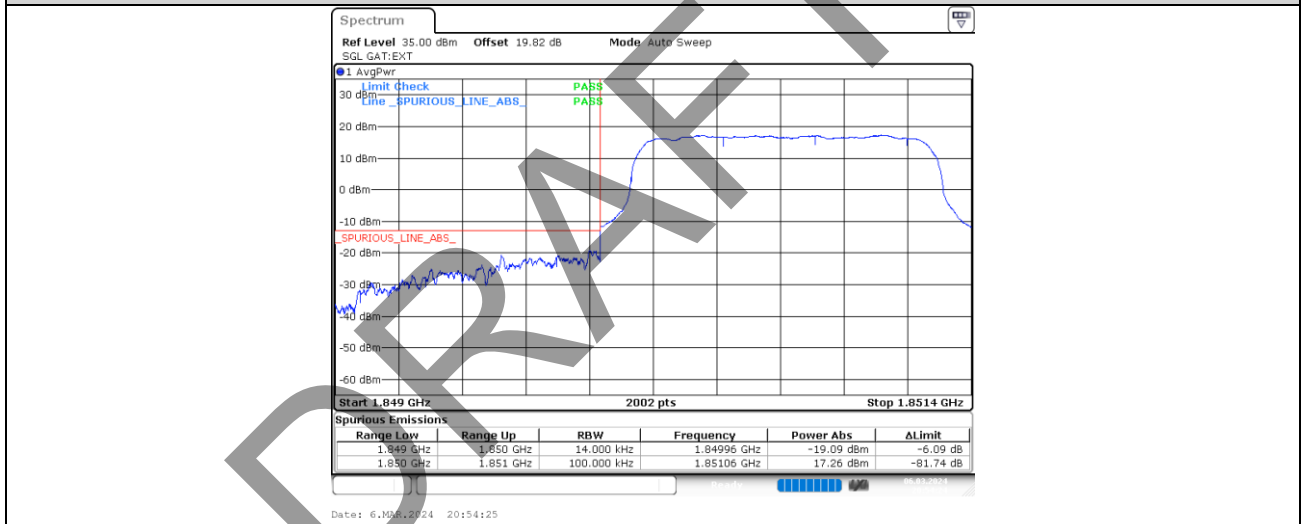

Band2-1.4MHz-16QAM-18607-6-0-Low-1849.96--19.09-6.09-PASS

BV 7Layers Communications Technology (Shenzhen) Co., Ltd

Room B37, Warehouse A5, No.3 Chiwan 4th Road, Zhaoshang Street, Nanshan District Shenzhen, Guangdong, People's Republic of China

Tel: +86 755 8869 6566
Fax: +86 755 8869 6577
Email: customerservice.sw@bureauveritas.com



BUREAU VERITAS

Test Report No.: W7L-P23120015R102

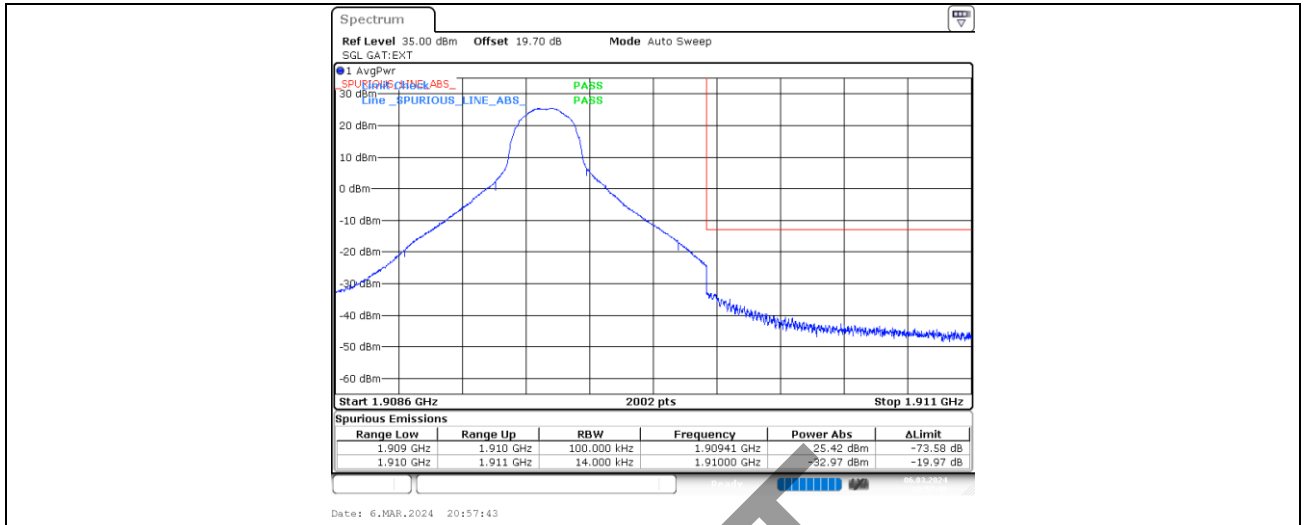

Band2-1.4MHz-16QAM-19193-1-5-High-1910.00--32.97-19.97-PASS



Band2-1.4MHz-16QAM-19193-6-0-High-1910.02--16.85-3.85-PASS

BV 7Layers Communications Technology (Shenzhen) Co., Ltd

Room B37, Warehouse A5, No.3 Chiwan 4th Road, Zhaoshang Street, Nanshan District Shenzhen, Guangdong, People's Republic of China

Tel: +86 755 8869 6566
Fax: +86 755 8869 6577
Email: customerservice.sw@bureauveritas.com



BUREAU VERITAS

Test Report No.: W7L-P23120015R102

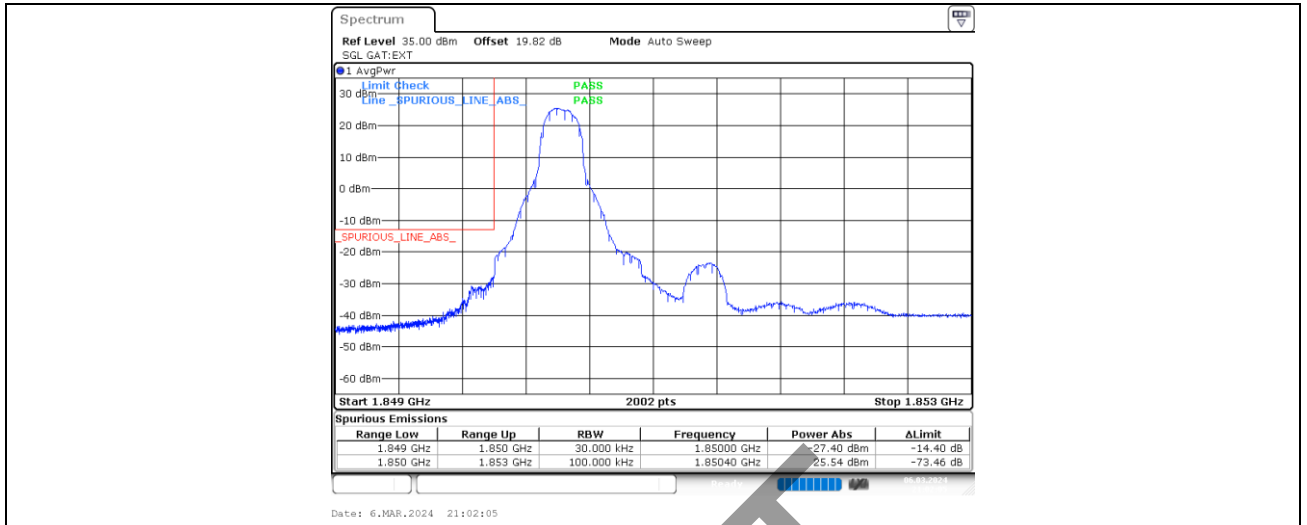

Band2-3MHz-QPSK-18615-1-0-Low-1850.00--27.40-14.40-PASS

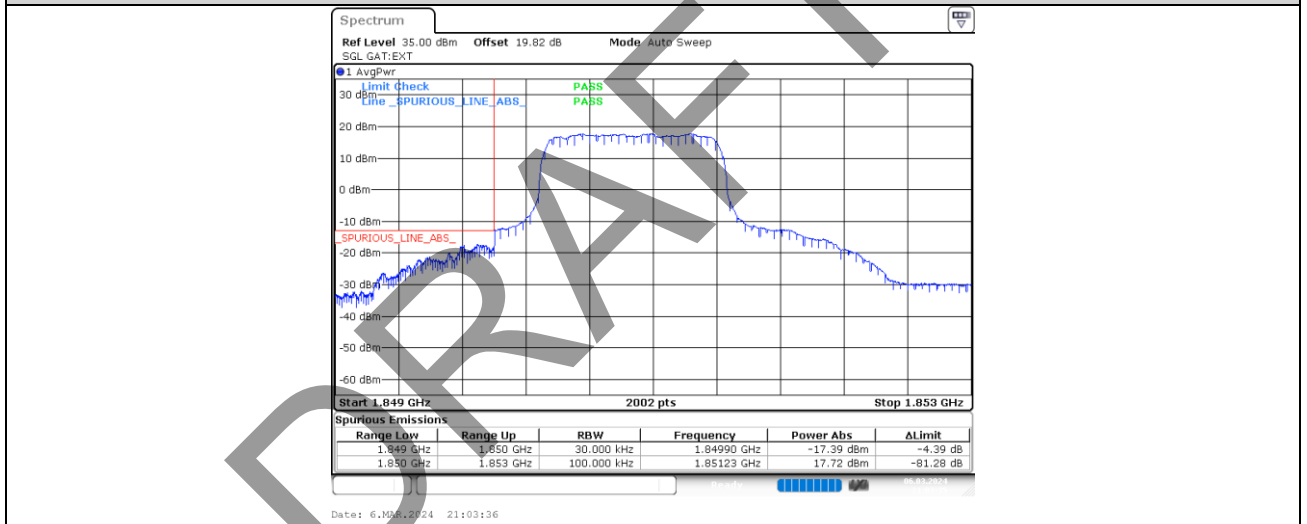

Band2-3MHz-QPSK-18615-6-0-Low-1849.90--17.39-4.39-PASS



BUREAU VERITAS

Test Report No.: W7L-P23120015R102

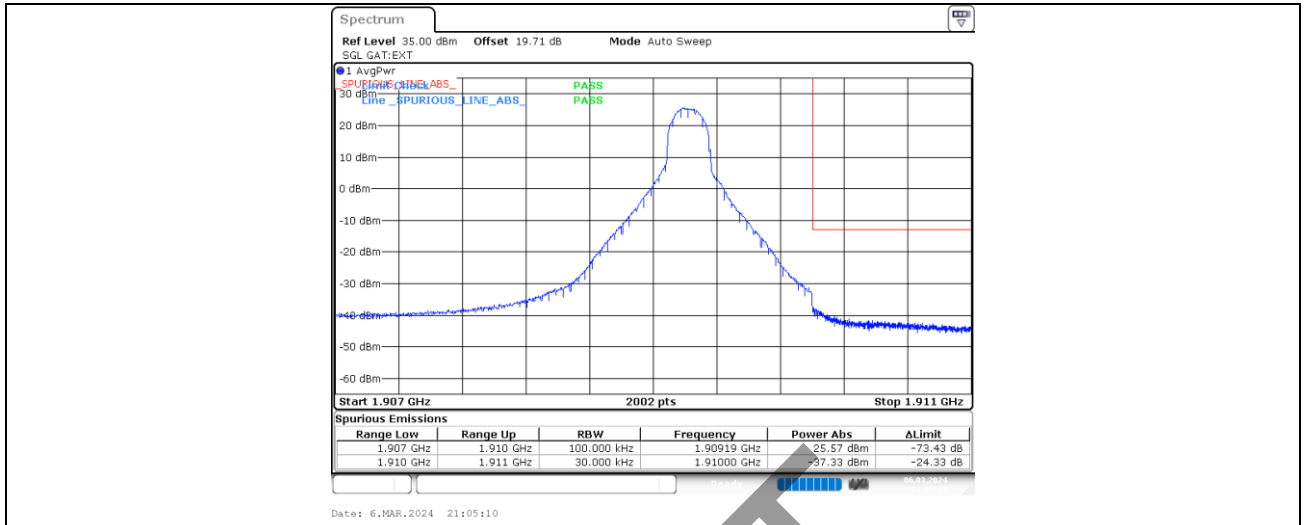

Band2-3MHz-QPSK-19185-1-5-High-1910.00--37.33-24.33-PASS

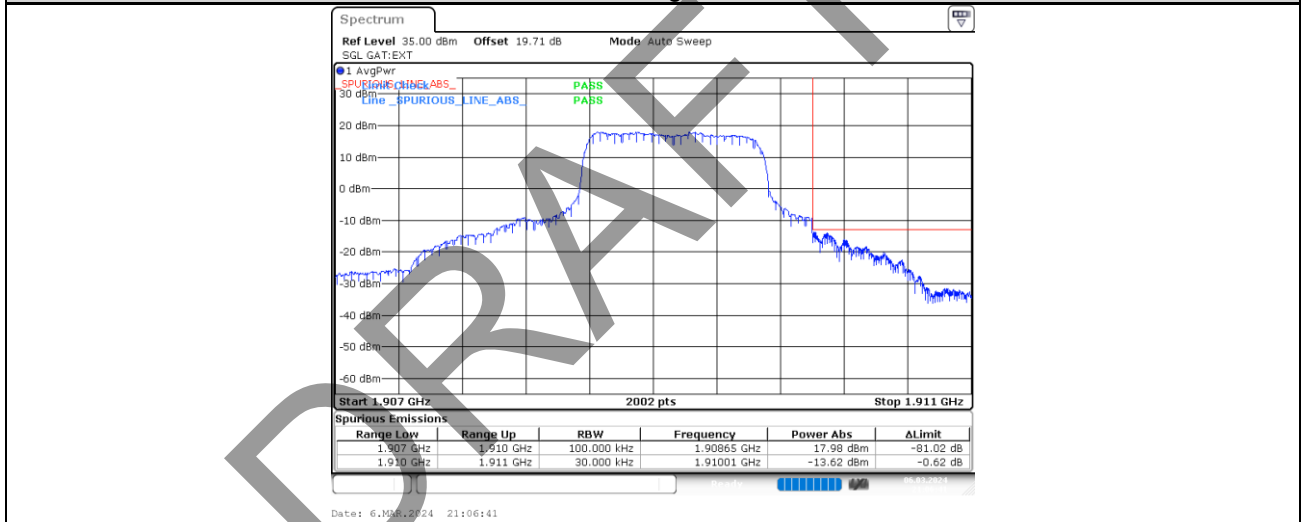

Band2-3MHz-QPSK-19185-6-0-High-1910.01--13.62-0.62-PASS

BV 7Layers Communications Technology (Shenzhen) Co., Ltd

Room B37, Warehouse A5, No.3 Chiwan 4th Road, Zhaoshang Street, Nanshan District Shenzhen, Guangdong, People's Republic of China

Tel: +86 755 8869 6566
Fax: +86 755 8869 6577
Email: customerservice.sw@bureauveritas.com



BUREAU VERITAS

Test Report No.: W7L-P23120015R102

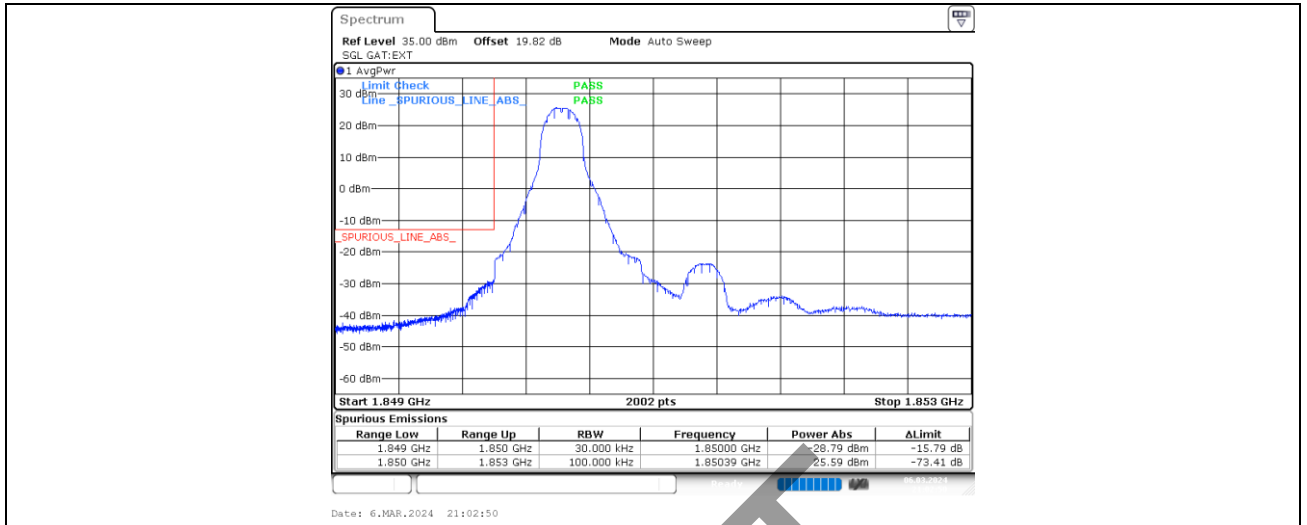

Band2-3MHz-16QAM-18615-1-0-Low-1850.00--28.79-15.79-PASS

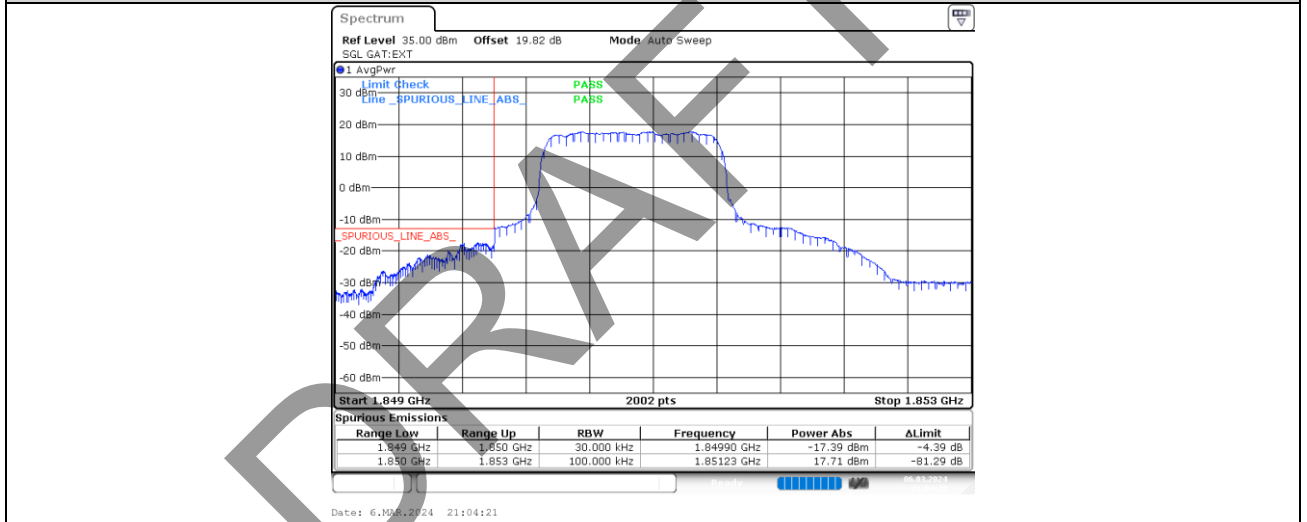

Band2-3MHz-16QAM-18615-6-0-Low-1849.90--17.39-4.39-PASS



BUREAU VERITAS

Test Report No.: W7L-P23120015R102

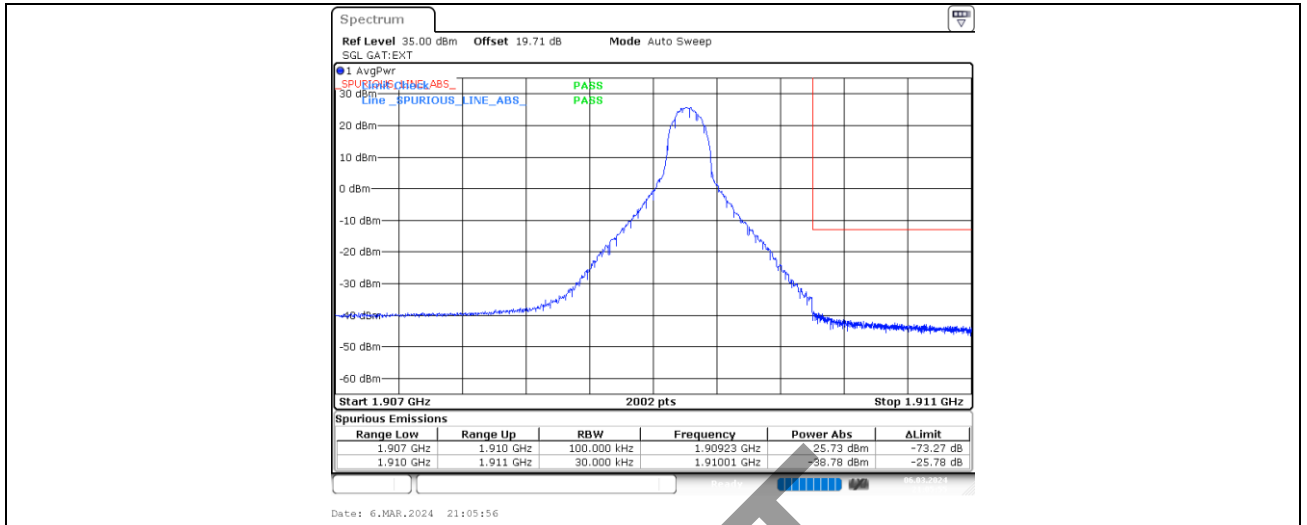

Band2-3MHz-16QAM-19185-1-5-High-1910.01--38.78-25.78-PASS

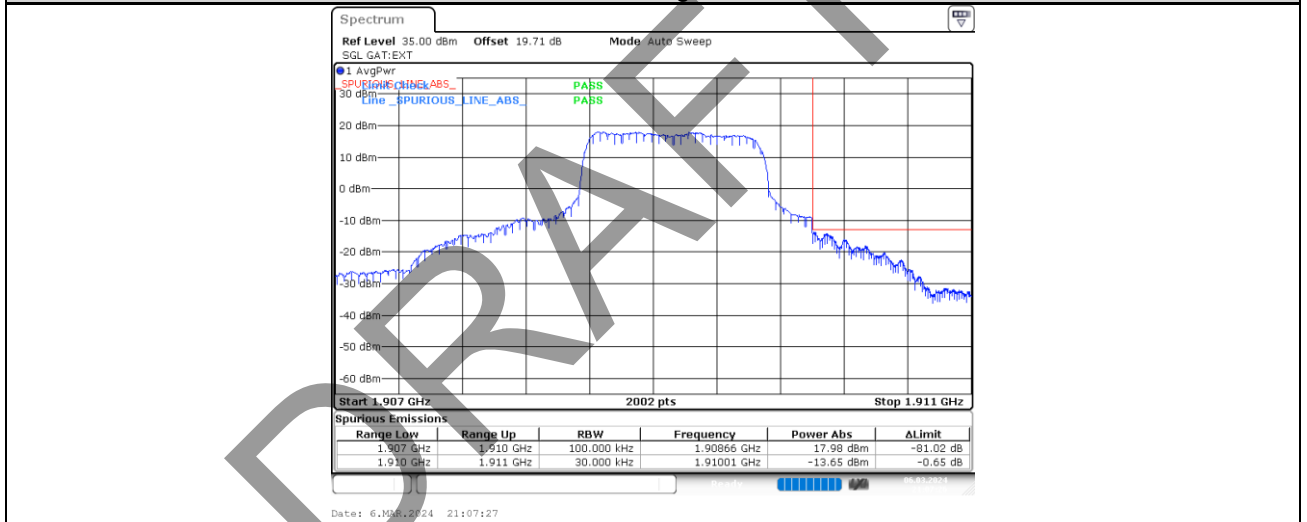

Band2-3MHz-16QAM-19185-6-0-High-1910.01--13.65-0.65-PASS

BV 7Layers Communications Technology (Shenzhen) Co., Ltd

Room B37, Warehouse A5, No.3 Chiwan 4th Road, Zhaoshang Street, Nanshan District Shenzhen, Guangdong, People's Republic of China

Tel: +86 755 8869 6566

Fax: +86 755 8869 6577

Email: customerservice.sw@bureauveritas.com



BUREAU VERITAS

Test Report No.: W7L-P23120015R102

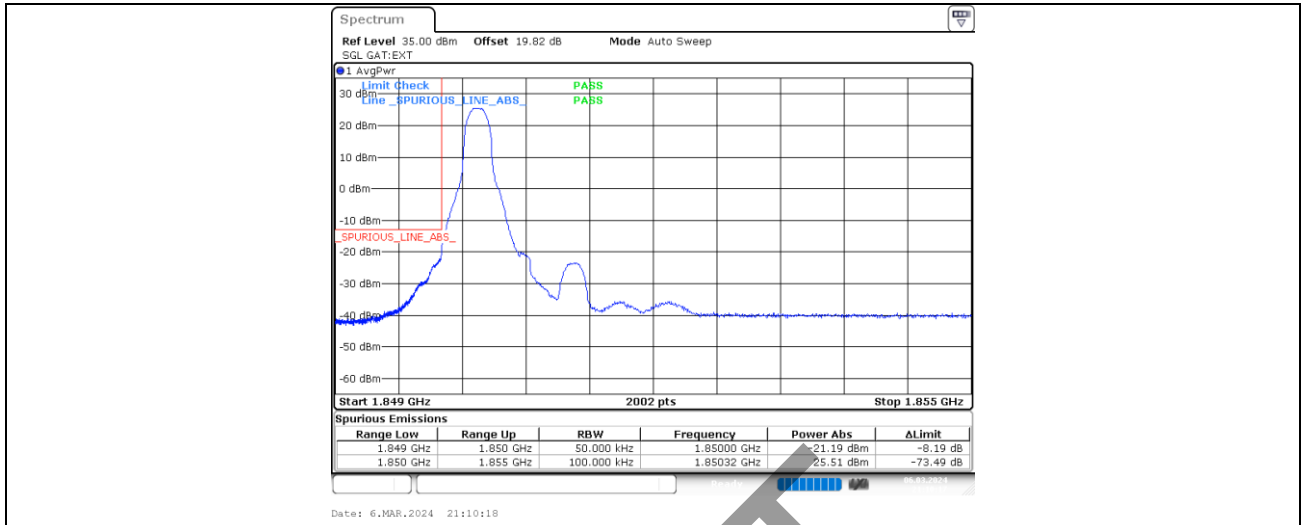

Band2-5MHz-QPSK-18625-1-0-Low-1850.00--21.19-8.19-PASS

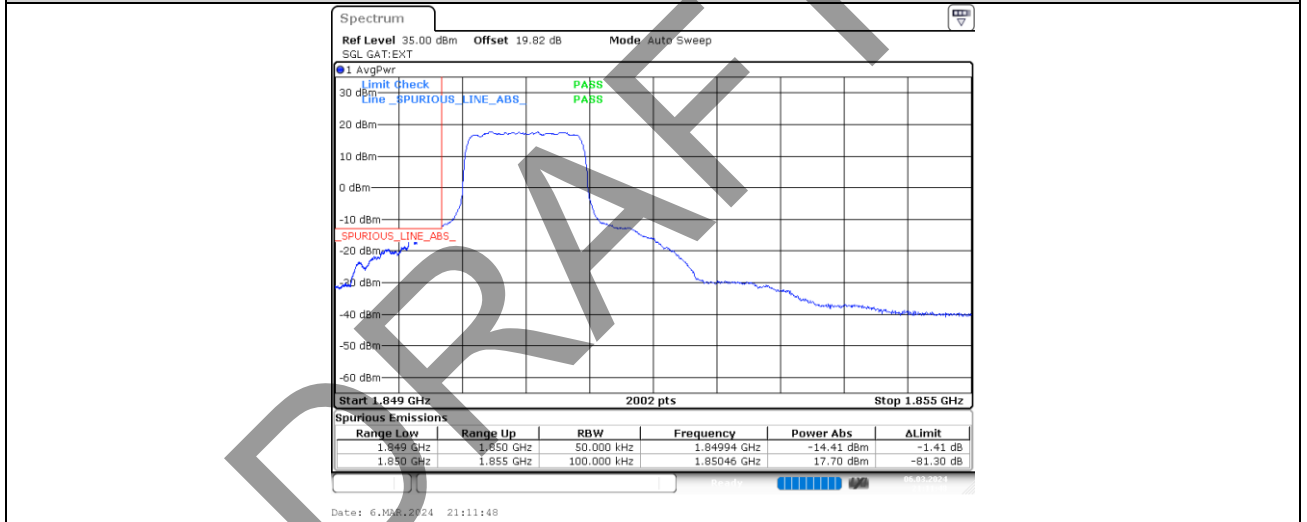

Band2-5MHz-QPSK-18625-6-0-Low-1849.94--14.41-1.41-PASS

BV 7Layers Communications Technology (Shenzhen) Co., Ltd

Room B37, Warehouse A5, No.3 Chiwan 4th Road, Zhaoshang Street, Nanshan District Shenzhen, Guangdong, People's Republic of China

Tel: +86 755 8869 6566
Fax: +86 755 8869 6577
Email: customerservice.sw@bureauveritas.com

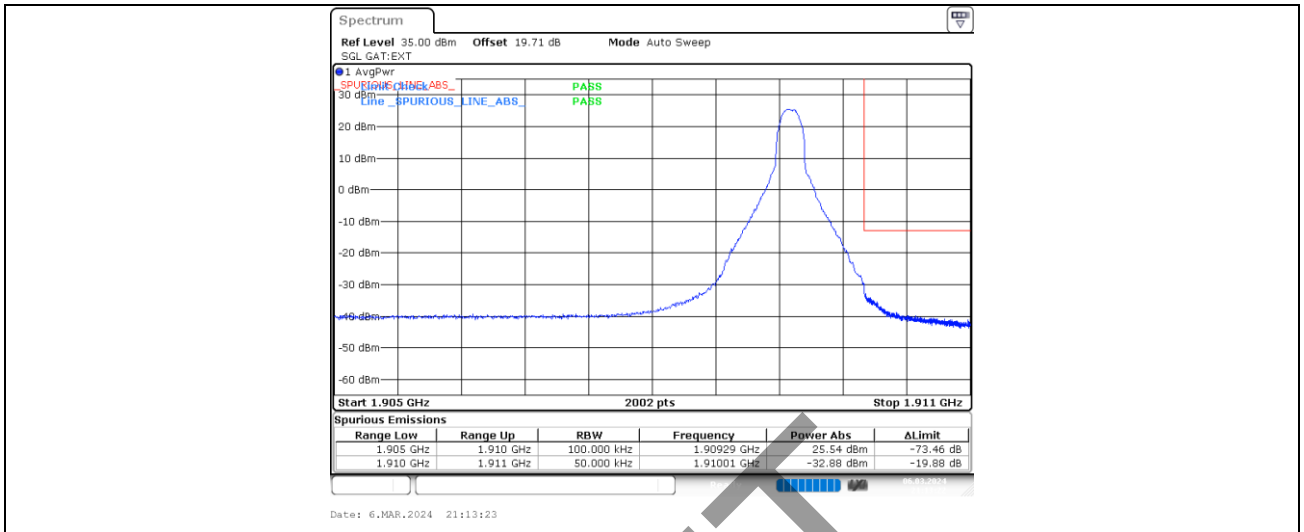

Band2-5MHz-QPSK-19175-1-5-High-1910.01--32.88-19.88-PASS

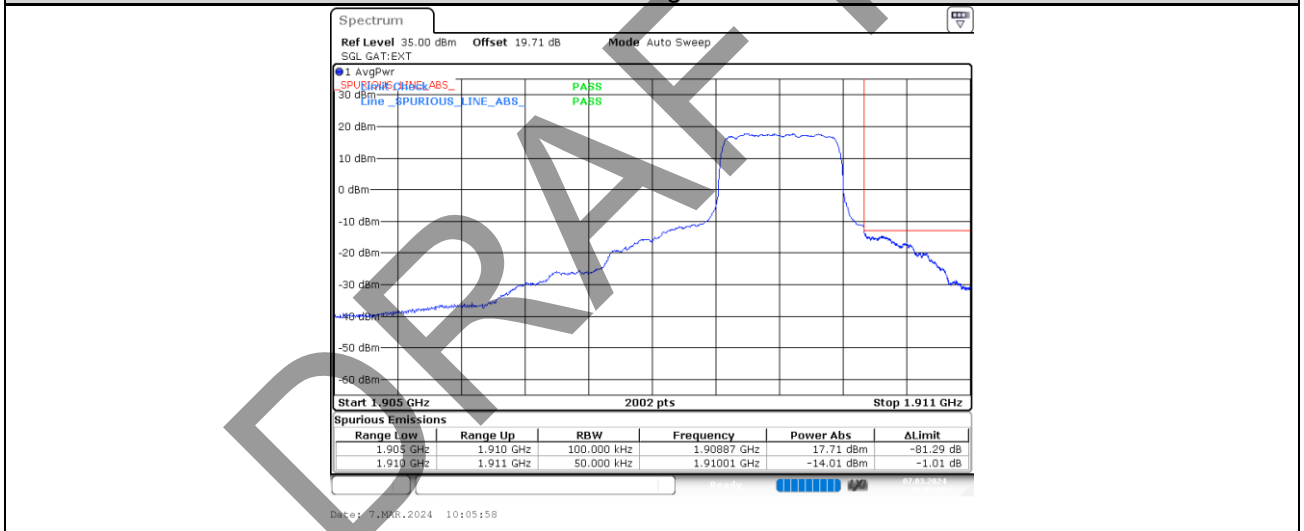

Band2-5MHz-QPSK-19175-6-0-High-1910.01--14.01-1.01-PASS

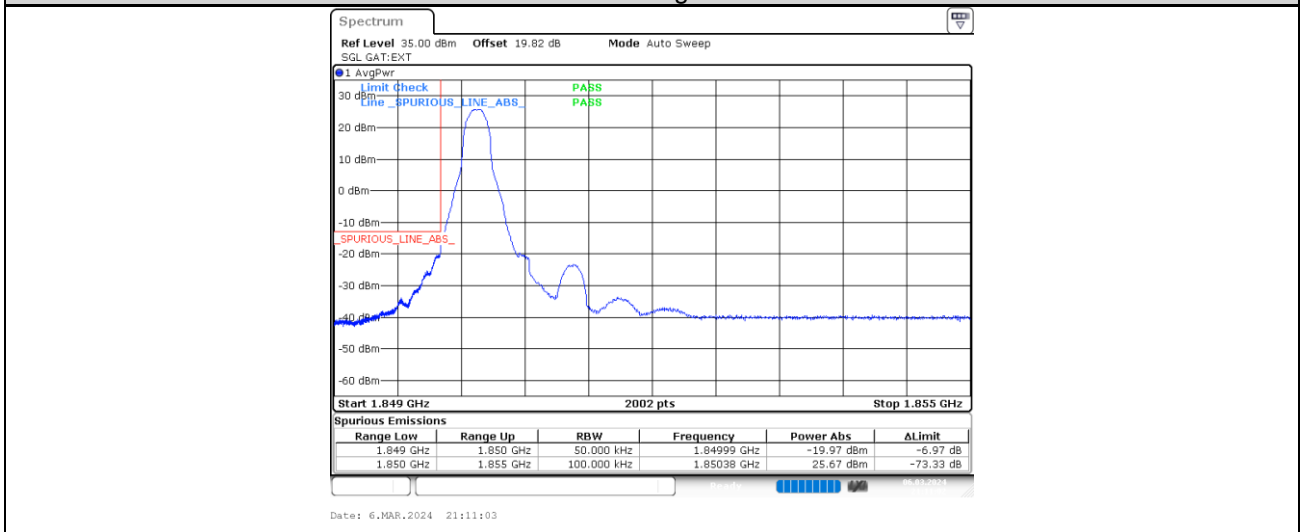

Band2-5MHz-16QAM-18625-1-0-Low-1849.99--19.97-6.97-PASS



BUREAU VERITAS

Test Report No.: W7L-P23120015R102

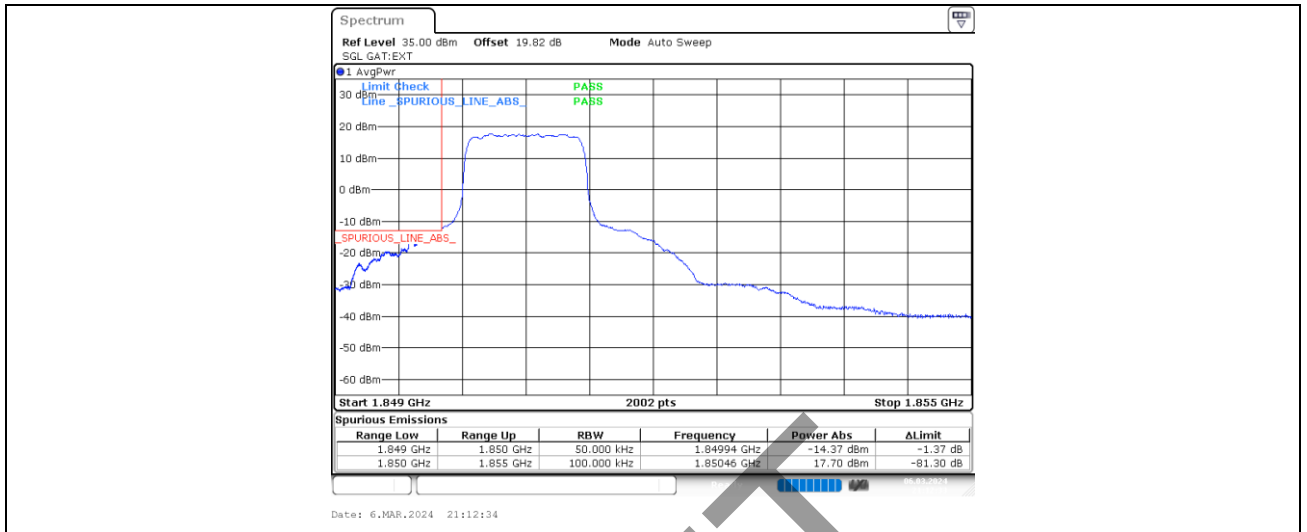

Band2-5MHz-16QAM-18625-6-0-Low-1849.94--14.37-1.37-PASS

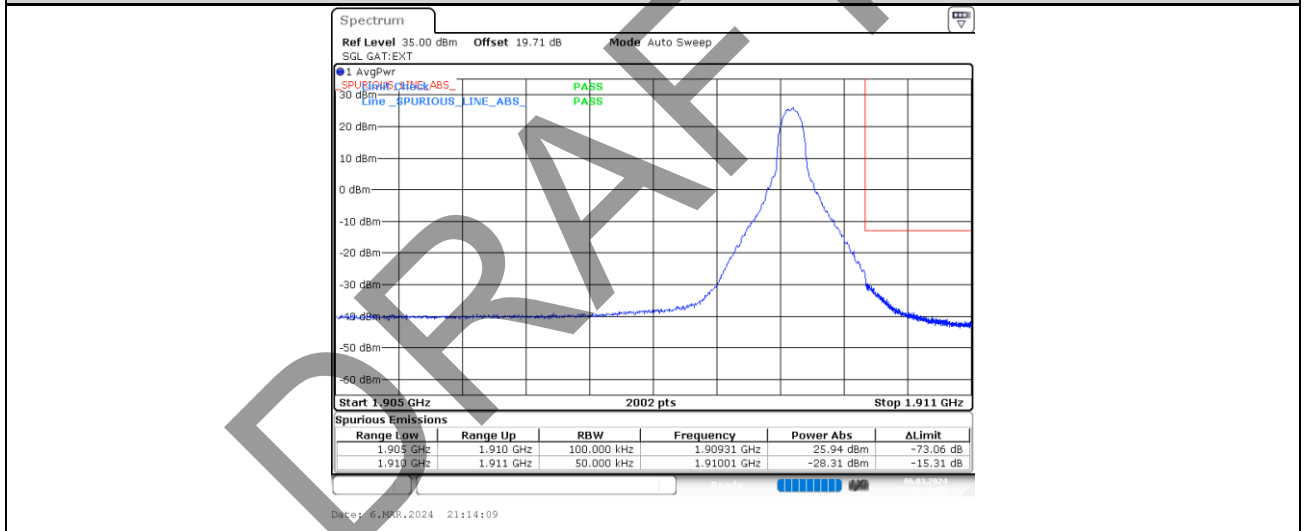

Band2-5MHz-16QAM-19175-1-5-High-1910.01--28.31-15.31-PASS



BUREAU VERITAS

Test Report No.: W7L-P23120015R102

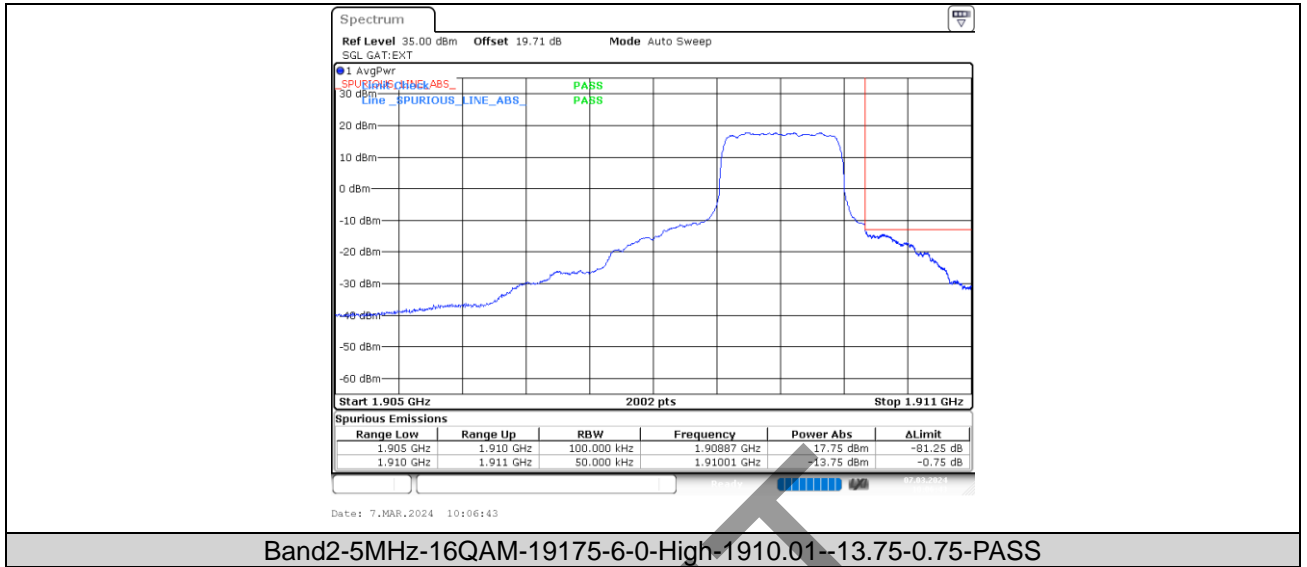

DRAFT



BUREAU VERITAS

Test Report No.: W7L-P23120015R102

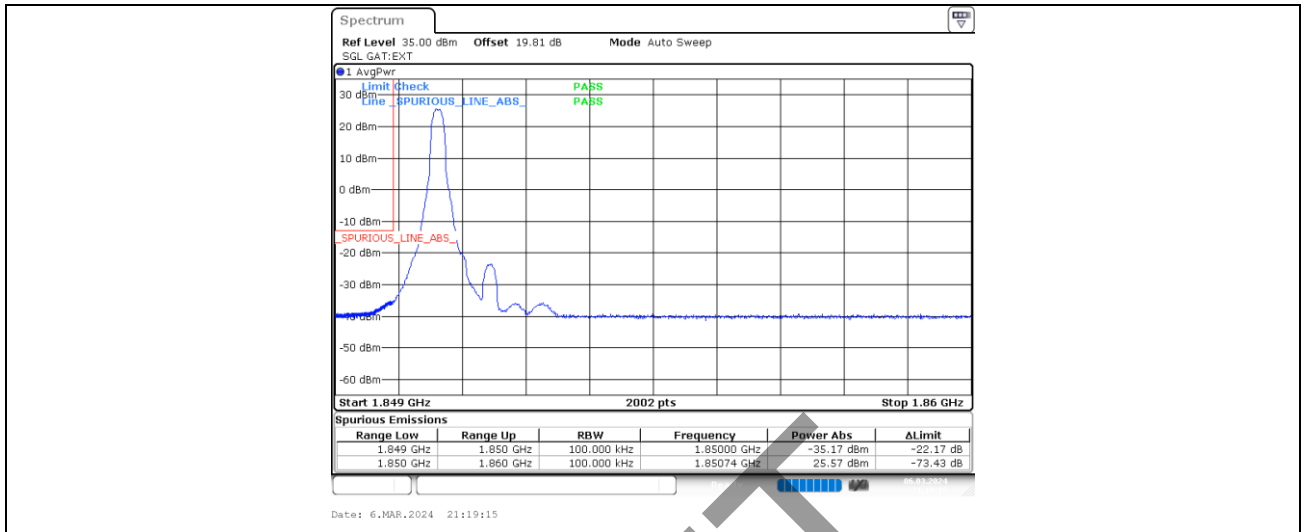

Band2-10MHz-QPSK-18650-1-0-Low-1850.00--35.17-22.17-PASS

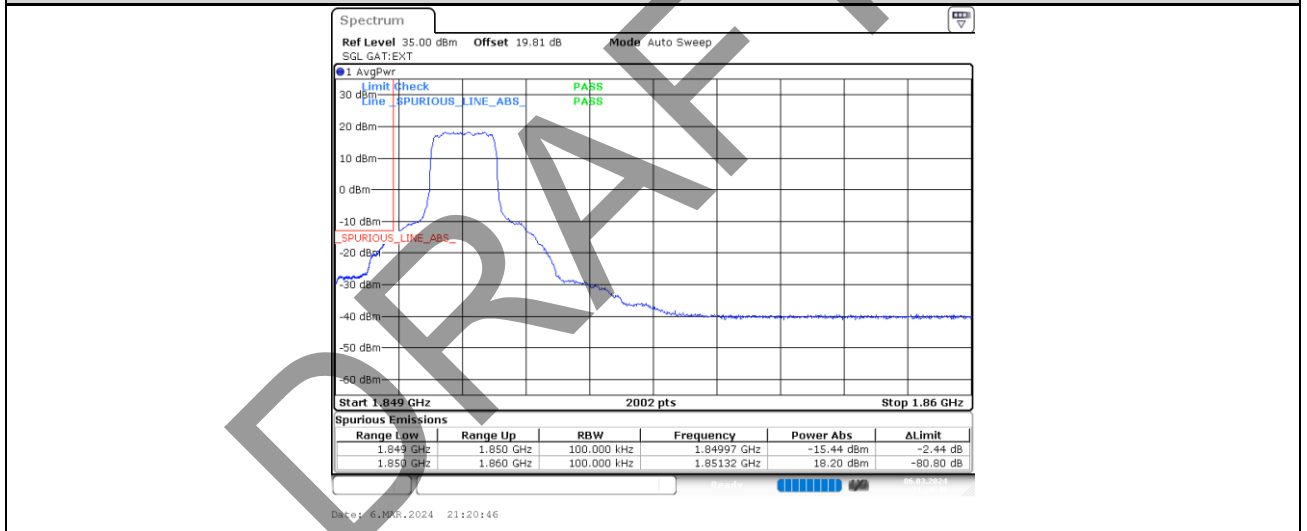

Band2-10MHz-QPSK-18650-6-0-Low-1849.97--15.44-2.44-PASS



BUREAU VERITAS

Test Report No.: W7L-P23120015R102

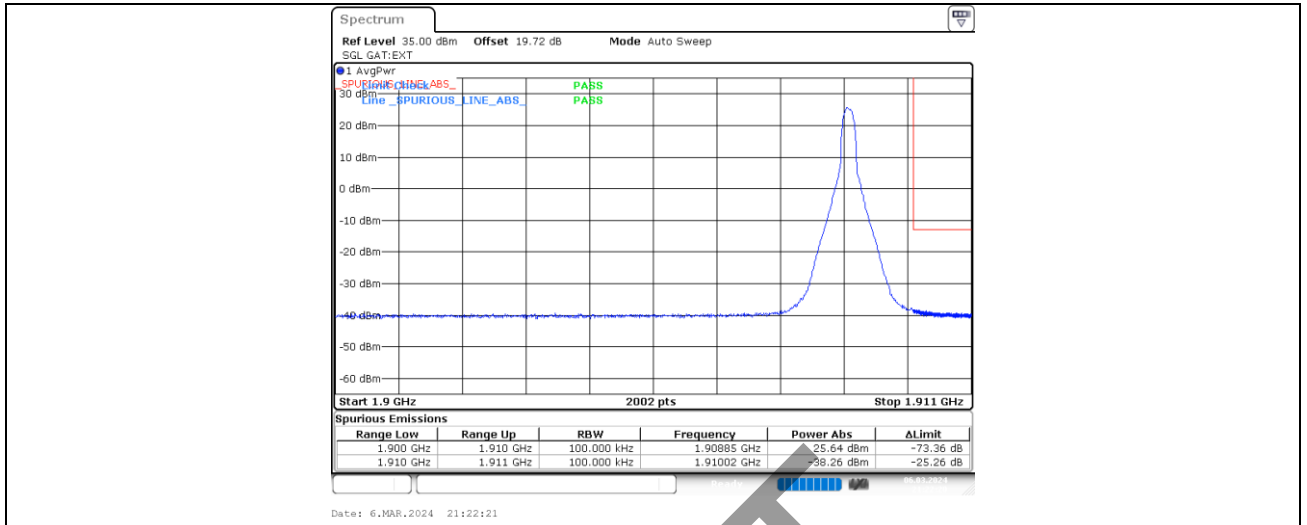

Band2-10MHz-QPSK-19150-1-5-High-1910.02--38.26-25.26-PASS

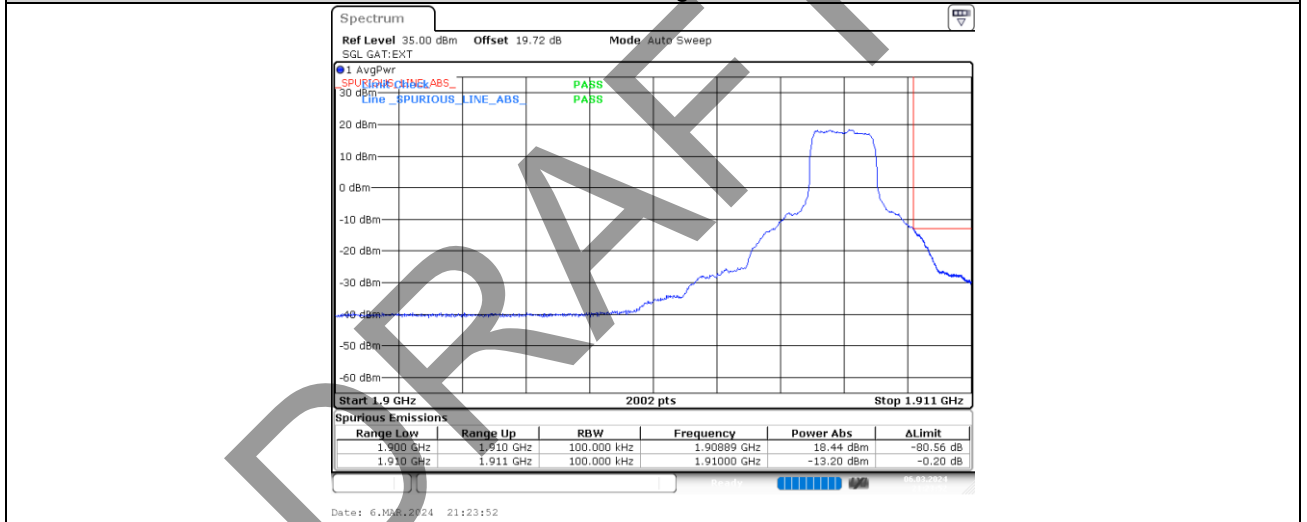

Band2-10MHz-QPSK-19150-6-0-High-1910.00--13.20-0.20-PASS

BV 7Layers Communications Technology (Shenzhen) Co., Ltd

Room B37, Warehouse A5, No.3 Chiwan 4th Road, Zhaoshang Street, Nanshan District Shenzhen, Guangdong, People's Republic of China

Tel: +86 755 8869 6566
Fax: +86 755 8869 6577
Email: customerservice.sw@bureauveritas.com



BUREAU VERITAS

Test Report No.: W7L-P23120015R102

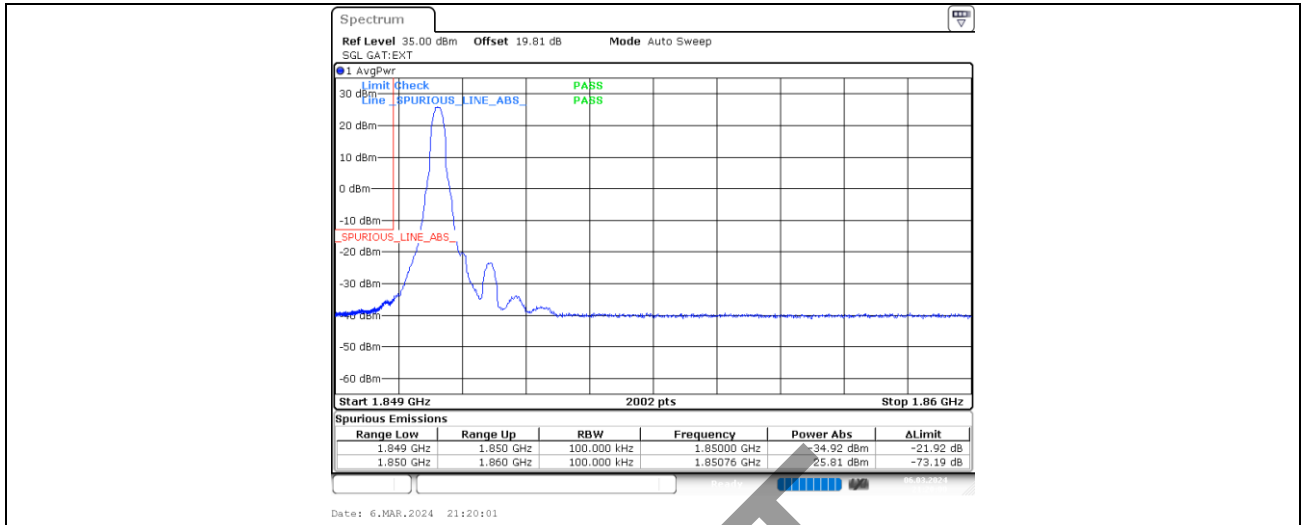

Band2-10MHz-16QAM-18650-1-0-Low-1850.00--34.92-21.92-PASS

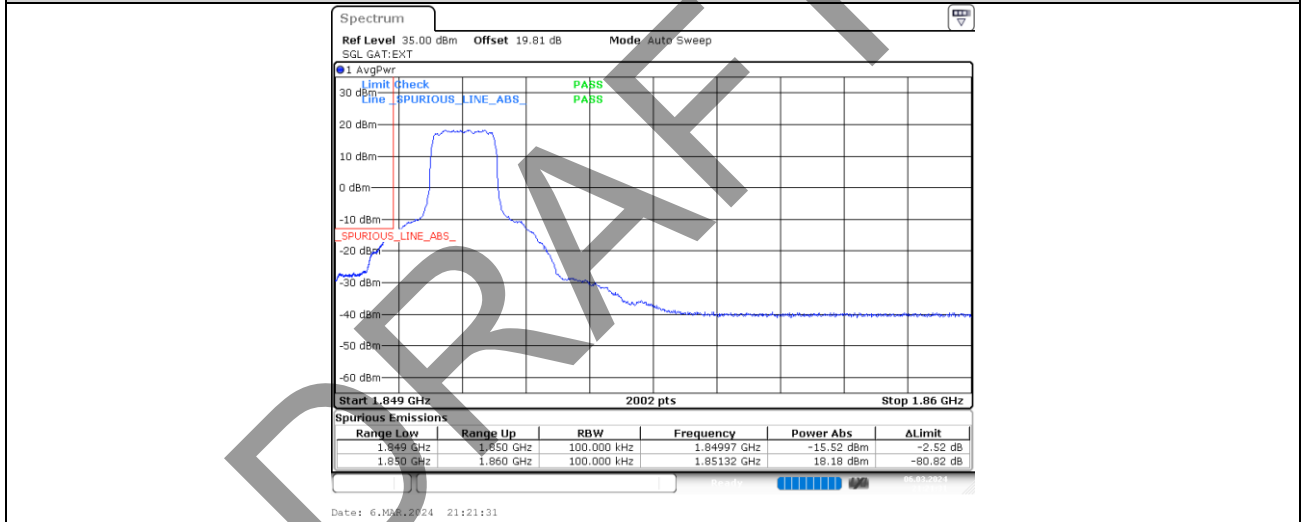

Band2-10MHz-16QAM-18650-6-0-Low-1849.97--15.52-2.52-PASS

BV 7Layers Communications Technology (Shenzhen) Co., Ltd

Room B37, Warehouse A5, No.3 Chiwan 4th Road, Zhaoshang Street, Nanshan District Shenzhen, Guangdong, People's Republic of China

Tel: +86 755 8869 6566

Fax: +86 755 8869 6577

Email: customerservice.sw@bureauveritas.com



BUREAU VERITAS

Test Report No.: W7L-P23120015R102

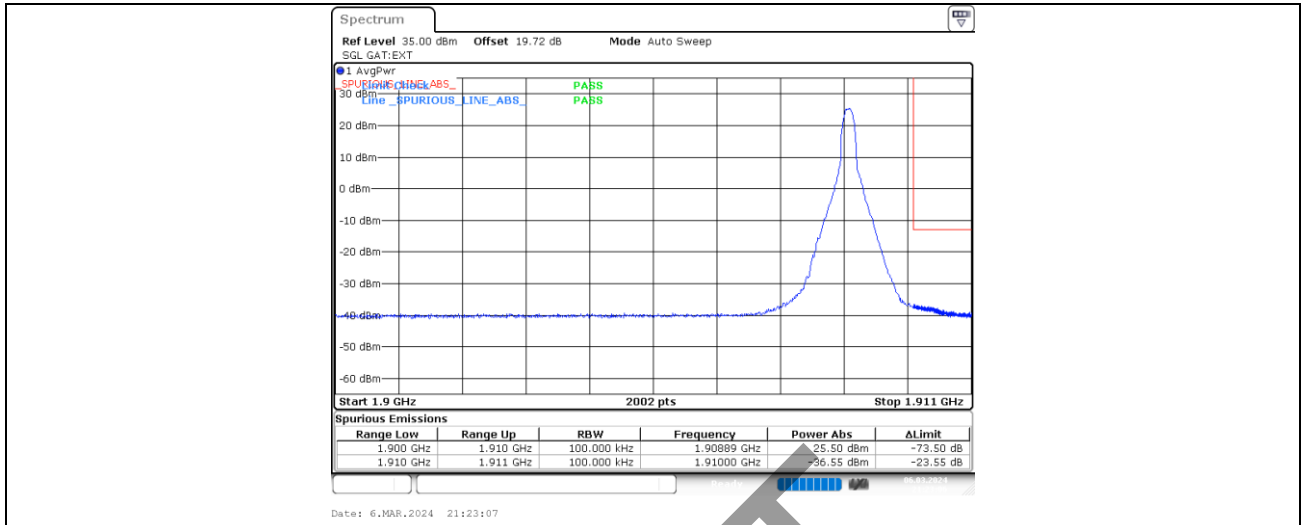

Band2-10MHz-16QAM-19150-1-5-High-1910.00--36.55-23.55-PASS

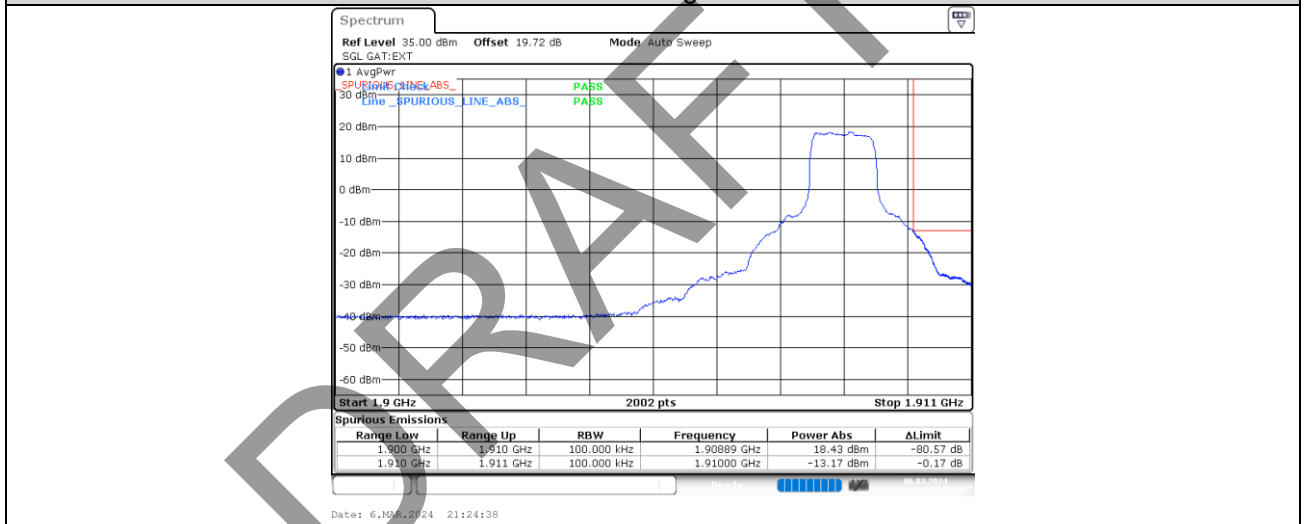

Band2-10MHz-16QAM-19150-6-0-High-1910.00--13.17-0.17-PASS

BV 7Layers Communications Technology (Shenzhen) Co., Ltd

Room B37, Warehouse A5, No.3 Chiwan 4th Road, Zhaoshang Street, Nanshan District Shenzhen, Guangdong, People's Republic of China

Tel: +86 755 8869 6566 Fax: +86 755 8869 6577 Email: customerservice.sw@bureauveritas.com



BUREAU VERITAS

Test Report No.: W7L-P23120015R102

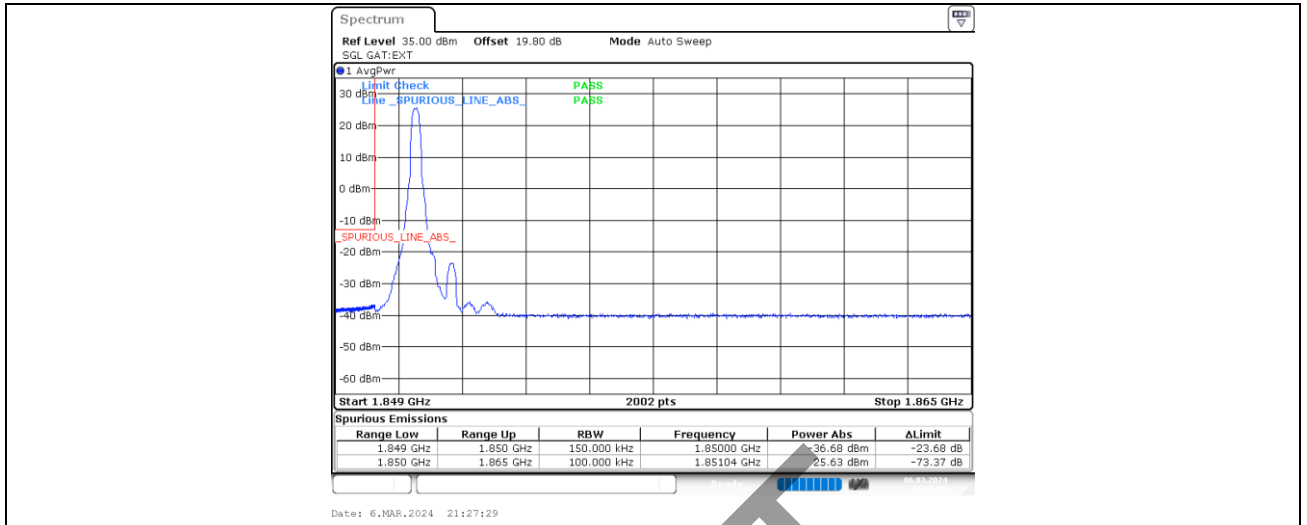

Band2-15MHz-QPSK-18675-1-0-Low-1850.00--36.68-23.68-PASS

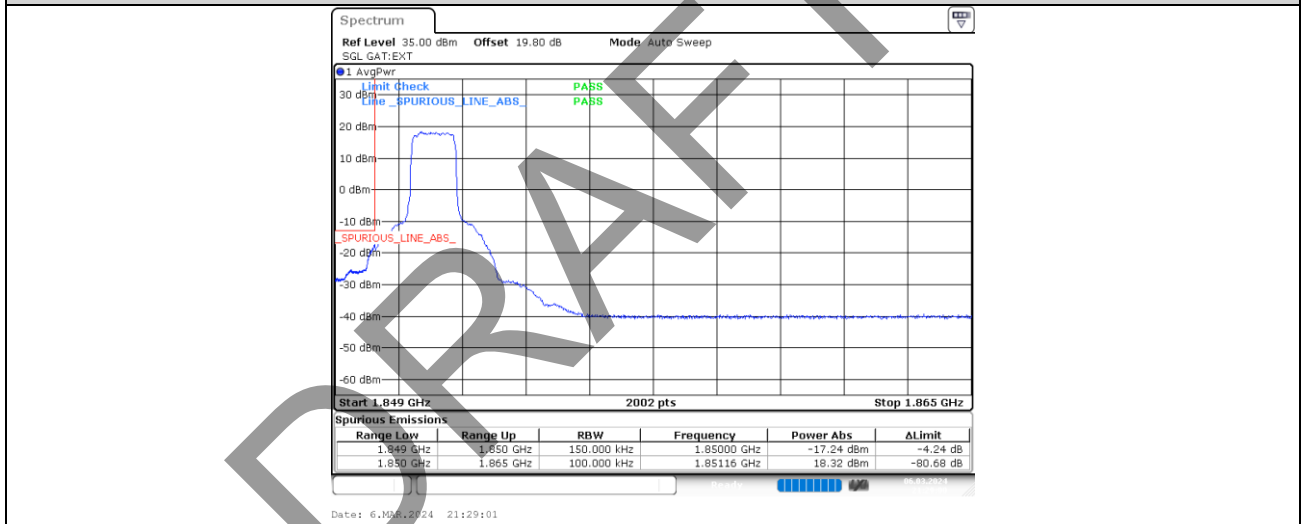

Band2-15MHz-QPSK-18675-6-0-Low-1850.00--17.24-4.24-PASS



BUREAU VERITAS

Test Report No.: W7L-P23120015R102

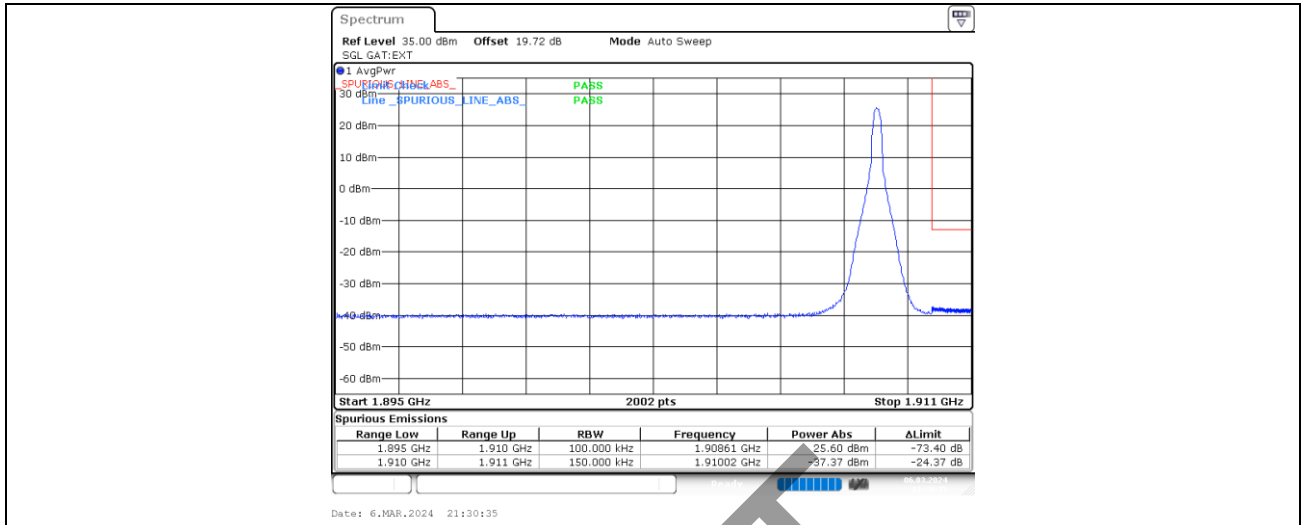

Band2-15MHz-QPSK-19125-1-5-High-1910.02--37.37-24.37-PASS

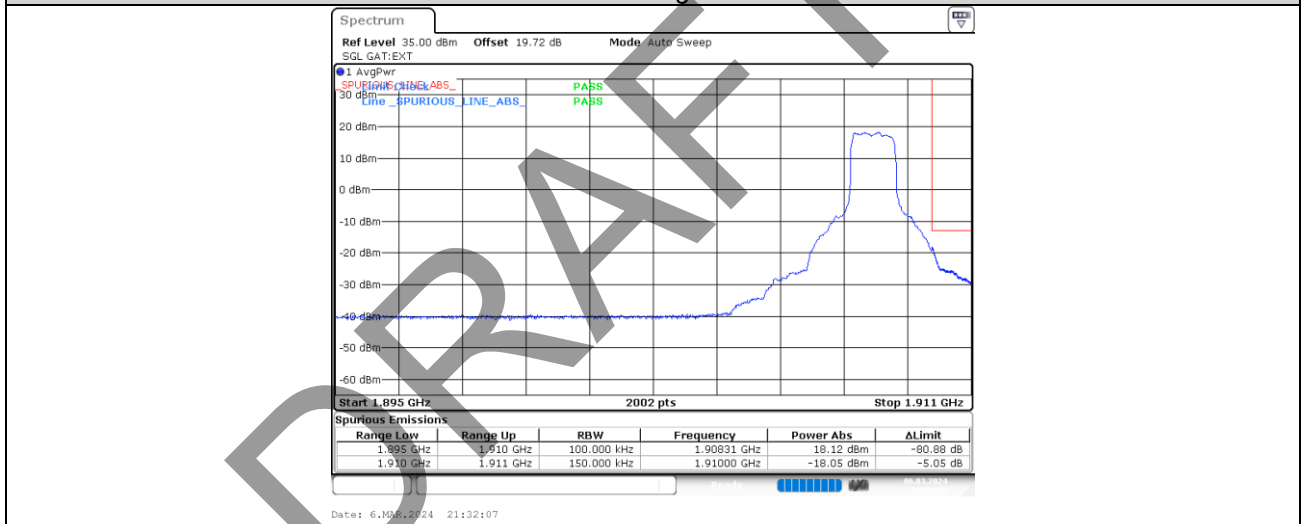

Band2-15MHz-QPSK-19125-6-0-High-1910.00--18.05-5.05-PASS

BV 7Layers Communications Technology (Shenzhen) Co., Ltd

Room B37, Warehouse A5, No.3 Chiwan 4th Road, Zhaoshang Street, Nanshan District Shenzhen, Guangdong, People's Republic of China

Tel: +86 755 8869 6566 Fax: +86 755 8869 6577 Email: customerservice.sw@bureauveritas.com



BUREAU VERITAS

Test Report No.: W7L-P23120015R102

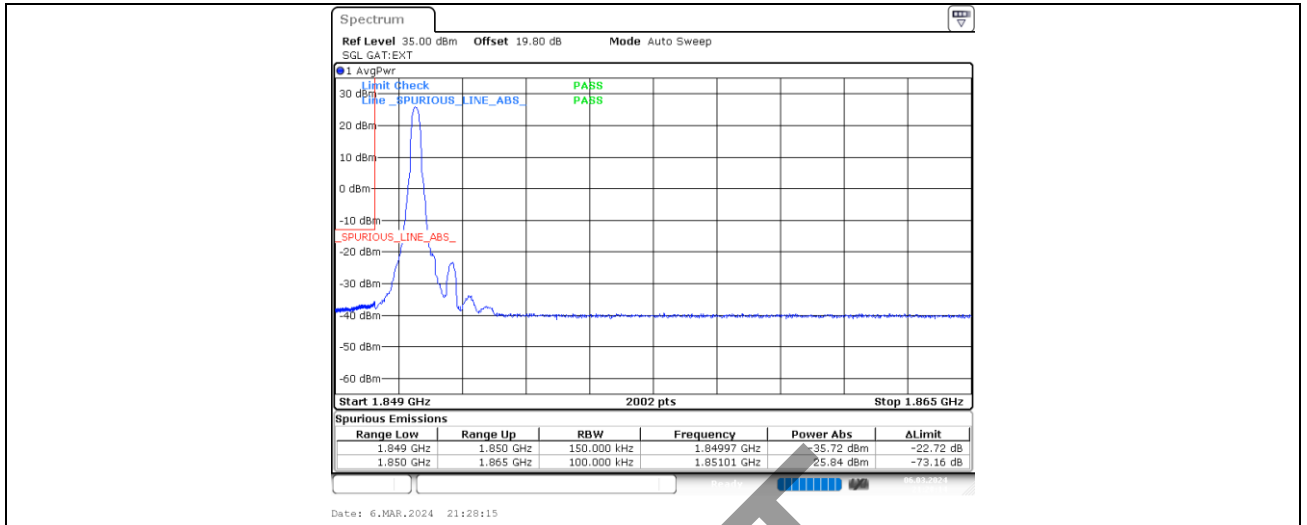

Band2-15MHz-16QAM-18675-1-0-Low-1849.97--35.72-22.72-PASS

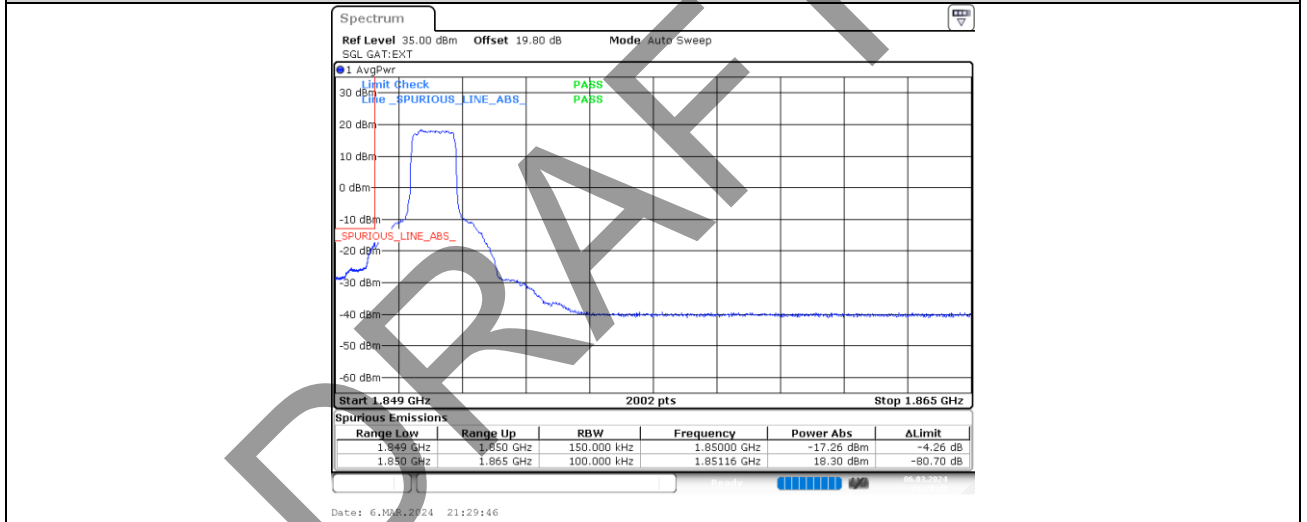

Band2-15MHz-16QAM-18675-6-0-Low-1850.00--17.26-4.26-PASS

BV 7Layers Communications Technology (Shenzhen) Co., Ltd

Room B37, Warehouse A5, No.3 Chiwan 4th Road, Zhaoshang Street, Nanshan District Shenzhen, Guangdong, People's Republic of China

Tel: +86 755 8869 6566
Fax: +86 755 8869 6577
Email: customerservice.sw@bureauveritas.com



BUREAU VERITAS

Test Report No.: W7L-P23120015R102

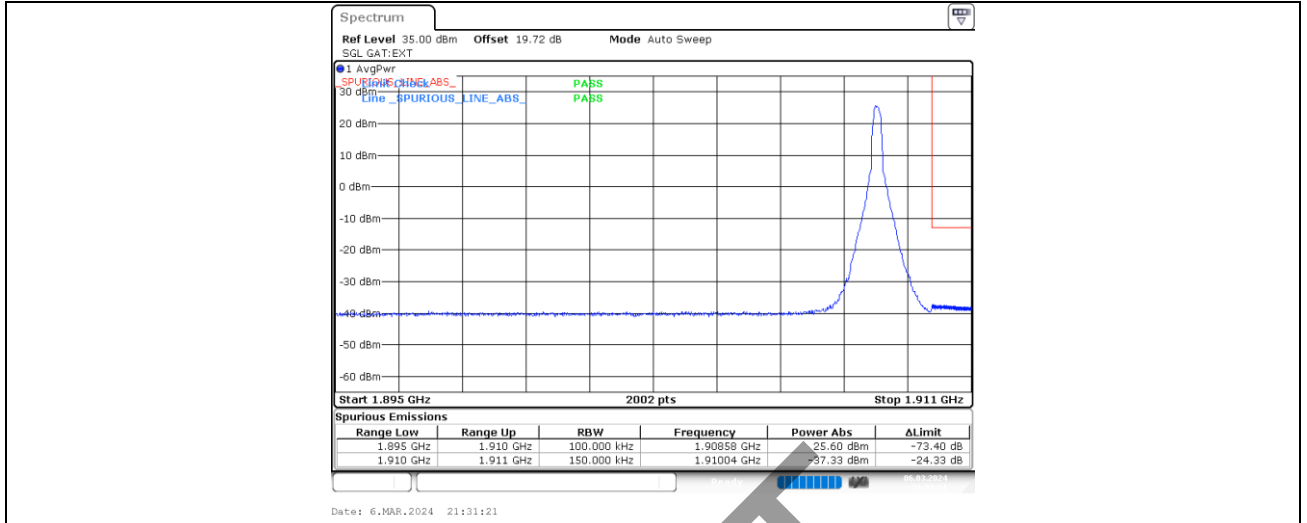

Band2-15MHz-16QAM-19125-1-5-High-1910.04--37.33-24.33-PASS

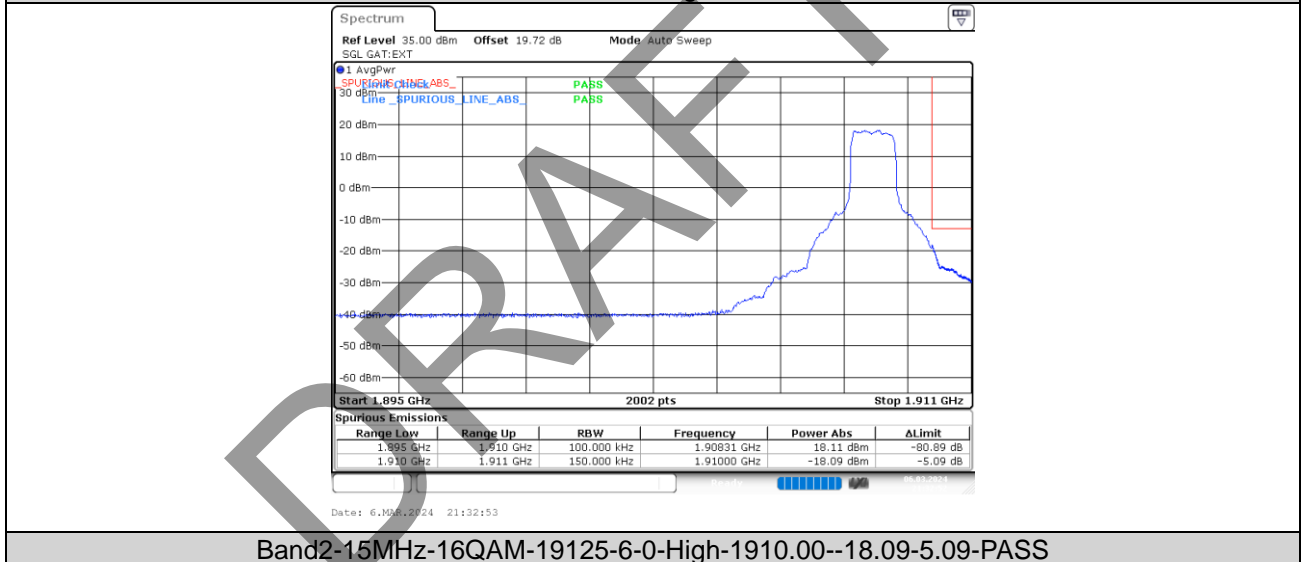

Band2-15MHz-16QAM-19125-6-0-High-1910.00--18.09-5.09-PASS

BV 7Layers Communications Technology (Shenzhen) Co., Ltd

Room B37, Warehouse A5, No.3 Chiwan 4th Road, Zhaoshang Street, Nanshan District Shenzhen, Guangdong, People's Republic of China

Tel: +86 755 8869 6566 Fax: +86 755 8869 6577 Email: customerservice.sw@bureauveritas.com



BUREAU VERITAS

Test Report No.: W7L-P23120015R102

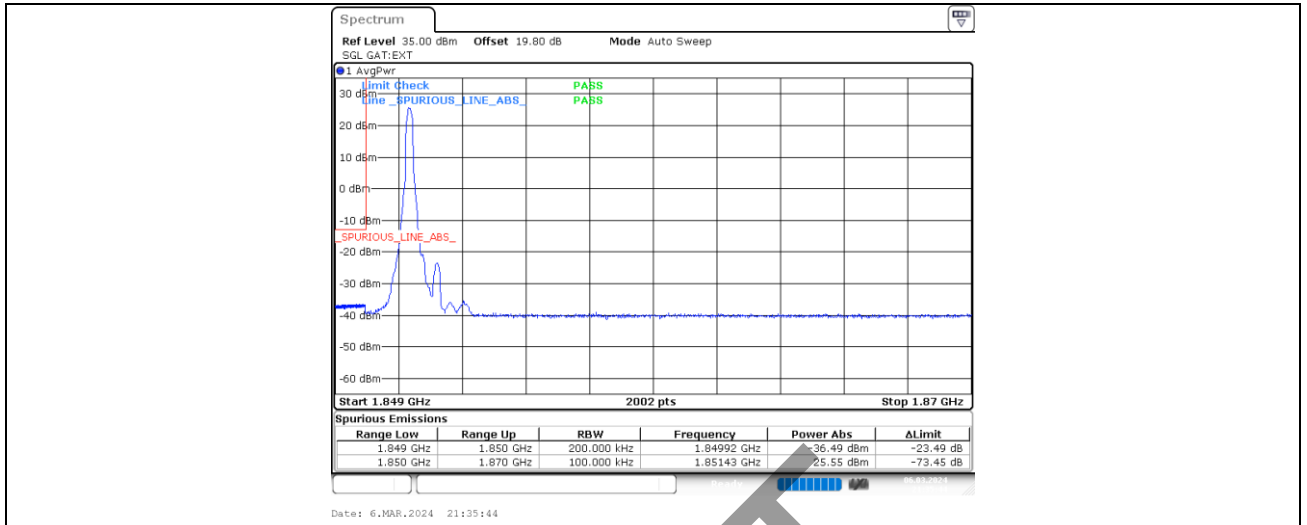

Band2-20MHz-QPSK-18700-1-0-Low-1849.92--36.49-23.49-PASS

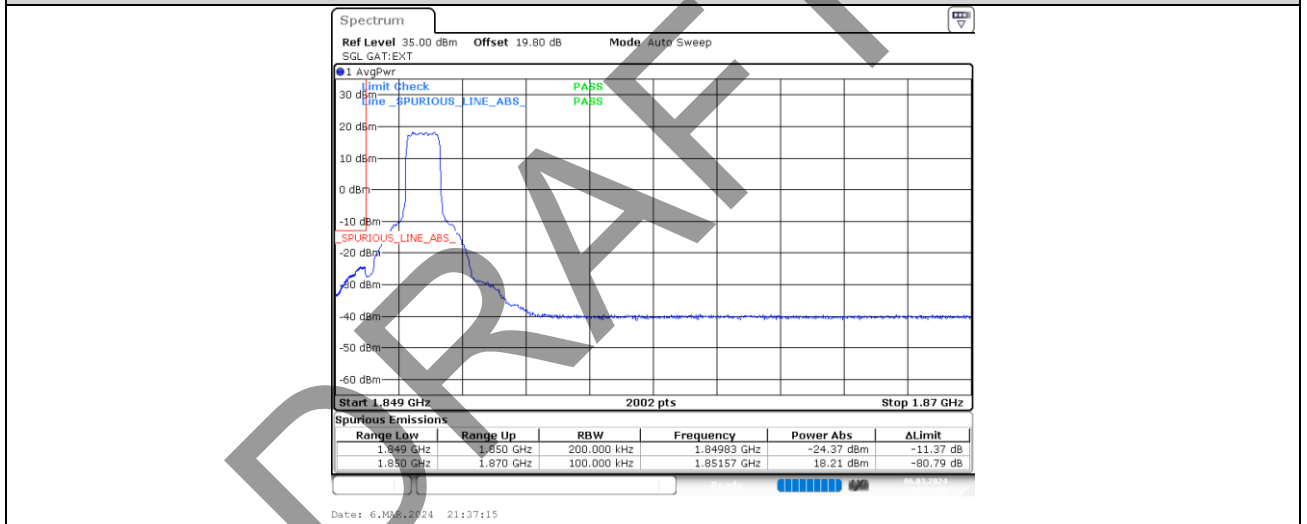

Band2-20MHz-QPSK-18700-6-0-Low-1849.83--24.37-11.37-PASS

BV 7Layers Communications Technology (Shenzhen) Co., Ltd

Room B37, Warehouse A5, No.3 Chiwan 4th Road, Zhaoshang Street, Nanshan District Shenzhen, Guangdong, People's Republic of China

Tel: +86 755 8869 6566
Fax: +86 755 8869 6577
Email: customerservice.sw@bureauveritas.com



BUREAU VERITAS

Test Report No.: W7L-P23120015R102

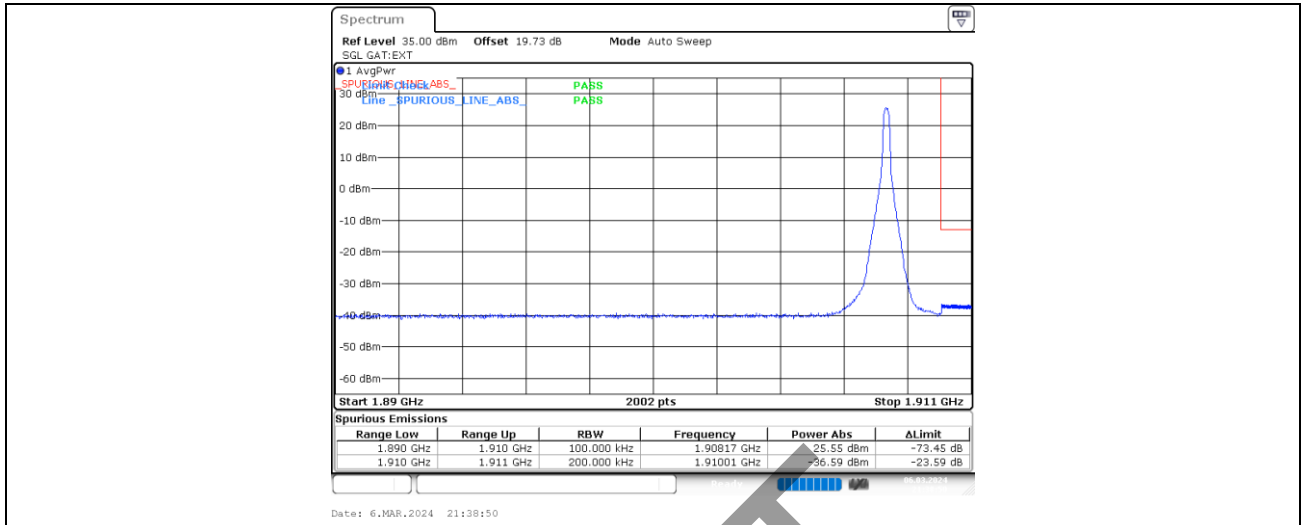

Band2-20MHz-QPSK-19100-1-5-High-1910.01--36.59-23.59-PASS

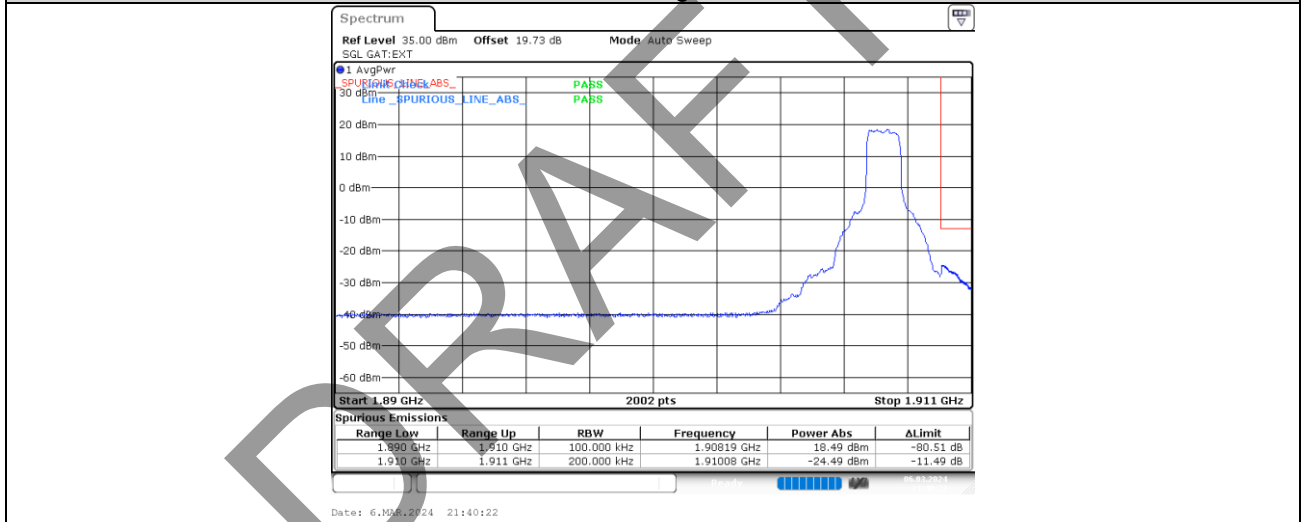

Band2-20MHz-QPSK-19100-6-0-High-1910.08--24.49-11.49-PASS

BV 7Layers Communications Technology (Shenzhen) Co., Ltd

Room B37, Warehouse A5, No.3 Chiwan 4th Road, Zhaoshang Street, Nanshan District Shenzhen, Guangdong, People's Republic of China

Tel: +86 755 8869 6566 Fax: +86 755 8869 6577 Email: customerservice.sw@bureauveritas.com



BUREAU VERITAS

Test Report No.: W7L-P23120015R102

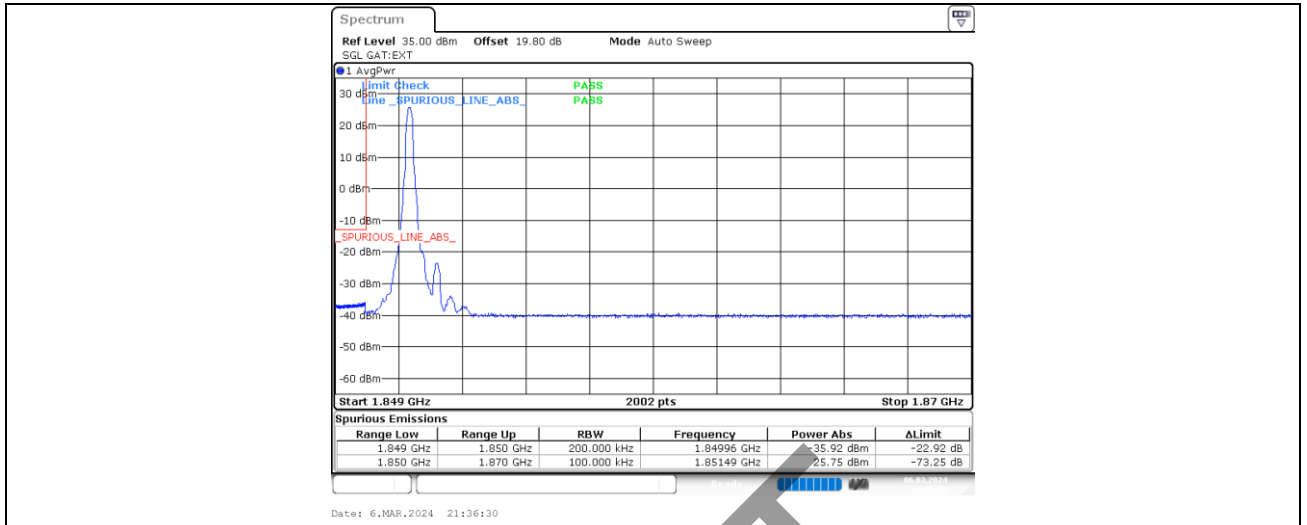

Band2-20MHz-16QAM-18700-1-0-Low-1849.96--35.92-22.92-PASS

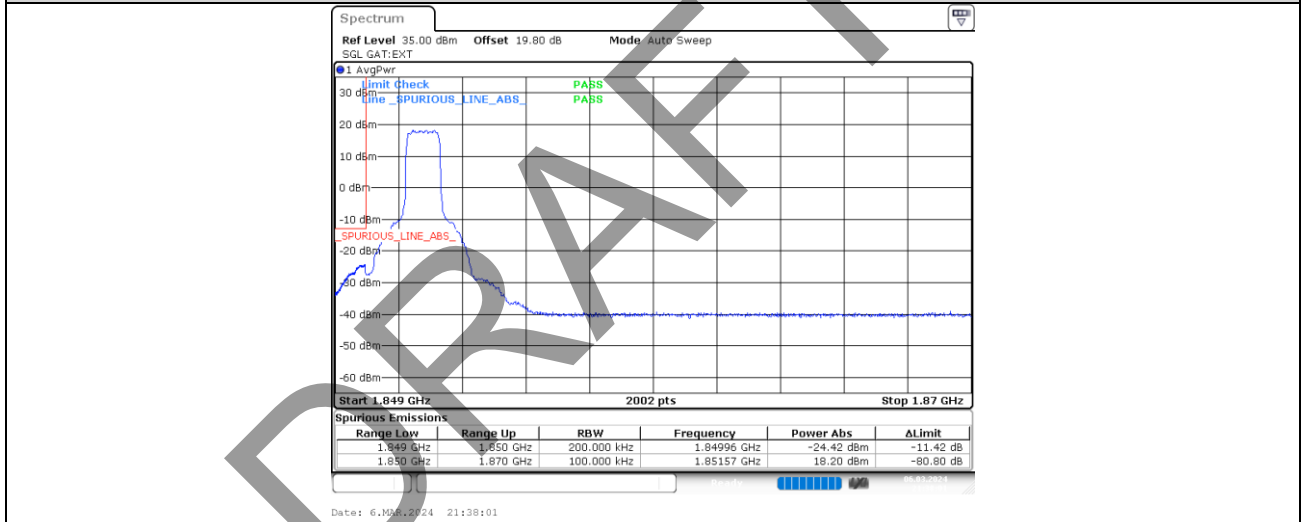

Band2-20MHz-16QAM-18700-6-0-Low-1849.96--24.42-11.42-PASS

BV 7Layers Communications Technology (Shenzhen) Co., Ltd

Room B37, Warehouse A5, No.3 Chiwan 4th Road, Zhaoshang Street, Nanshan District Shenzhen, Guangdong, People's Republic of China

Tel: +86 755 8869 6566
Fax: +86 755 8869 6577
Email: customerservice.sw@bureauveritas.com



BUREAU VERITAS

Test Report No.: W7L-P23120015R102

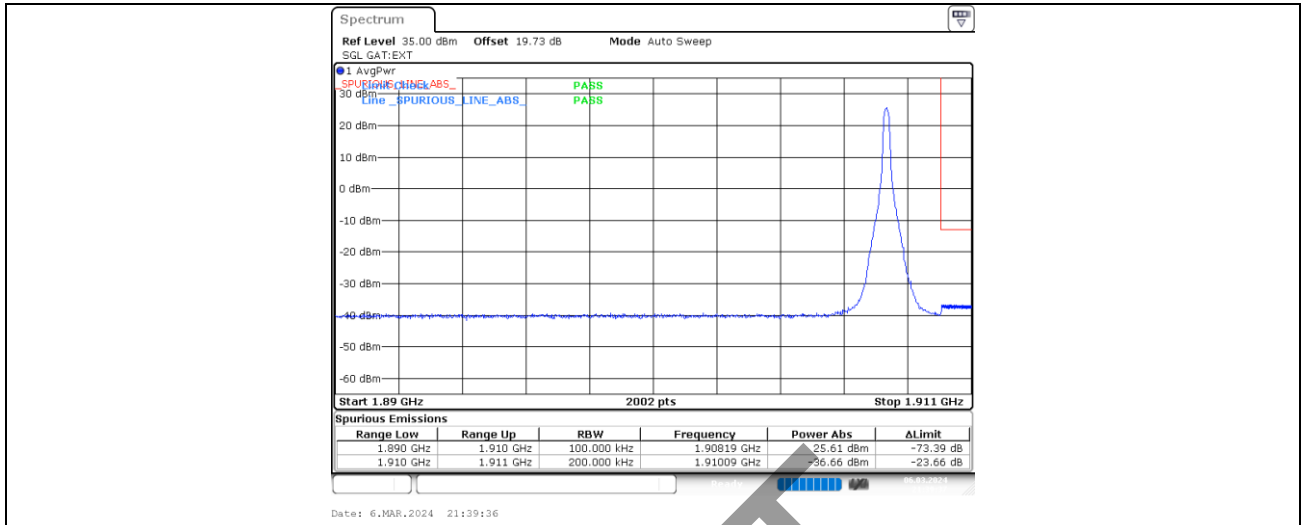

Band2-20MHz-16QAM-19100-1-5-High-1910.09--36.66-23.66-PASS

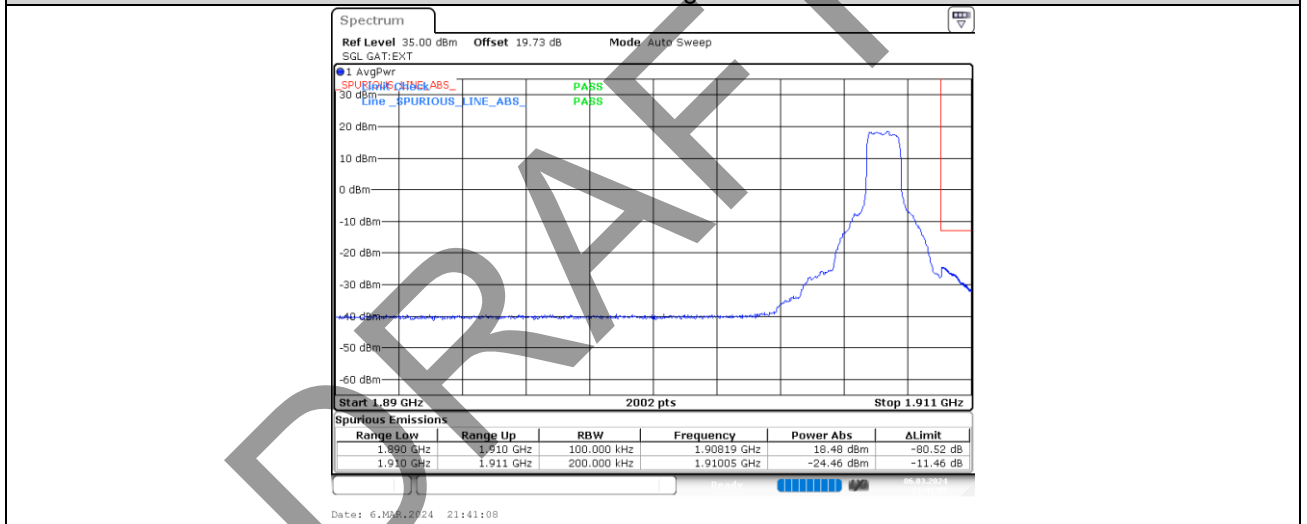

Band2-20MHz-16QAM-19100-6-0-High-1910.05--24.46-11.46-PASS

BV 7Layers Communications Technology (Shenzhen) Co., Ltd

Room B37, Warehouse A5, No.3 Chiwan 4th Road, Zhaoshang Street, Nanshan District Shenzhen, Guangdong, People's Republic of China

Tel: +86 755 8869 6566
Fax: +86 755 8869 6577
Email: customerservice.sw@bureauveritas.com



BUREAU VERITAS

Test Report No.: W7L-P23120015R102

BAND 25 TEST GRAPHS

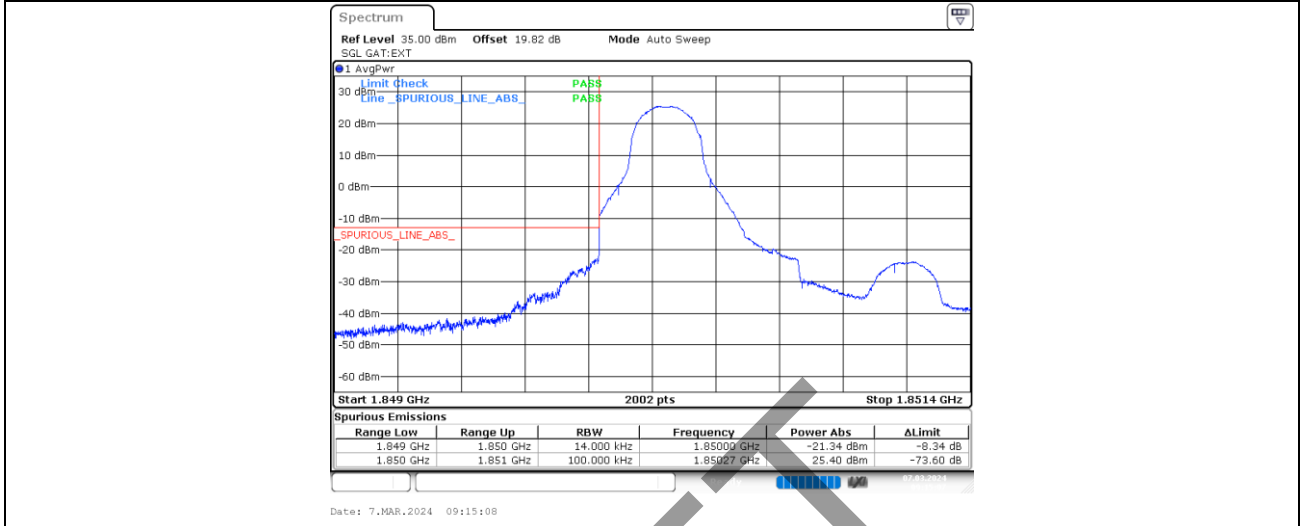

Band25-1.4MHz-QPSK-26047-1-0-Low-1850.00--21.34-8.34-PASS

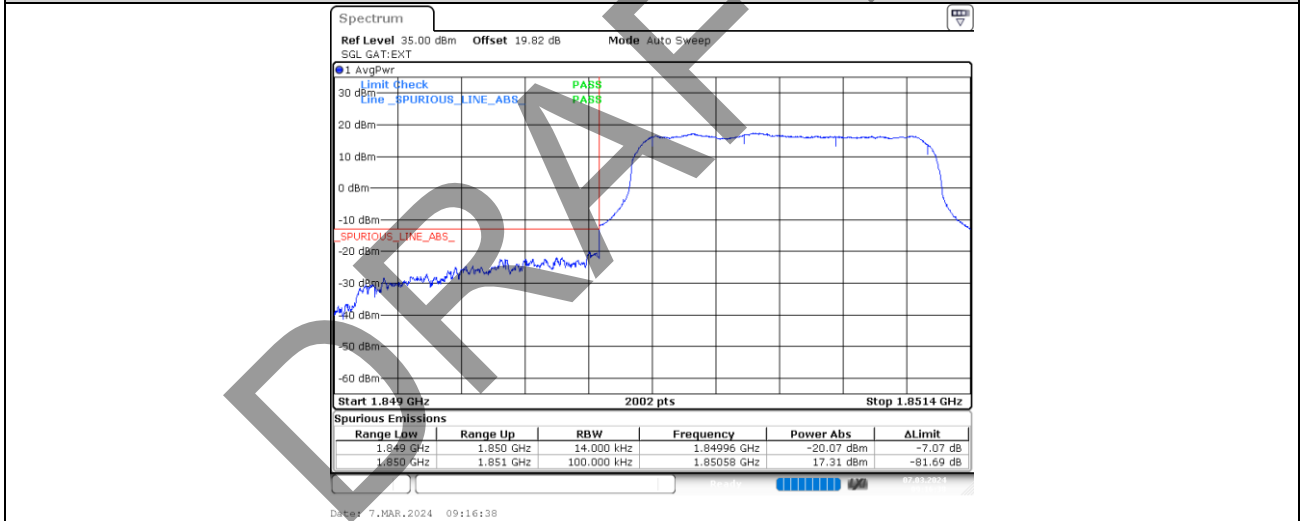

Band25-1.4MHz-QPSK-26047-6-0-Low-1849.96--20.07-7.07-PASS



BUREAU VERITAS

Test Report No.: W7L-P23120015R102

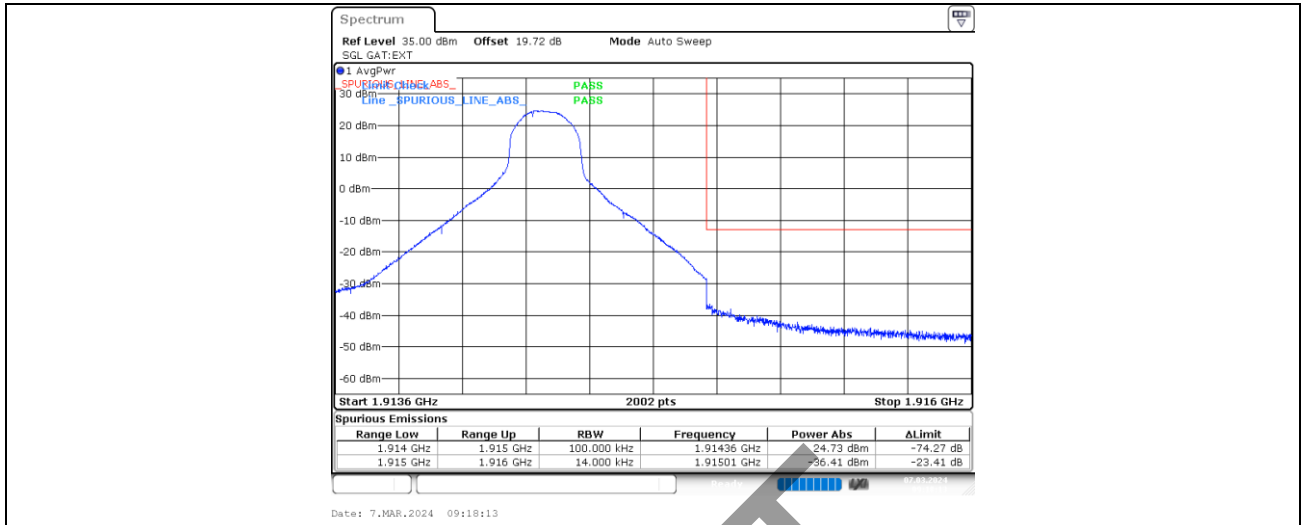

Band25-1.4MHz-QPSK-26683-1-5-High-1915.01--36.41-23.41-PASS

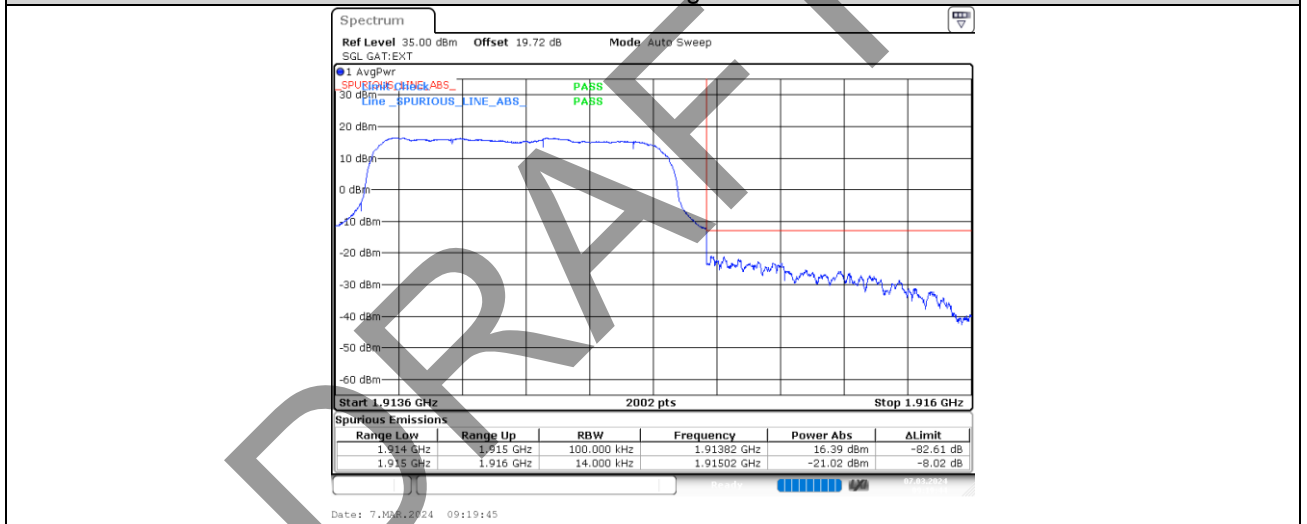

Band25-1.4MHz-QPSK-26683-6-0-High-1915.02--21.02-8.02-PASS

BV 7Layers Communications Technology (Shenzhen) Co., Ltd

Room B37, Warehouse A5, No.3 Chiwan 4th Road, Zhaoshang Street, Nanshan District Shenzhen, Guangdong, People's Republic of China

Tel: +86 755 8869 6566

Fax: +86 755 8869 6577

Email: customerservice.sw@bureauveritas.com



BUREAU VERITAS

Test Report No.: W7L-P23120015R102

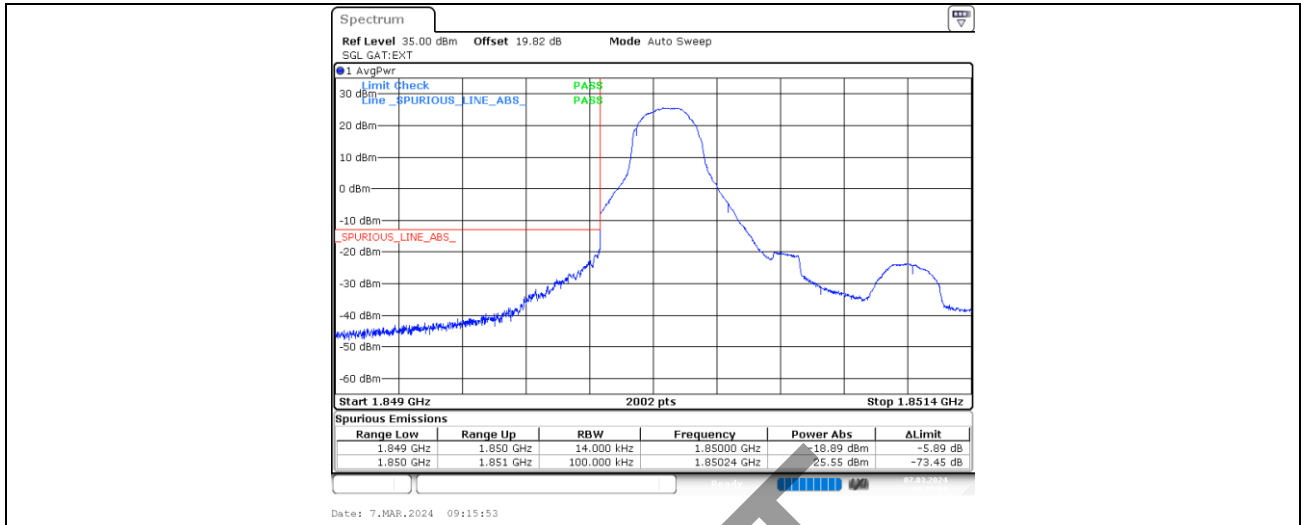

Band25-1.4MHz-16QAM-26047-1-0-Low-1850.00--18.89-5.89-PASS

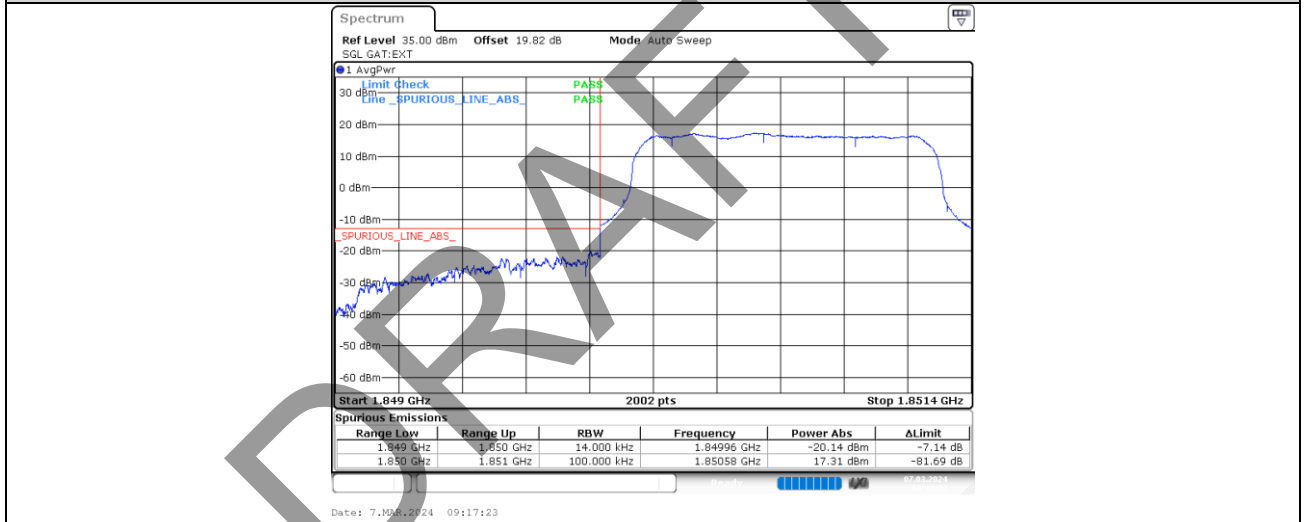

Band25-1.4MHz-16QAM-26047-6-0-Low-1849.96--20.14-7.14-PASS

BV 7Layers Communications Technology (Shenzhen) Co., Ltd

Room B37, Warehouse A5, No.3 Chiwan 4th Road, Zhaoshang Street, Nanshan District Shenzhen, Guangdong, People's Republic of China

Tel: +86 755 8869 6566
Fax: +86 755 8869 6577
Email: customerservice.sw@bureauveritas.com



BUREAU VERITAS

Test Report No.: W7L-P23120015R102

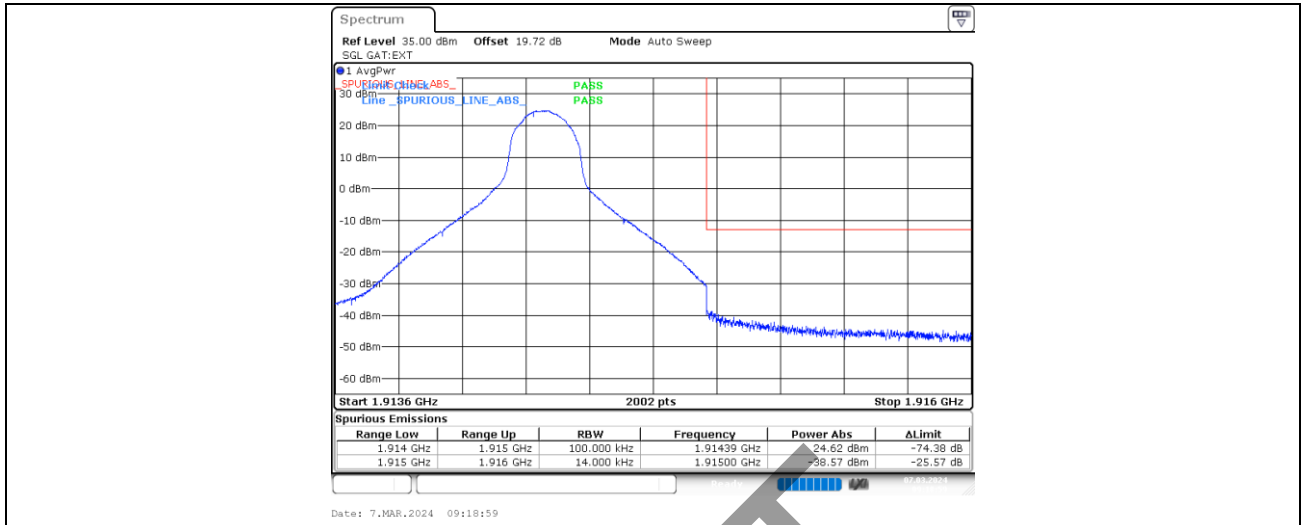

Band25-1.4MHz-16QAM-26683-1-5-High-1915.00--38.57-25.57-PASS

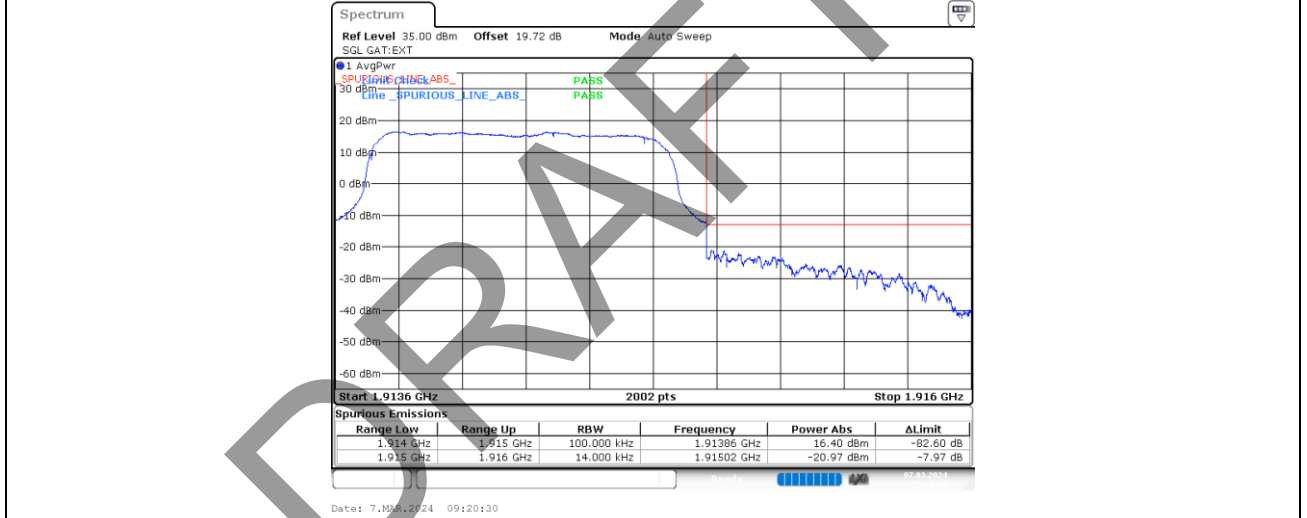

Band25-1.4MHz-16QAM-26683-6-0-High-1915.02--20.97-7.97-PASS

BV 7Layers Communications Technology (Shenzhen) Co., Ltd

Room B37, Warehouse A5, No.3 Chiwan 4th Road, Zhaoshang Street, Nanshan District Shenzhen, Guangdong, People's Republic of China

Tel: +86 755 8869 6566 Fax: +86 755 8869 6577 Email: customerservice.sw@bureauveritas.com



BUREAU VERITAS

Test Report No.: W7L-P23120015R102

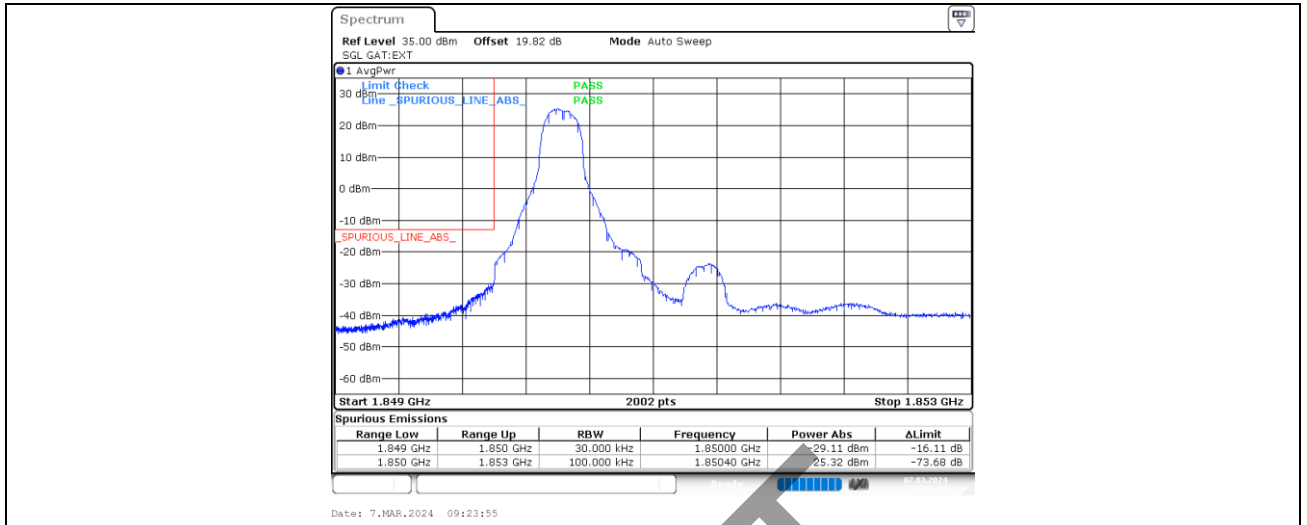

Band25-3MHz-QPSK-26055-1-0-Low-1850.00--29.11-16.11-PASS

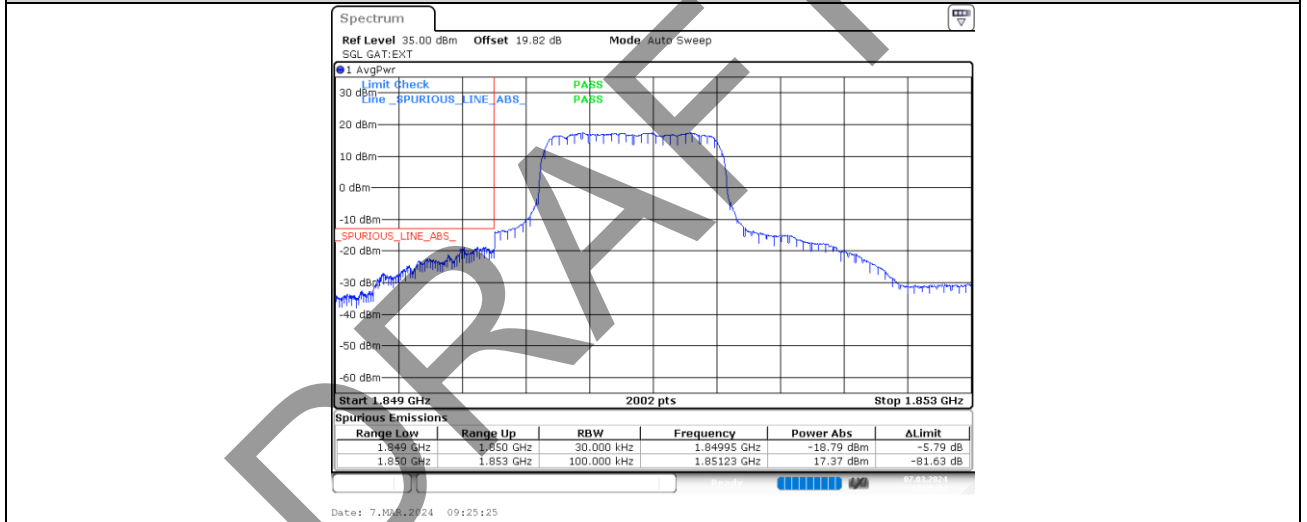

Band25-3MHz-QPSK-26055-6-0-Low-1849.95--18.79-5.79-PASS



BUREAU VERITAS

Test Report No.: W7L-P23120015R102

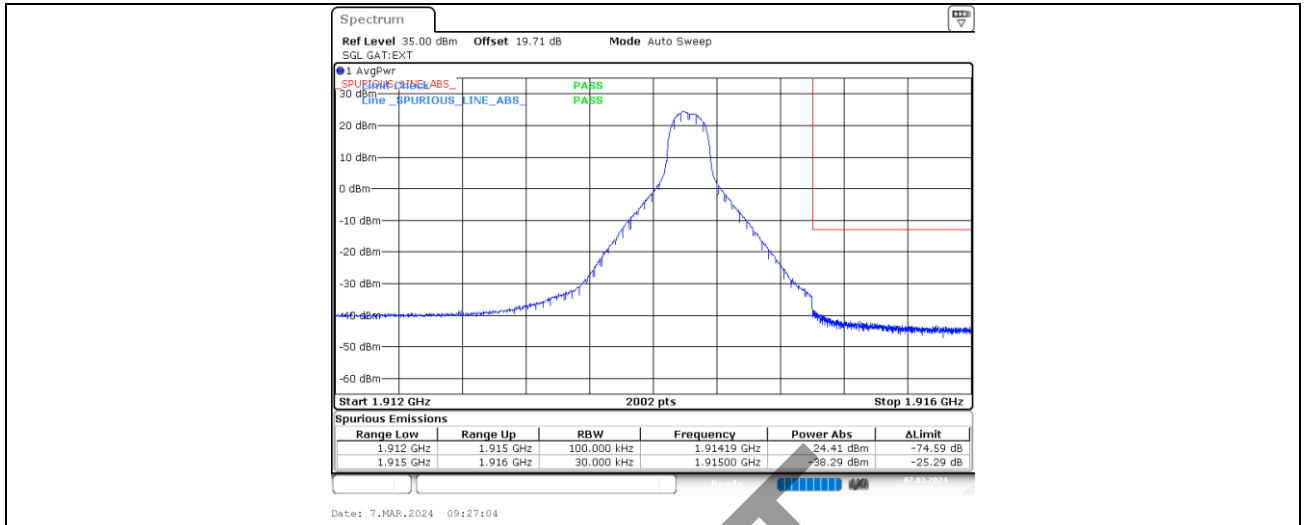

Band25-3MHz-QPSK-26675-1-5-High-1915.00--38.29-25.29-PASS

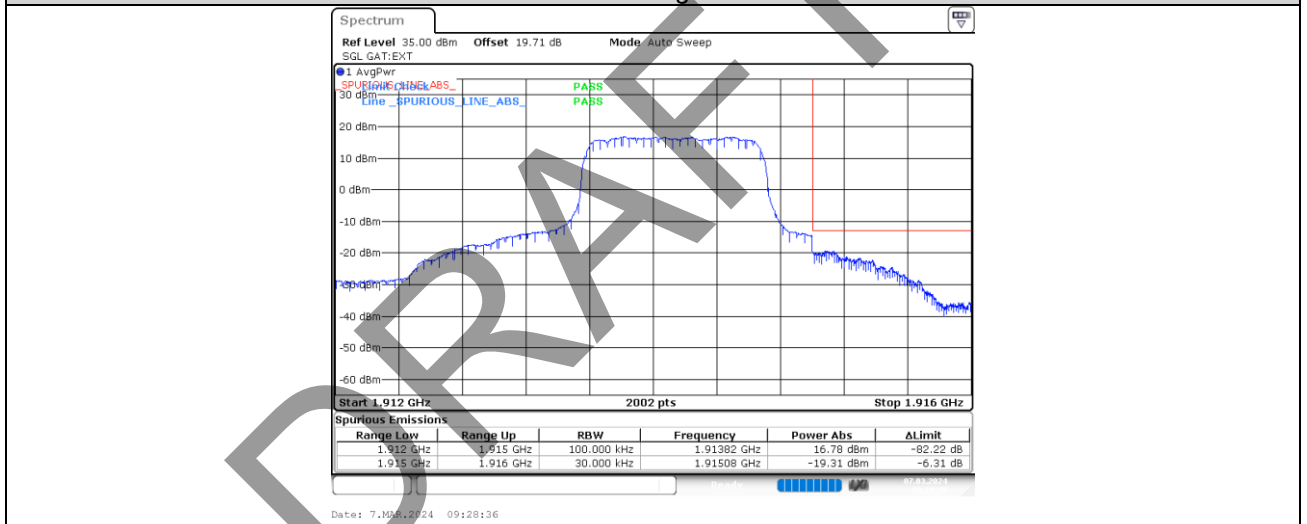

Band25-3MHz-QPSK-26675-6-0-High-1915.08--19.31-6.31-PASS

BV 7Layers Communications Technology (Shenzhen) Co., Ltd

Room B37, Warehouse A5, No.3 Chiwan 4th Road, Zhaoshang Street, Nanshan District Shenzhen, Guangdong, People's Republic of China

Tel: +86 755 8869 6566 Fax: +86 755 8869 6577

Email: customerservice.sw@bureauveritas.com



BUREAU VERITAS

Test Report No.: W7L-P23120015R102

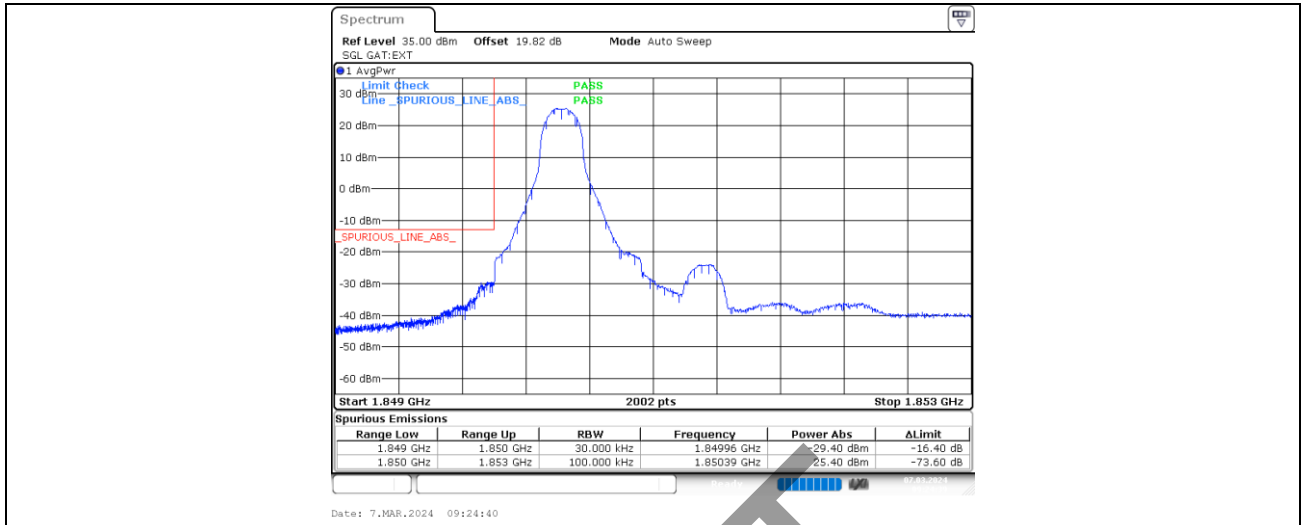

Band25-3MHz-16QAM-26055-1-0-Low-1849.96--29.40-16.40-PASS

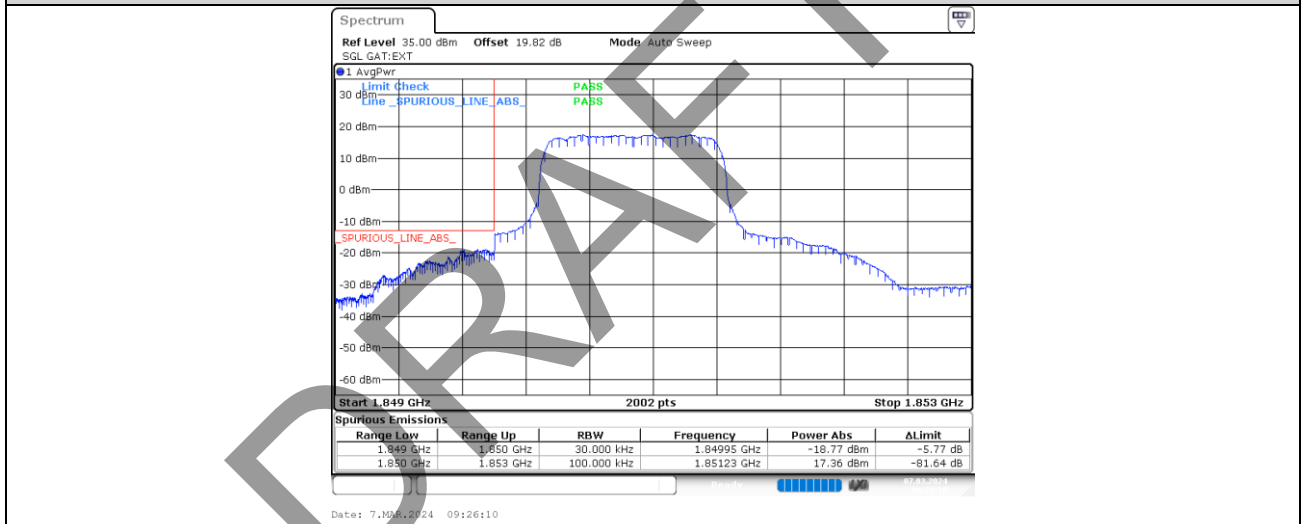

Band25-3MHz-16QAM-26055-6-0-Low-1849.95--18.77-5.77-PASS

BV 7Layers Communications Technology (Shenzhen) Co., Ltd

Room B37, Warehouse A5, No.3 Chiwan 4th Road, Zhaoshang Street, Nanshan District Shenzhen, Guangdong, People's Republic of China

Tel: +86 755 8869 6566 Fax: +86 755 8869 6577

Email: customerservice.sw@bureauveritas.com



BUREAU VERITAS

Test Report No.: W7L-P23120015R102

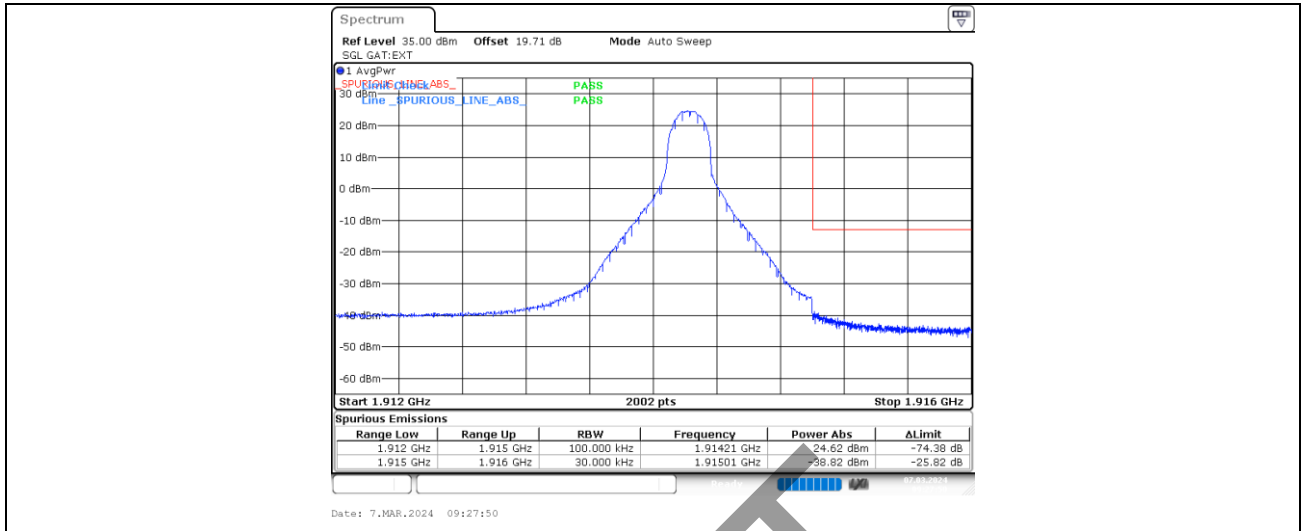

Band25-3MHz-16QAM-26675-1-5-High-1915.01--38.82-25.82-PASS

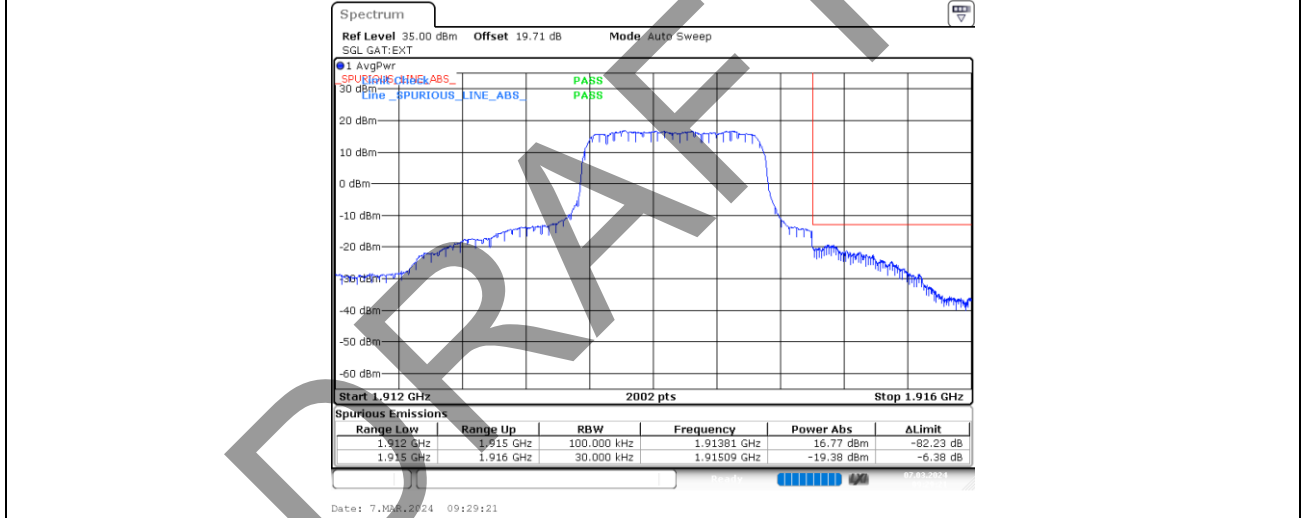

Band25-3MHz-16QAM-26675-6-0-High-1915.09--19.38-6.38-PASS

BV 7Layers Communications Technology (Shenzhen) Co., Ltd

Room B37, Warehouse A5, No.3 Chiwan 4th Road, Zhaoshang Street, Nanshan District Shenzhen, Guangdong, People's Republic of China

Tel: +86 755 8869 6566 Fax: +86 755 8869 6577 Email: customerservice.sw@bureauveritas.com



BUREAU VERITAS

Test Report No.: W7L-P23120015R102

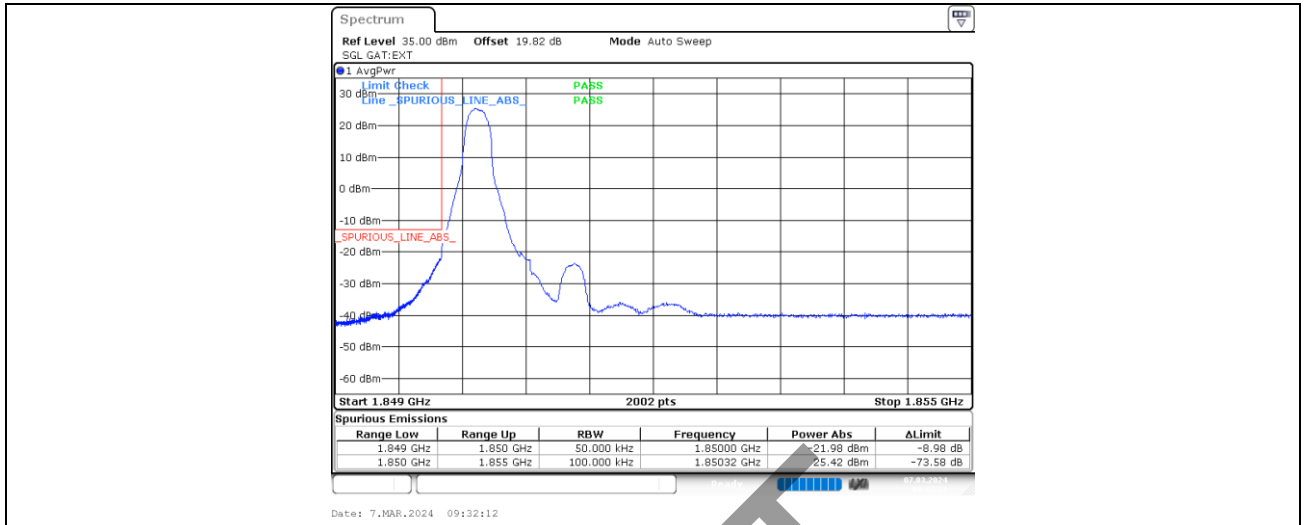

Band25-5MHz-QPSK-26065-1-0-Low-1850.00--21.98-8.98-PASS

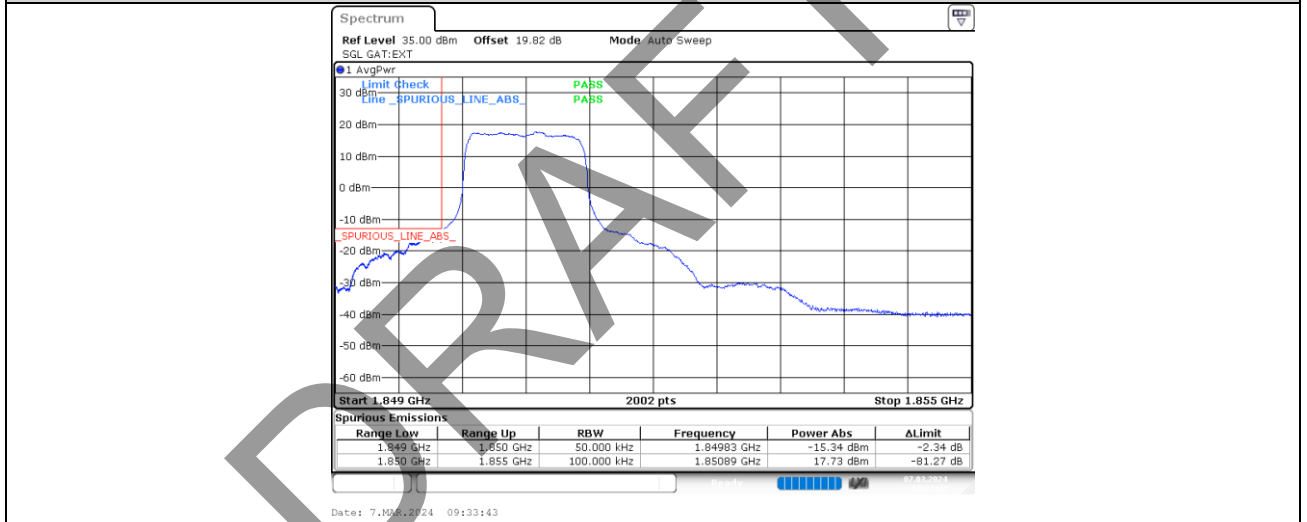

Band25-5MHz-QPSK-26065-6-0-Low-1849.83--15.34-2.34-PASS

BV 7Layers Communications Technology (Shenzhen) Co., Ltd

Room B37, Warehouse A5, No.3 Chiwan 4th Road, Zhaoshang Street, Nanshan District Shenzhen, Guangdong, People's Republic of China

Tel: +86 755 8869 6566 Fax: +86 755 8869 6577 Email: customerservice.sw@bureauveritas.com



BUREAU VERITAS

Test Report No.: W7L-P23120015R102

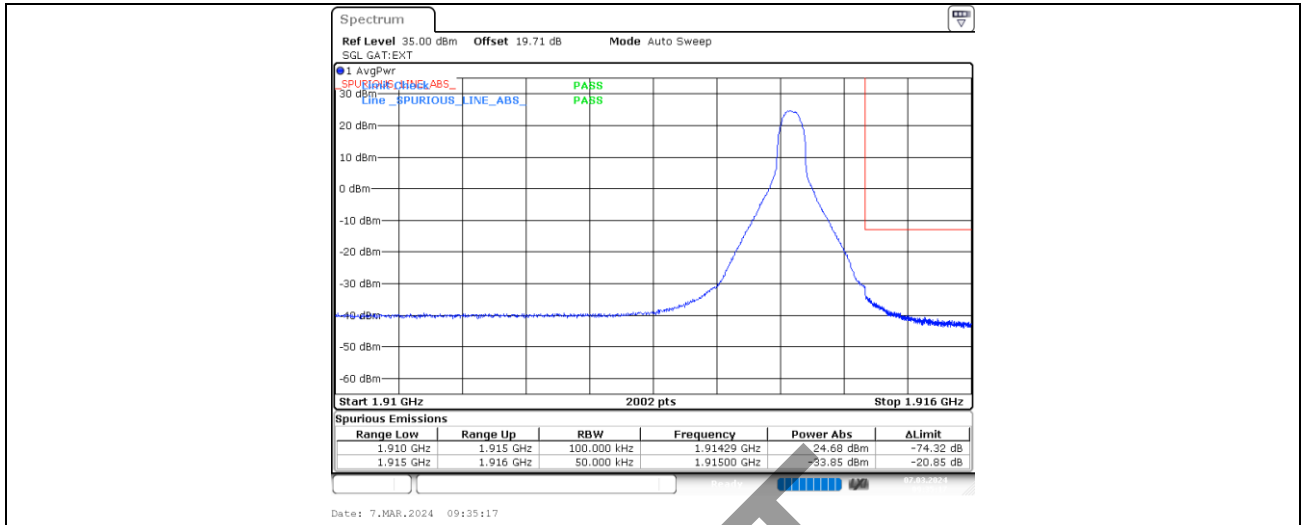

Band25-5MHz-QPSK-26665-1-5-High-1915.00--33.85-20.85-PASS

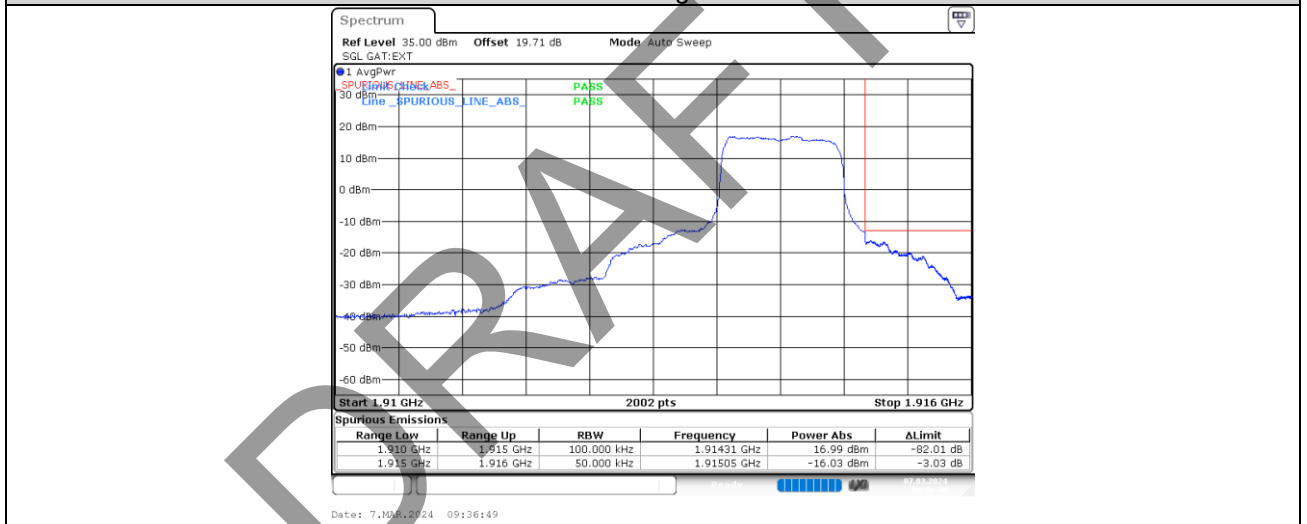

Band25-5MHz-QPSK-26665-6-0-High-1915.05--16.03-3.03-PASS

BV 7Layers Communications Technology (Shenzhen) Co., Ltd

Room B37, Warehouse A5, No.3 Chiwan 4th Road, Zhaoshang Street, Nanshan District Shenzhen, Guangdong, People's Republic of China

Tel: +86 755 8869 6566 Fax: +86 755 8869 6577 Email: customerservice.sw@bureauveritas.com



BUREAU VERITAS

Test Report No.: W7L-P23120015R102

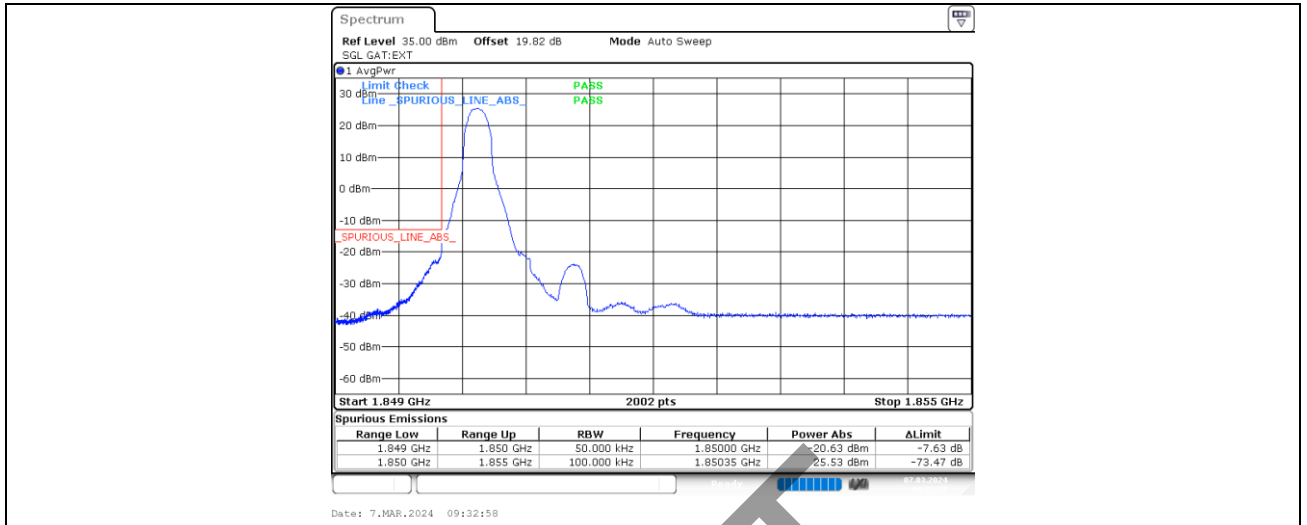

Band25-5MHz-16QAM-26065-1-0-Low-1850.00--20.63-7.63-PASS

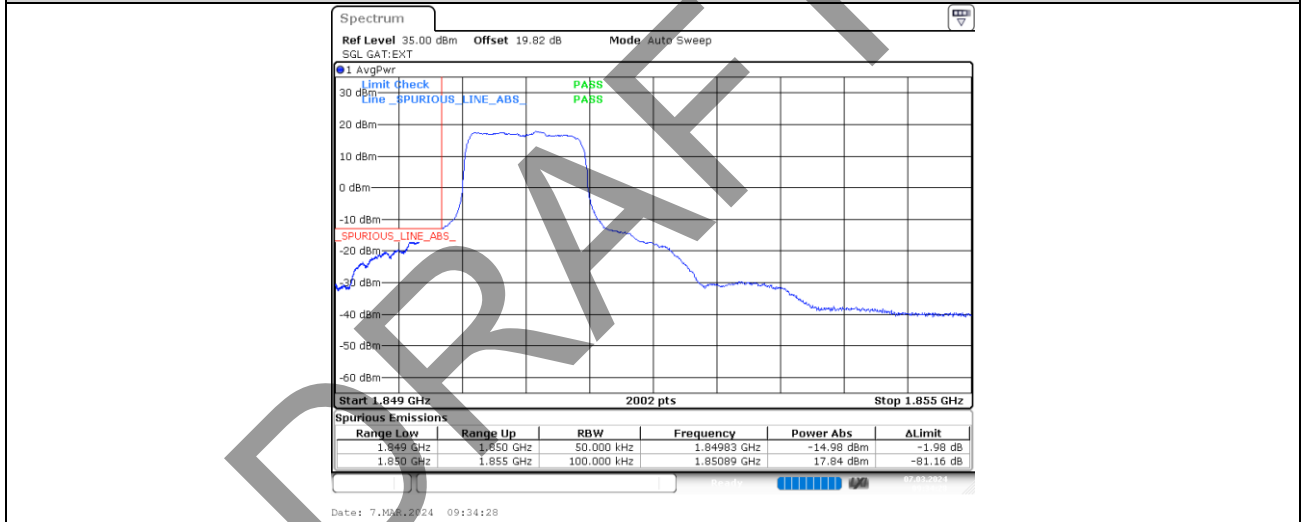

Band25-5MHz-16QAM-26065-6-0-Low-1849.83--14.98-1.98-PASS

BV 7Layers Communications Technology (Shenzhen) Co., Ltd

Room B37, Warehouse A5, No.3 Chiwan 4th Road, Zhaoshang Street, Nanshan District Shenzhen, Guangdong, People's Republic of China

Tel: +86 755 8869 6566
Fax: +86 755 8869 6577
Email: customerservice.sw@bureauveritas.com



BUREAU VERITAS

Test Report No.: W7L-P23120015R102

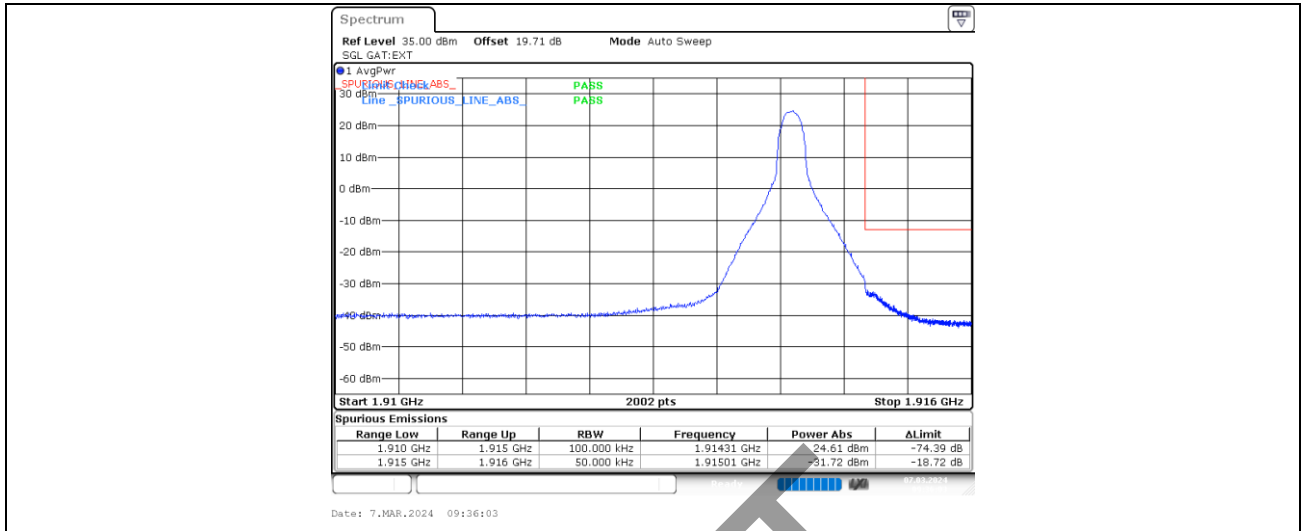

Band25-5MHz-16QAM-26665-1-5-High-1915.01--31.72-18.72-PASS

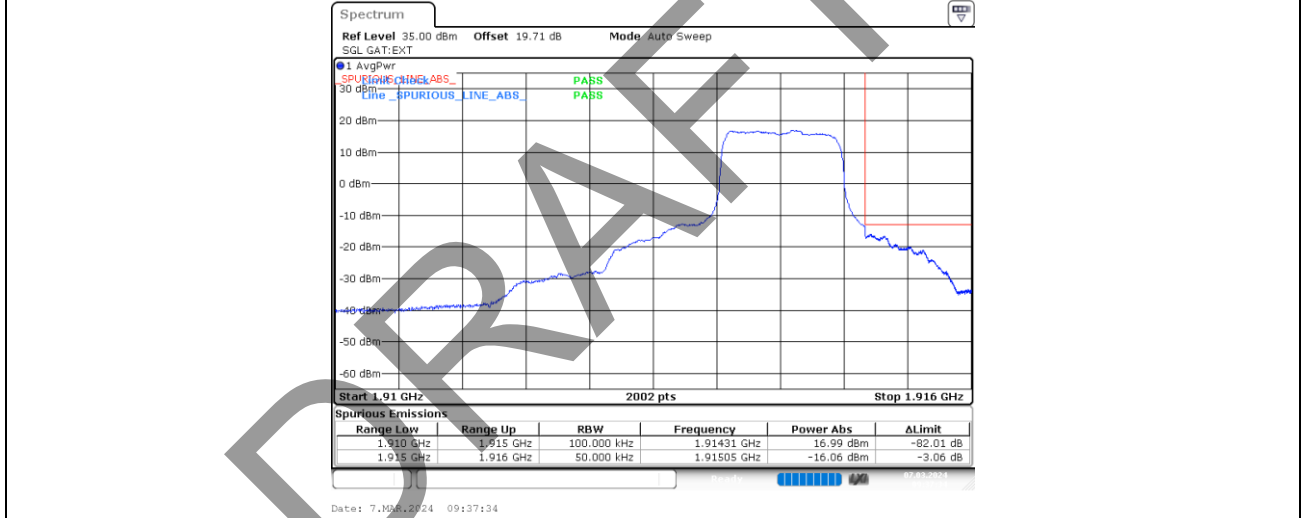

Band25-5MHz-16QAM-26665-6-0-High-1915.05--16.06-3.06-PASS

BV 7Layers Communications Technology (Shenzhen) Co., Ltd

Room B37, Warehouse A5, No.3 Chiwan 4th Road, Zhaoshang Street, Nanshan District Shenzhen, Guangdong, People's Republic of China

Tel: +86 755 8869 6566
Fax: +86 755 8869 6577
Email: customerservice.sw@bureauveritas.com



BUREAU VERITAS

Test Report No.: W7L-P23120015R102

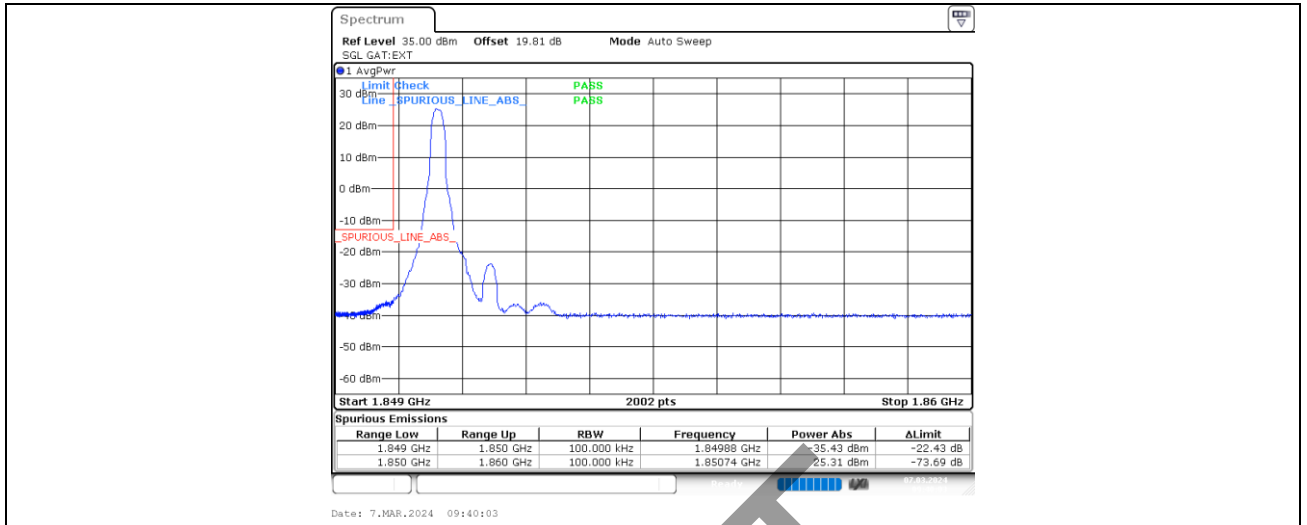

Band25-10MHz-QPSK-26090-1-0-Low-1849.88--35.43-22.43-PASS

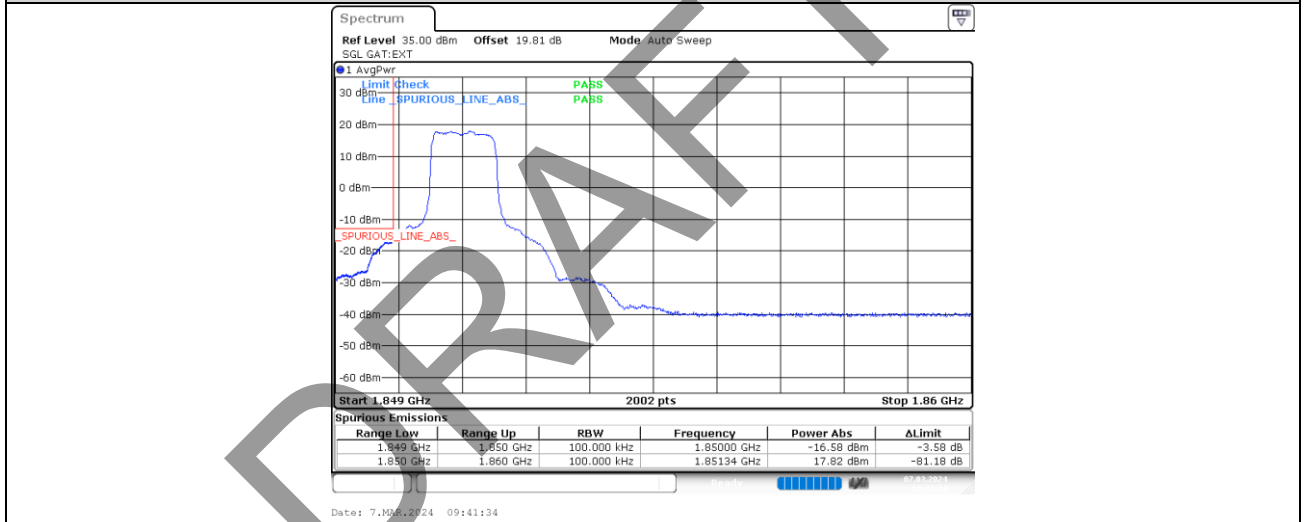

Band25-10MHz-QPSK-26090-6-0-Low-1850.00--16.58-3.58-PASS



BUREAU VERITAS

Test Report No.: W7L-P23120015R102

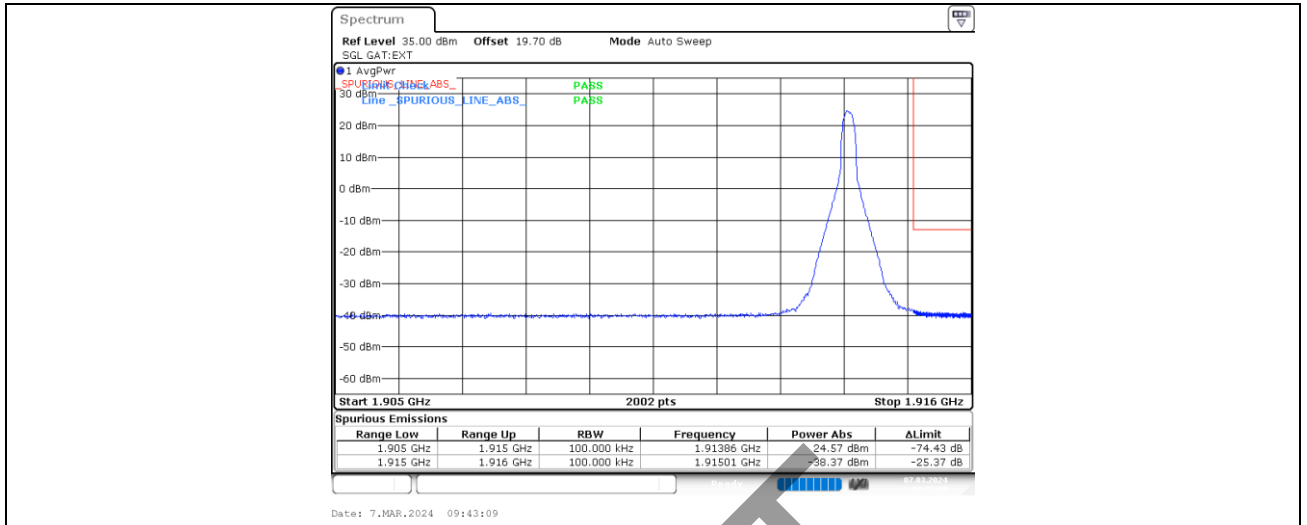

Band25-10MHz-QPSK-26640-1-5-High-1915.01--38.37-25.37-PASS

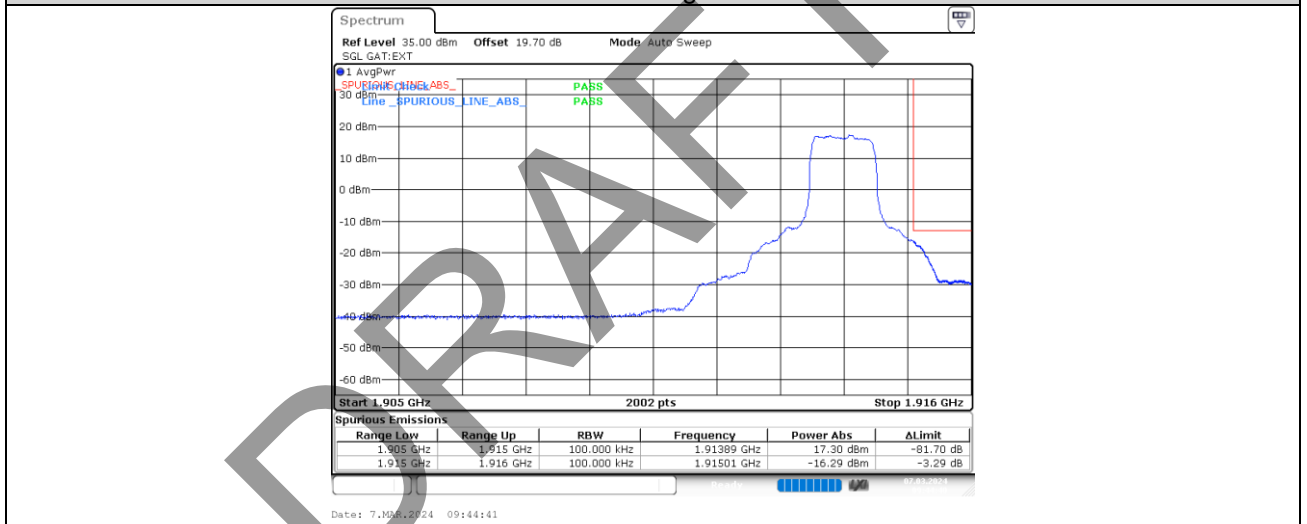

Band25-10MHz-QPSK-26640-6-0-High-1915.01--16.29-3.29-PASS

BV 7Layers Communications Technology (Shenzhen) Co., Ltd

Room B37, Warehouse A5, No.3 Chiwan 4th Road, Zhaoshang Street, Nanshan District Shenzhen, Guangdong, People's Republic of China

Tel: +86 755 8869 6566
Fax: +86 755 8869 6577
Email: customerservice.sw@bureauveritas.com



BUREAU VERITAS

Test Report No.: W7L-P23120015R102

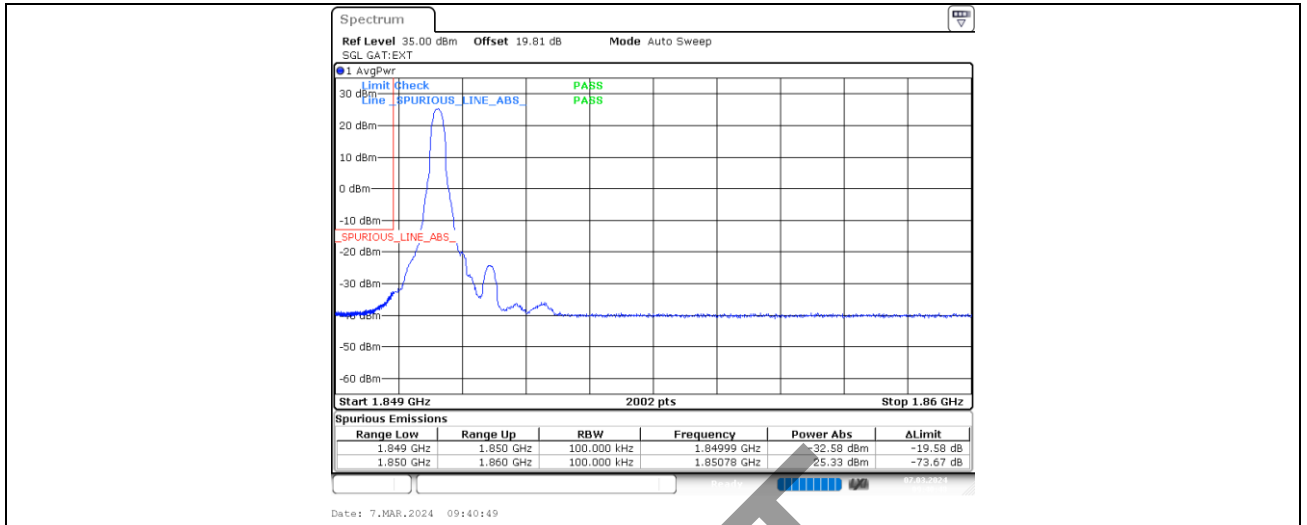

Band25-10MHz-16QAM-26090-1-0-Low-1849.99--32.58-19.58-PASS

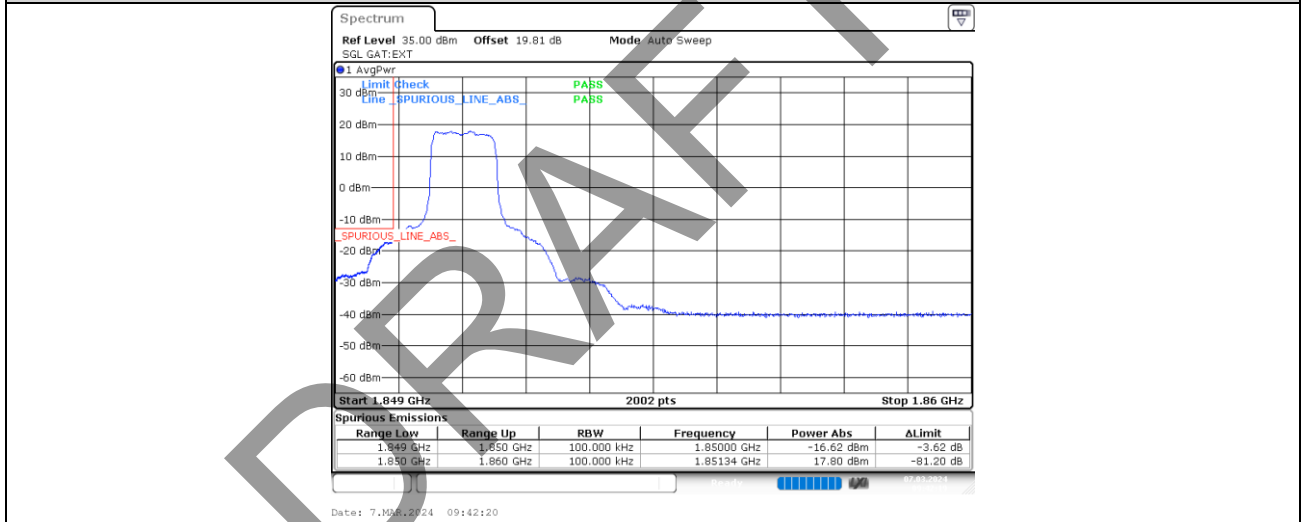

Band25-10MHz-16QAM-26090-6-0-Low-1850.00--16.62-3.62-PASS

BV 7Layers Communications Technology (Shenzhen) Co., Ltd

Room B37, Warehouse A5, No.3 Chiwan 4th Road, Zhaoshang Street, Nanshan District Shenzhen, Guangdong, People's Republic of China

Tel: +86 755 8869 6566
Fax: +86 755 8869 6577
Email: customerservice.sw@bureauveritas.com



BUREAU VERITAS

Test Report No.: W7L-P23120015R102

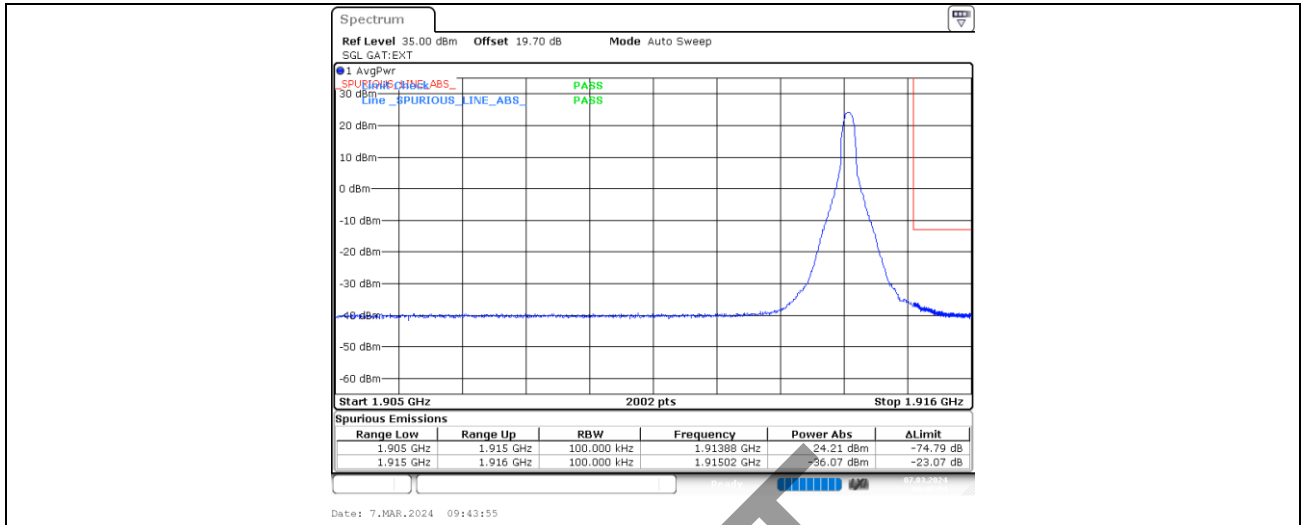

Band25-10MHz-16QAM-26640-1-5-High-1915.02--36.07-23.07-PASS

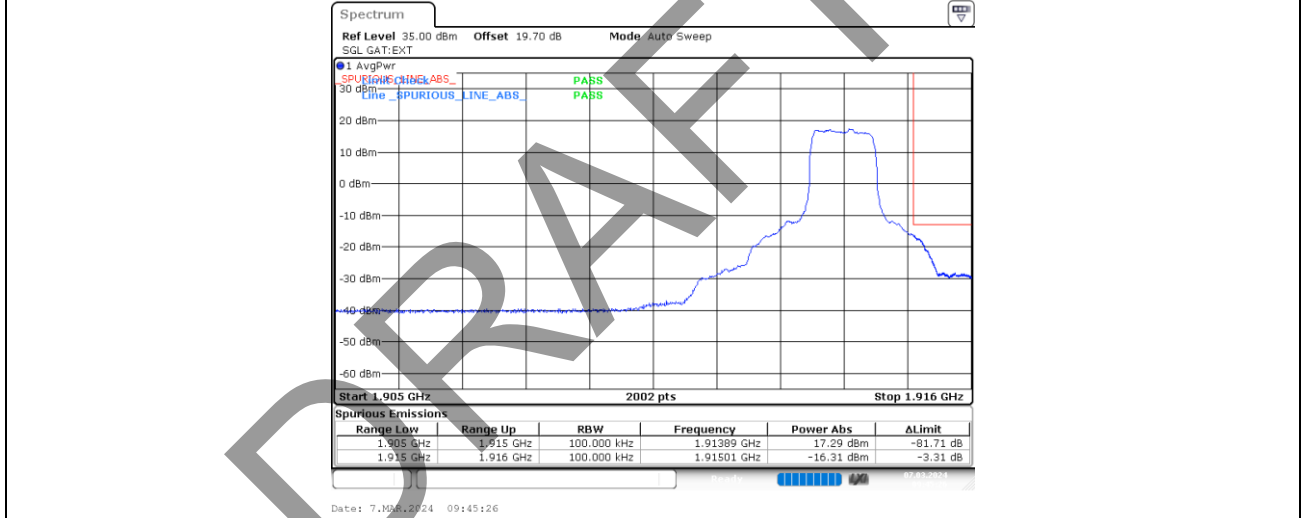

Band25-10MHz-16QAM-26640-6-0-High-1915.01--16.31-3.31-PASS

BV 7Layers Communications Technology (Shenzhen) Co., Ltd

Room B37, Warehouse A5, No.3 Chiwan 4th Road, Zhaoshang Street, Nanshan District Shenzhen, Guangdong, People's Republic of China

Tel: +86 755 8869 6566
Fax: +86 755 8869 6577
Email: customerservice.sw@bureauveritas.com



BUREAU VERITAS

Test Report No.: W7L-P23120015R102

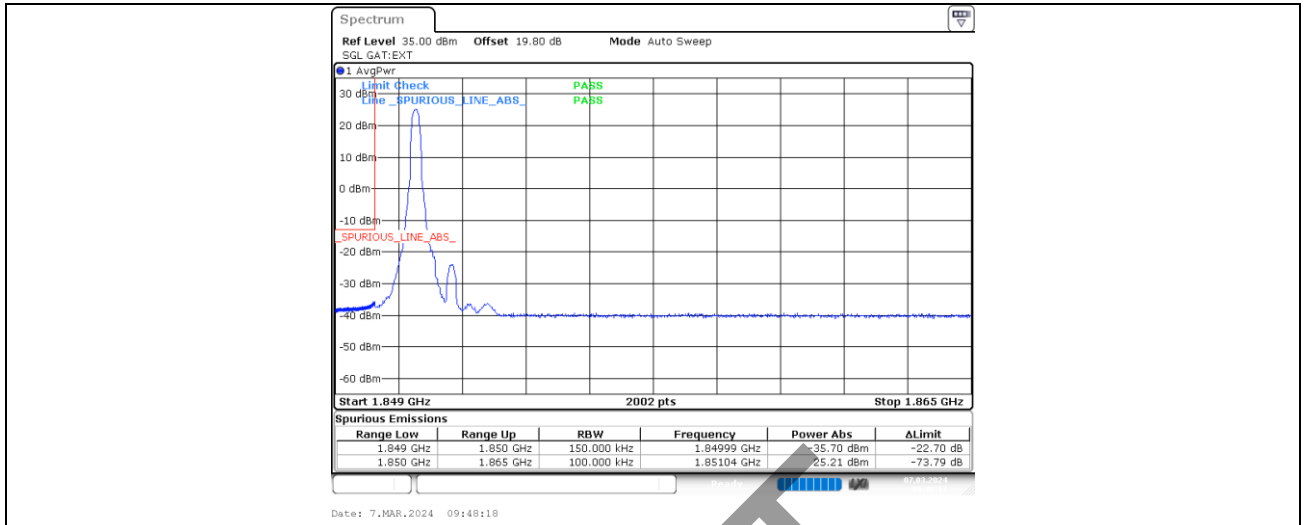

Band25-15MHz-QPSK-26115-1-0-Low-1849.99--35.70-22.70-PASS

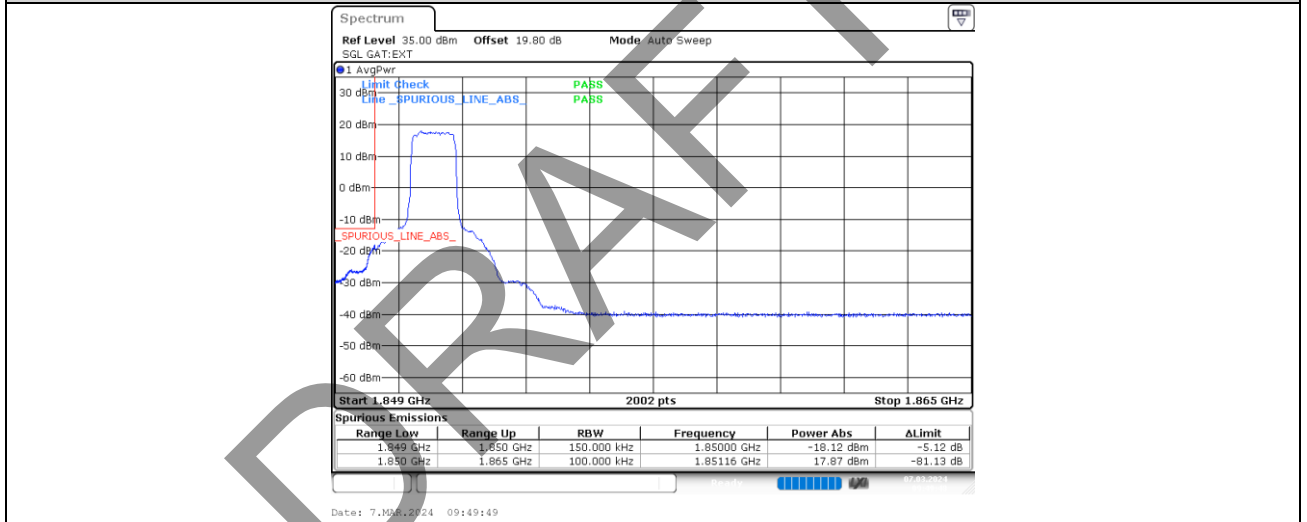

Band25-15MHz-QPSK-26115-6-0-Low-1850.00--18.12-5.12-PASS



BUREAU VERITAS

Test Report No.: W7L-P23120015R102

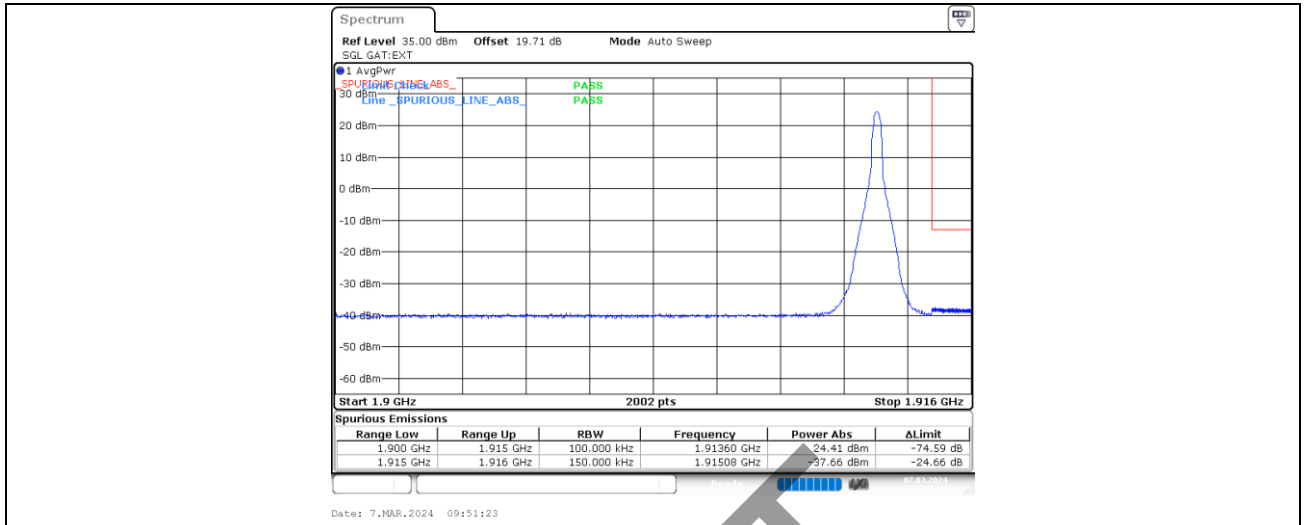

Band25-15MHz-QPSK-26615-1-5-High-1915.08--37.66-24.66-PASS

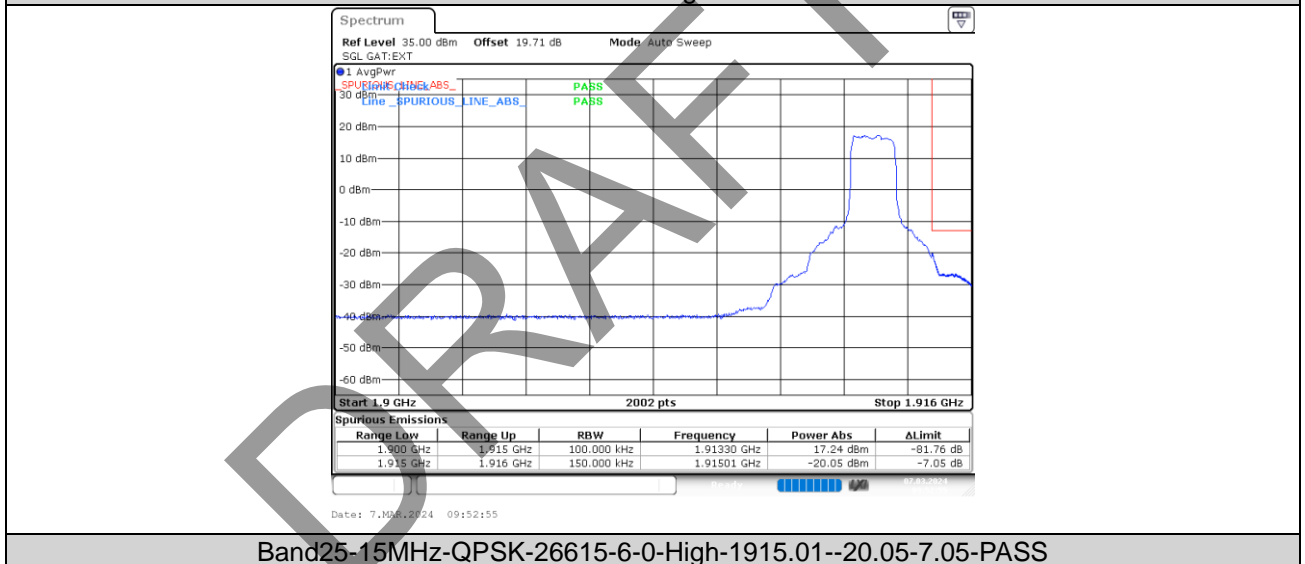

Band25-15MHz-QPSK-26615-6-0-High-1915.01--20.05-7.05-PASS

BV 7Layers Communications Technology (Shenzhen) Co., Ltd

Room B37, Warehouse A5, No.3 Chiwan 4th Road, Zhaoshang Street, Nanshan District Shenzhen, Guangdong, People's Republic of China

Tel: +86 755 8869 6566 Fax: +86 755 8869 6577 Email: customerservice.sw@bureauveritas.com



BUREAU VERITAS

Test Report No.: W7L-P23120015R102

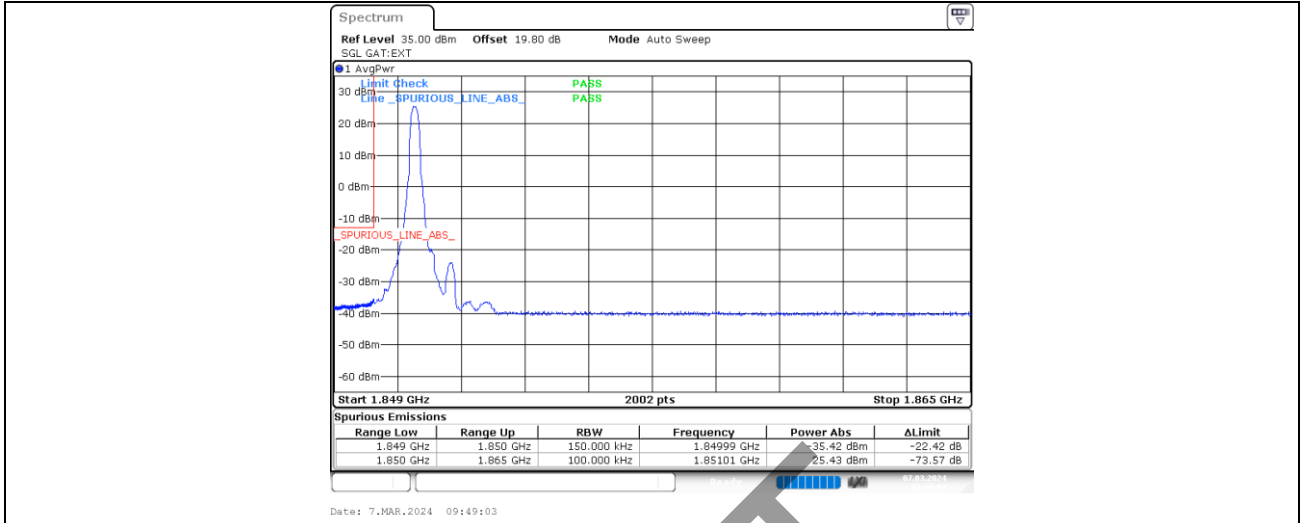

Band25-15MHz-16QAM-26115-1-0-Low-1849.99--35.42-22.42-PASS

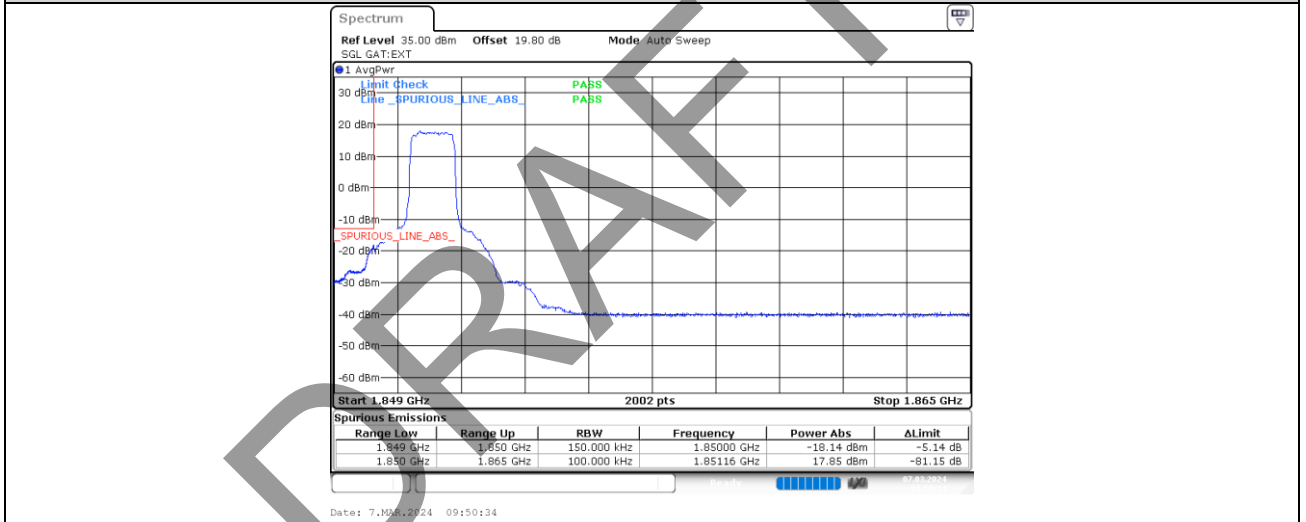

Band25-15MHz-16QAM-26115-6-0-Low-1850.00--18.14-5.14-PASS

BV 7Layers Communications Technology (Shenzhen) Co., Ltd

Room B37, Warehouse A5, No.3 Chiwan 4th Road, Zhaoshang Street, Nanshan District Shenzhen, Guangdong, People's Republic of China

Tel: +86 755 8869 6566

Fax: +86 755 8869 6577

Email: customerservice.sw@bureauveritas.com



BUREAU VERITAS

Test Report No.: W7L-P23120015R102

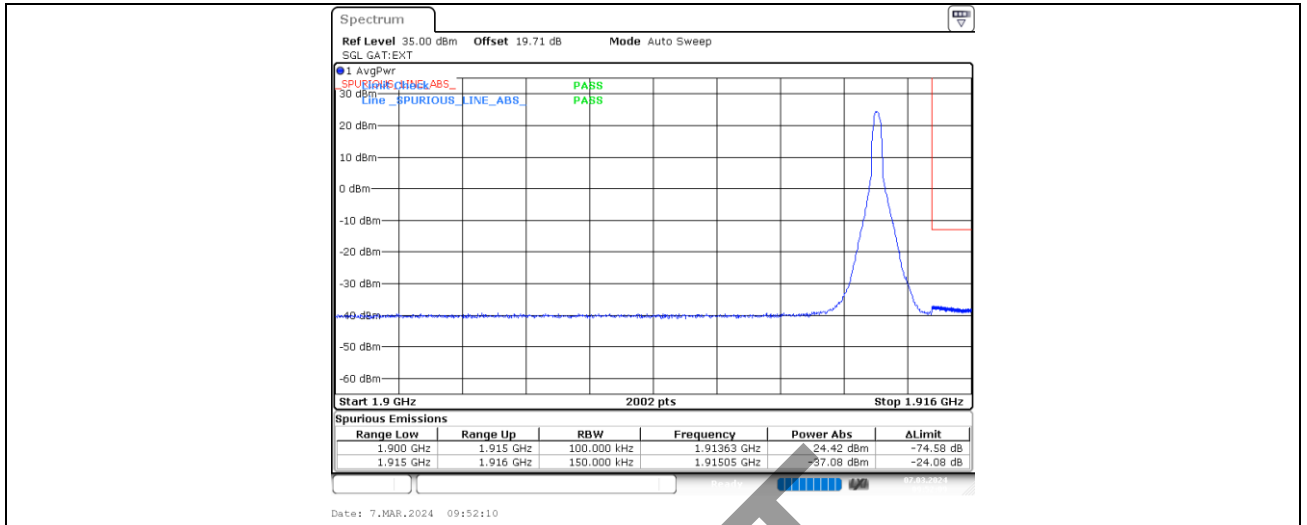

Band25-15MHz-16QAM-26615-1-5-High-1915.05--37.08-24.08-PASS

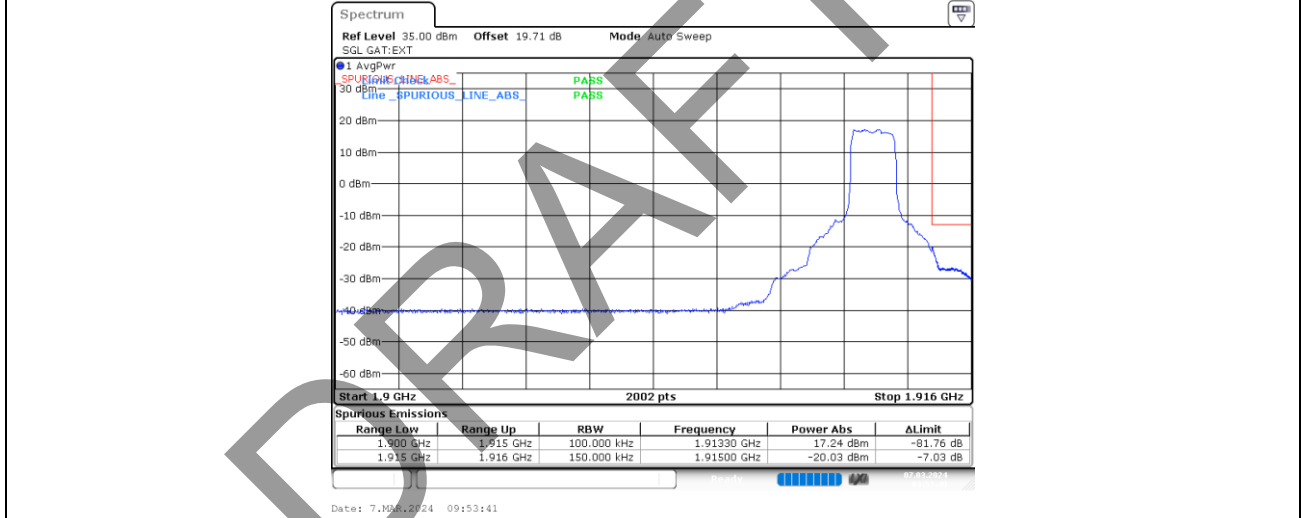

Band25-15MHz-16QAM-26615-6-0-High-1915.00--20.03-7.03-PASS

BV 7Layers Communications Technology (Shenzhen) Co., Ltd

Room B37, Warehouse A5, No.3 Chiwan 4th Road, Zhaoshang Street, Nanshan District Shenzhen, Guangdong, People's Republic of China

Tel: +86 755 8869 6566 Fax: +86 755 8869 6577 Email: customerservice.sw@bureauveritas.com



BUREAU VERITAS

Test Report No.: W7L-P23120015R102

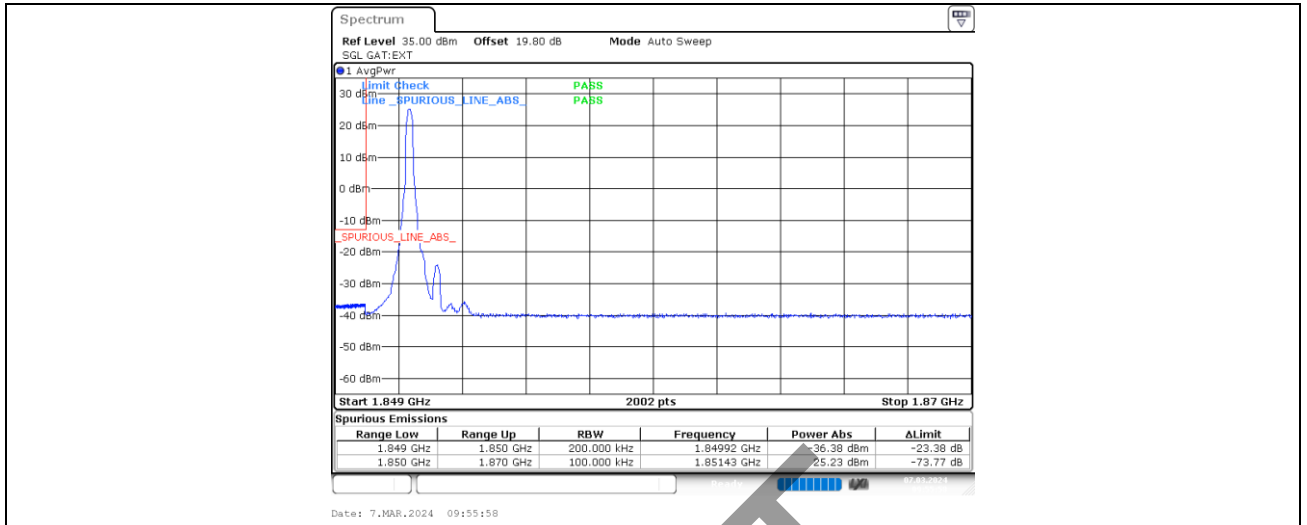

Band25-20MHz-QPSK-26140-1-0-Low-1849.92--36.38-23.38-PASS

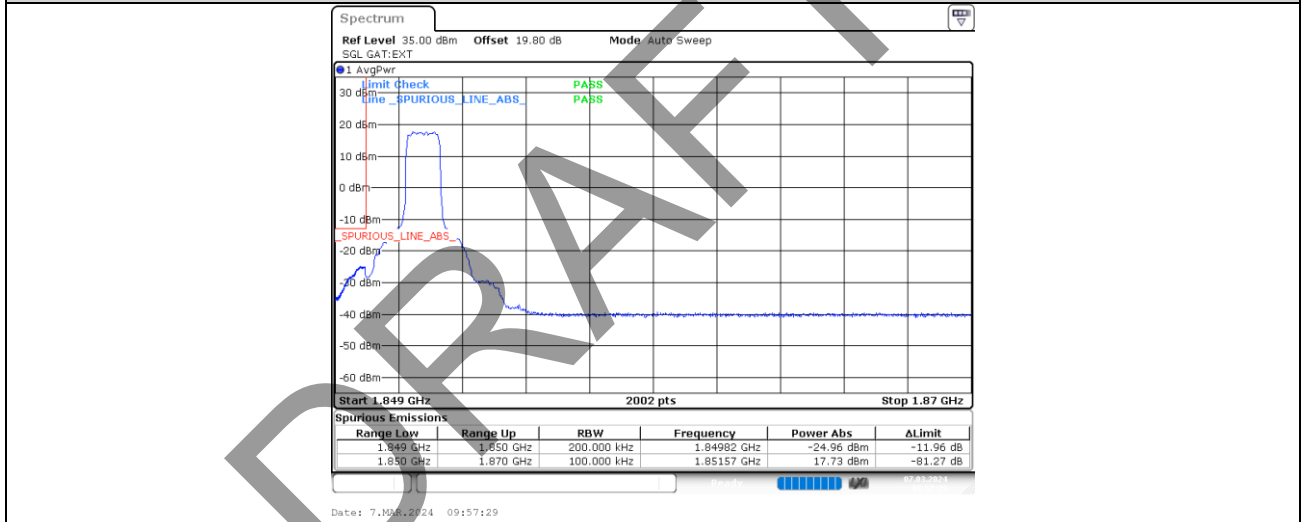

Band25-20MHz-QPSK-26140-6-0-Low-1849.82--24.96-11.96-PASS

BV 7Layers Communications Technology (Shenzhen) Co., Ltd

Room B37, Warehouse A5, No.3 Chiwan 4th Road, Zhaoshang Street, Nanshan District Shenzhen, Guangdong, People's Republic of China

Tel: +86 755 8869 6566
Fax: +86 755 8869 6577
Email: customerservice.sw@bureauveritas.com



BUREAU VERITAS

Test Report No.: W7L-P23120015R102

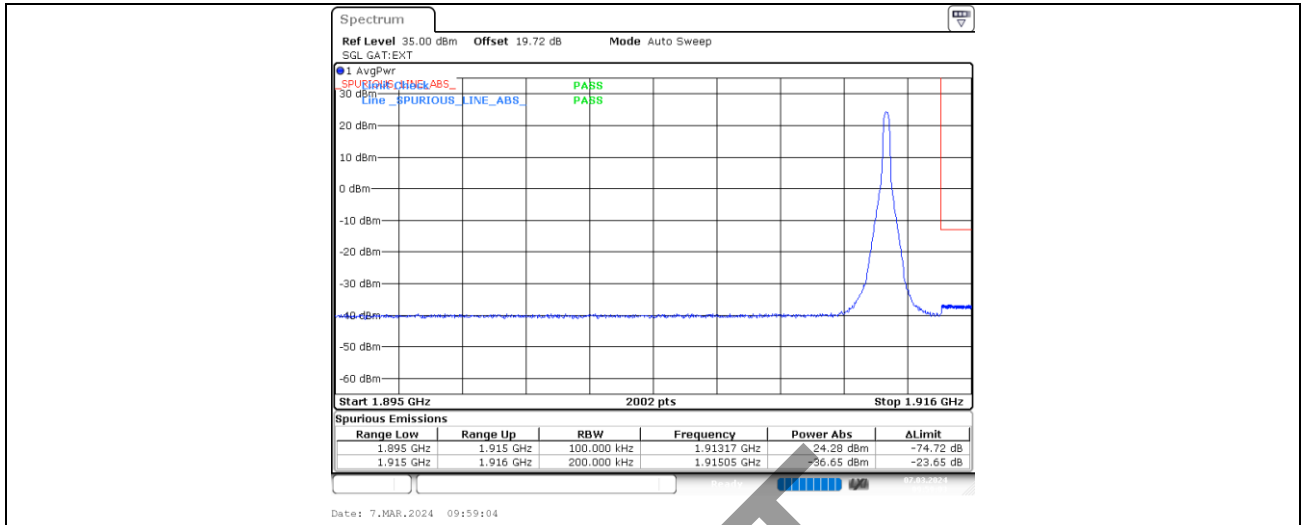

Band25-20MHz-QPSK-26590-1-5-High-1915.05--36.65-23.65-PASS

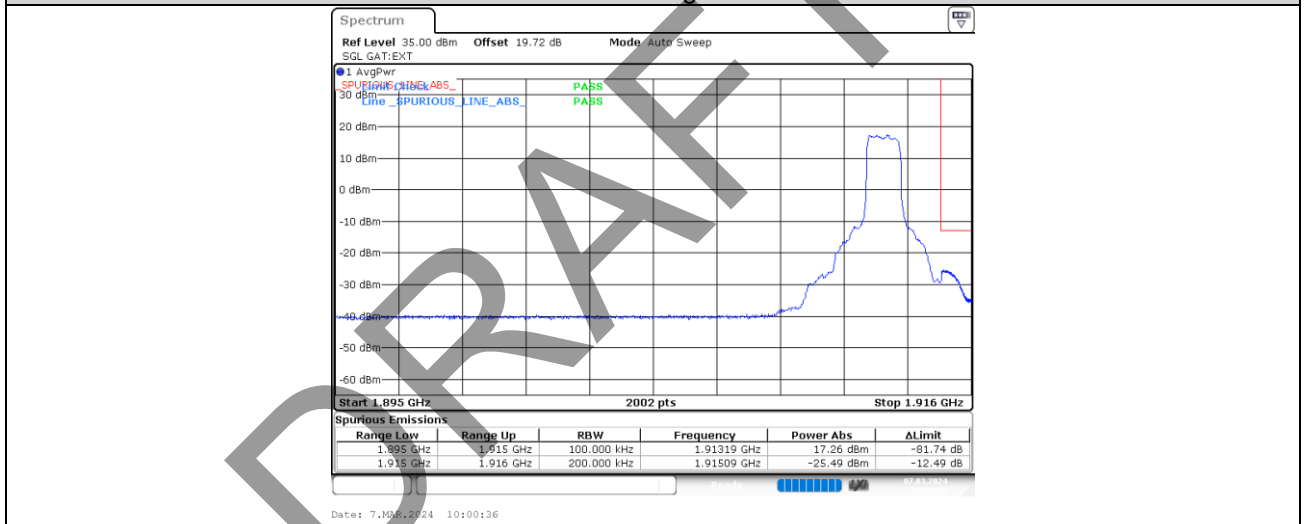

Band25-20MHz-QPSK-26590-6-0-High-1915.09--25.49-12.49-PASS

BV 7Layers Communications Technology (Shenzhen) Co., Ltd

Room B37, Warehouse A5, No.3 Chiwan 4th Road, Zhaoshang Street, Nanshan District Shenzhen, Guangdong, People's Republic of China

Tel: +86 755 8869 6566 Fax: +86 755 8869 6577 Email: customerservice.sw@bureauveritas.com



BUREAU VERITAS

Test Report No.: W7L-P23120015R102

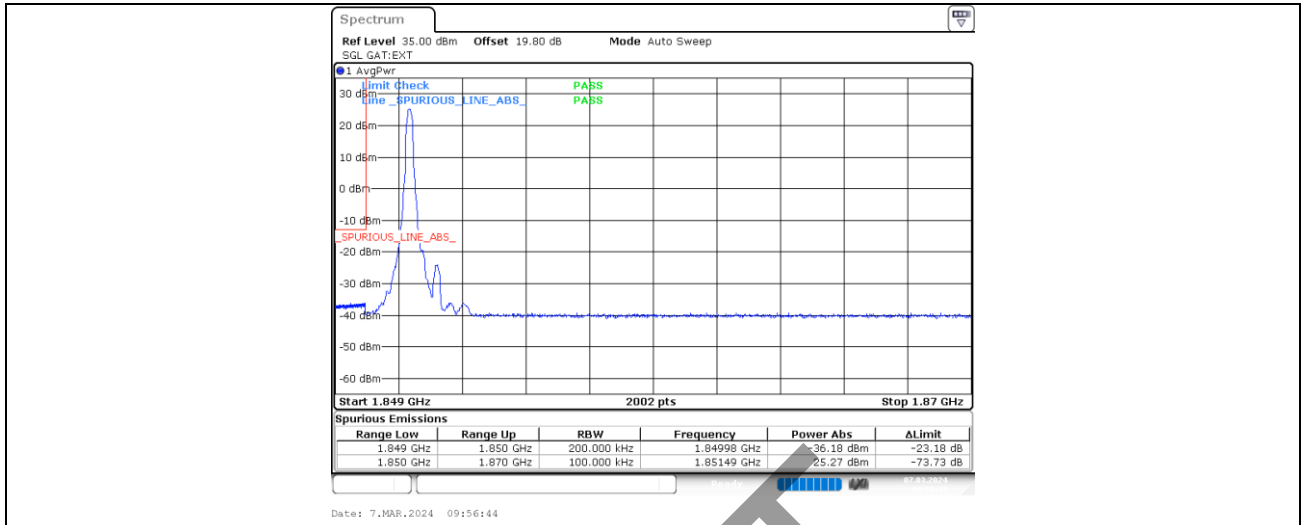

Band25-20MHz-16QAM-26140-1-0-Low-1849.98--36.18-23.18-PASS

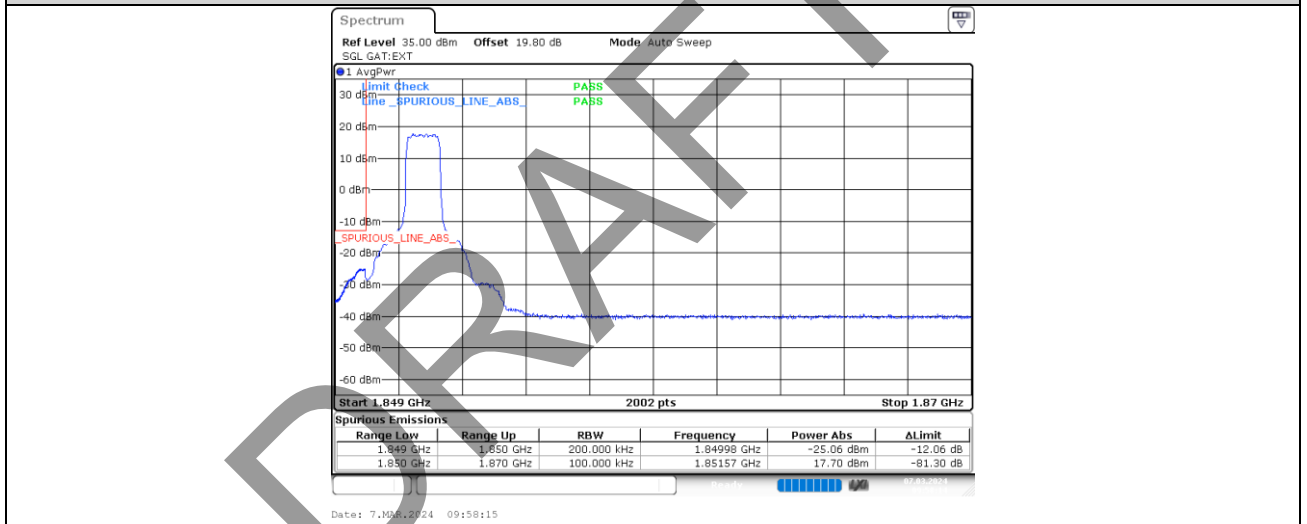

Band25-20MHz-16QAM-26140-6-0-Low-1849.98--25.06-12.06-PASS

BV 7Layers Communications Technology (Shenzhen) Co., Ltd

Room B37, Warehouse A5, No.3 Chiwan 4th Road, Zhaoshang Street, Nanshan District Shenzhen, Guangdong, People's Republic of China

Tel: +86 755 8869 6566
Fax: +86 755 8869 6577
Email: customerservice.sw@bureauveritas.com



BUREAU VERITAS

Test Report No.: W7L-P23120015R102

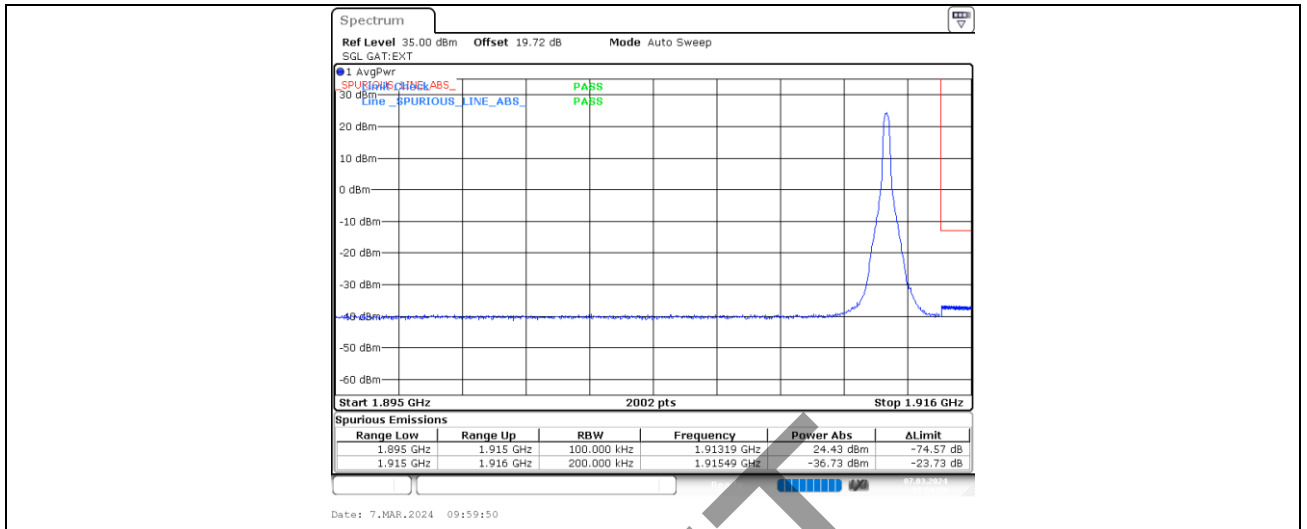

Band25-20MHz-16QAM-26590-1-5-High-1915.49--36.73-23.73-PASS

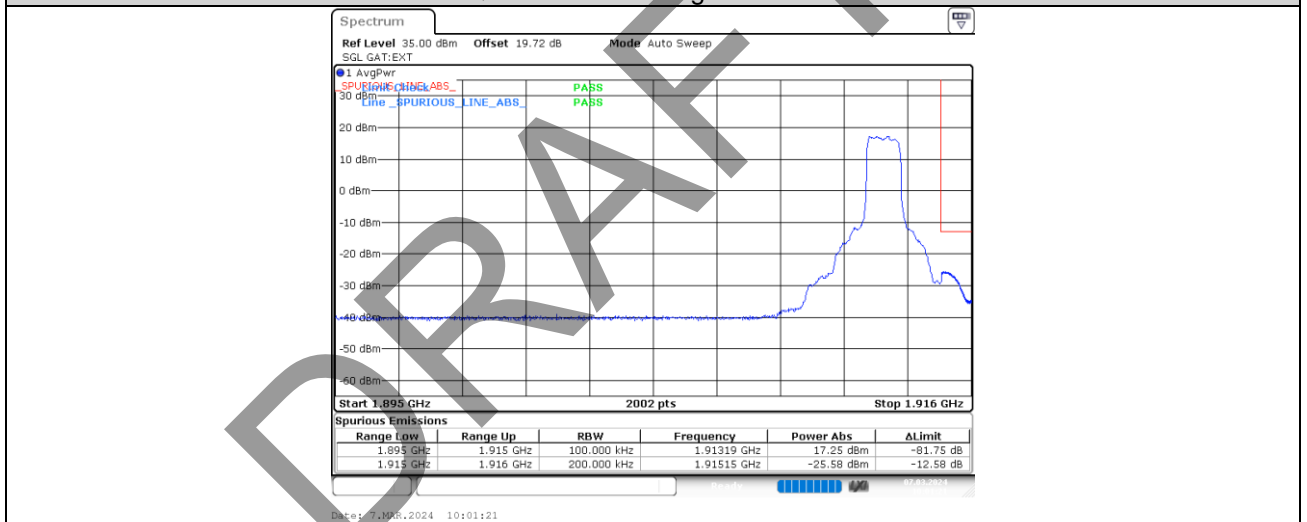

Band25-20MHz-16QAM-26590-6-0-High-1915.15--25.58-12.58-PASS

BV 7Layers Communications Technology (Shenzhen) Co., Ltd

Room B37, Warehouse A5, No.3 Chiwan 4th Road, Zhaoshang Street, Nanshan District Shenzhen, Guangdong, People's Republic of China

Tel: +86 755 8869 6566
Fax: +86 755 8869 6577
Email: customerservice.sw@bureauveritas.com



CONDUCTED SPURIOUS EMISSION FOR M1

GPRS 1900 TEST RESULT

Band	Channel	Frequency Range(MHz)	Max.Freq. (MHz)	Result (dBm)	Limit (dBm)	Verdict
GPRS1900	512	0.009~0.15MHz	0.02	-72.07	-43	PASS
GPRS1900	512	0.15~30MHz	0.16	-52.71	-23	PASS
GPRS1900	512	30~1000MHz	841.75	-35.88	-13	PASS
GPRS1900	512	1000~18000MHz	15573.53	-22.55	-13	PASS
GPRS1900	661	0.009~0.15MHz	0.03	-73.17	-43	PASS
GPRS1900	661	0.15~30MHz	0.16	-53.12	-23	PASS
GPRS1900	661	30~1000MHz	890.93	-36.22	-13	PASS
GPRS1900	661	1000~18000MHz	15886.9	-23.02	-13	PASS
GPRS1900	810	0.009~0.15MHz	0.01	-70.73	-43	PASS
GPRS1900	810	0.15~30MHz	0.38	-53.95	-23	PASS
GPRS1900	810	30~1000MHz	856.78	-36.04	-13	PASS
GPRS1900	810	1000~18000MHz	15544.07	-23.11	-13	PASS
EGPRS1900	512	0.009~0.15MHz	0.02	-59.94	-43	PASS
EGPRS1900	512	0.15~30MHz	0.2	-54.13	-23	PASS
EGPRS1900	512	30~1000MHz	917.05	-36.62	-13	PASS
EGPRS1900	512	1000~18000MHz	15569	-23.12	-13	PASS
EGPRS1900	661	0.009~0.15MHz	0.03	-62.93	-43	PASS
EGPRS1900	661	0.15~30MHz	0.34	-52.91	-23	PASS
EGPRS1900	661	30~1000MHz	850.06	-35.97	-13	PASS
EGPRS1900	661	1000~18000MHz	15559.93	-23.23	-13	PASS
EGPRS1900	810	0.009~0.15MHz	0.03	-62.7	-43	PASS
EGPRS1900	810	0.15~30MHz	0.21	-53.76	-23	PASS
EGPRS1900	810	30~1000MHz	988.44	-36.06	-13	PASS
EGPRS1900	810	1000~18000MHz	15516.87	-23.36	-13	PASS

GPRS 1900 TEST GRAPHS

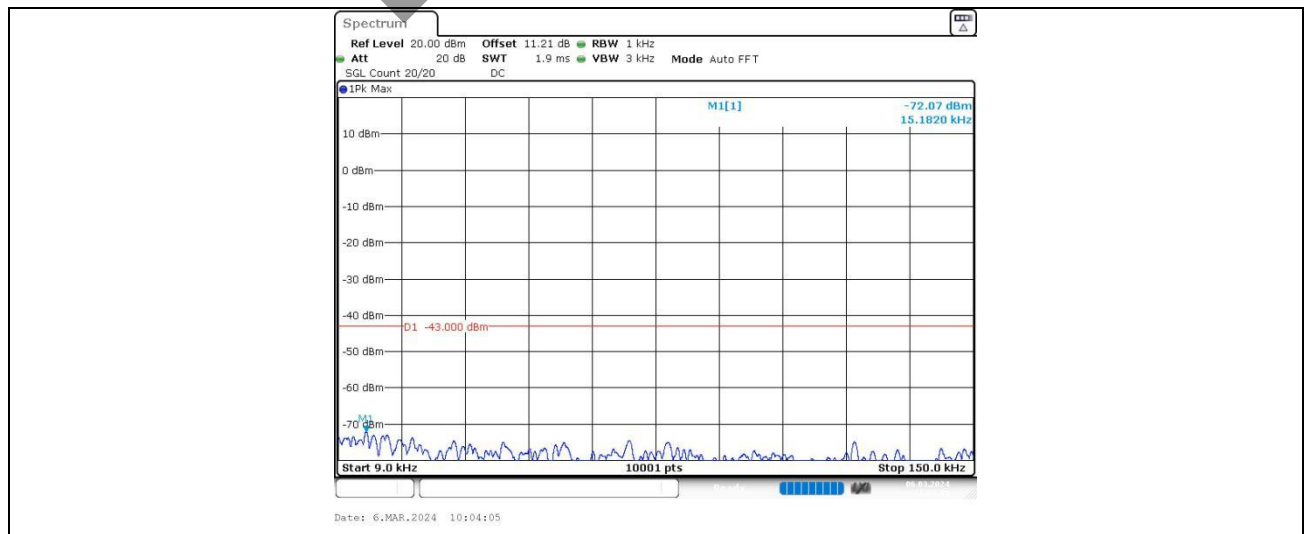



BUREAU VERITAS

Test Report No.: W7L-P23120015R102

GPRS1900-512-0.009~0.15MHz

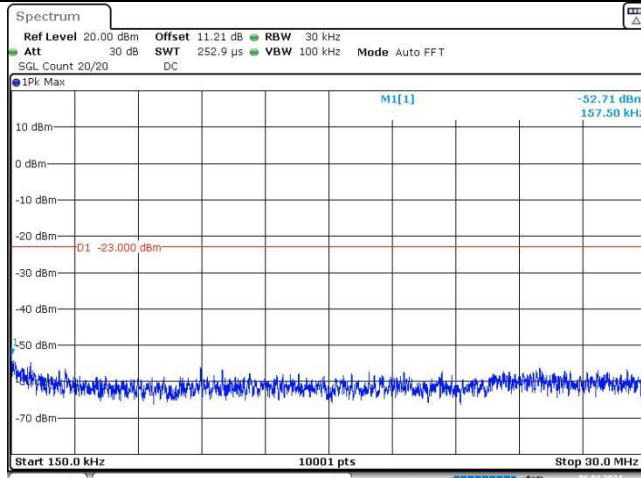

Date: 6.MAR.2024 10:04:10

GPRS1900-512-0.15~30MHz

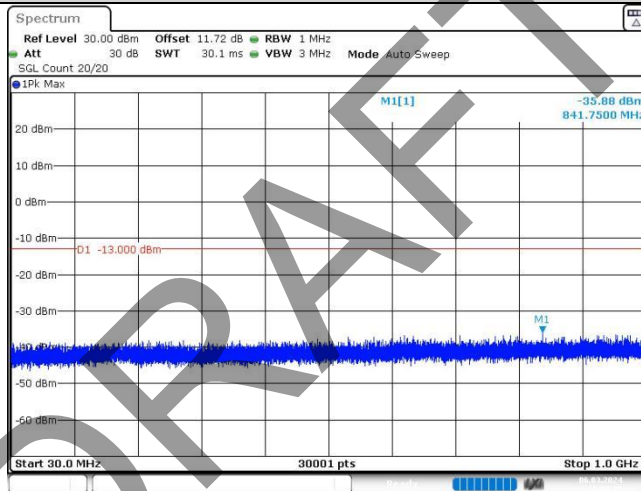

Date: 6.MAR.2024 10:04:15

GPRS1900-512-30~1000MHz

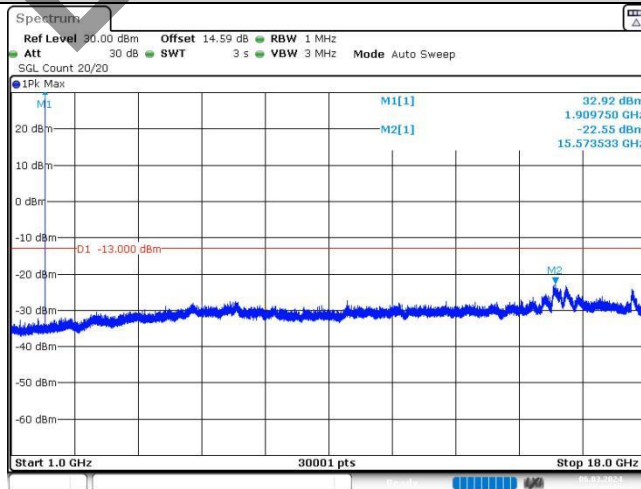

Date: 6.MAR.2024 10:05:25

GPRS1900-512-1000~18000MHz

BV 7Layers Communications Technology (Shenzhen) Co., Ltd

Room B37, Warehouse A5, No.3 Chiwan 4th Road, Zhaoshang Street, Nanshan District Shenzhen, Guangdong, People's Republic of China

Tel: +86 755 8869 6566
Fax: +86 755 8869 6577

Email: customerservice.sw@bureauveritas.com



BUREAU VERITAS

Test Report No.: W7L-P23120015R102

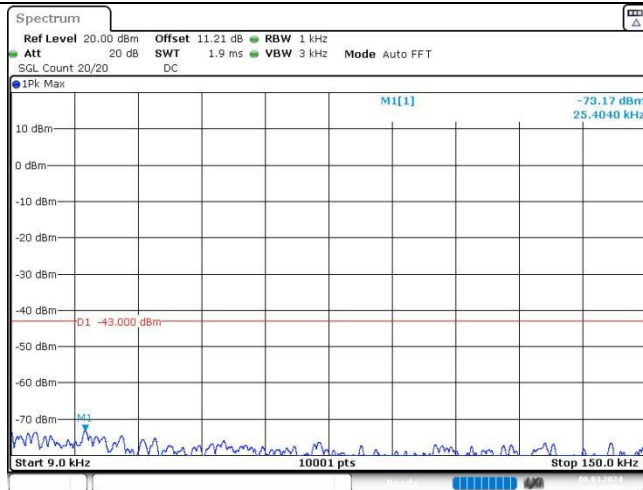

Date: 6.MAR.2024 10:05:31

GPRS1900-661-0.009~0.15MHz

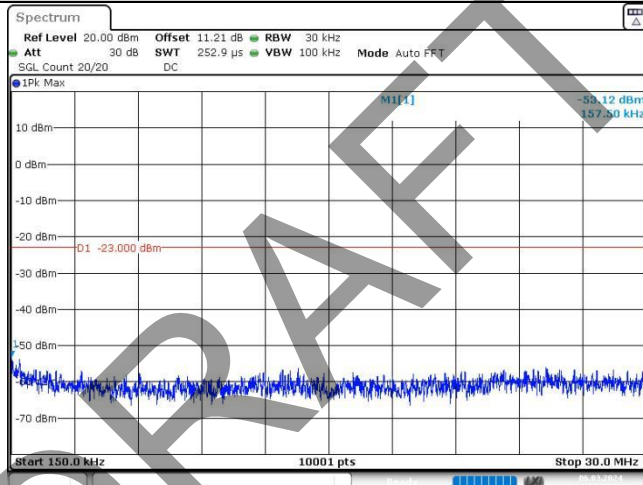

Date: 6.MAR.2024 10:05:36

GPRS1900-661-0.15~30MHz

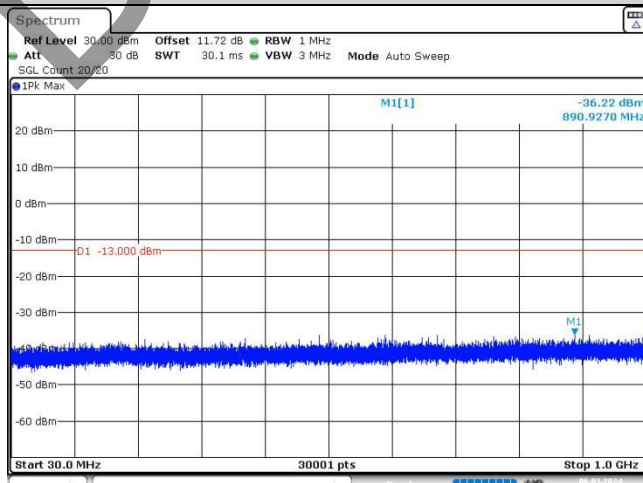

Date: 6.MAR.2024 10:05:41

GPRS1900-661-30~1000MHz

BV 7Layers Communications Technology (Shenzhen) Co., Ltd

Room B37, Warehouse A5, No.3 Chiwan 4th Road, Zhaoshang Street, Nanshan District Shenzhen, Guangdong, People's Republic of China

Tel: +86 755 8869 6566
Fax: +86 755 8869 6577

Email: customerservice.sw@bureauveritas.com



BUREAU VERITAS

Test Report No.: W7L-P23120015R102

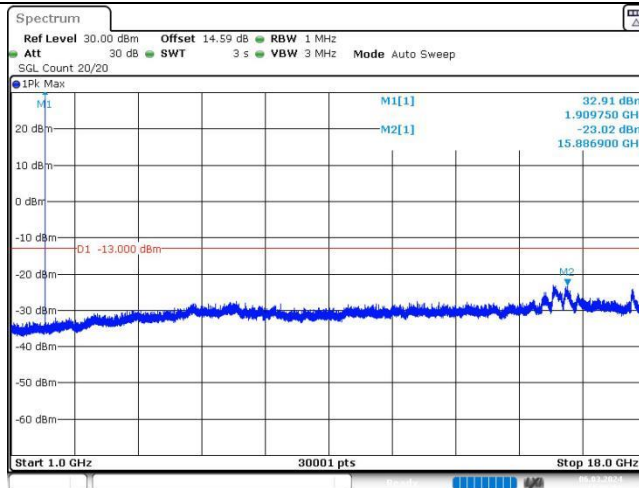

Date: 6.MAR.2024 10:06:51

GPRS1900-661-1000~18000MHz



Date: 6.MAR.2024 10:06:57

GPRS1900-810-0.009~0.15MHz

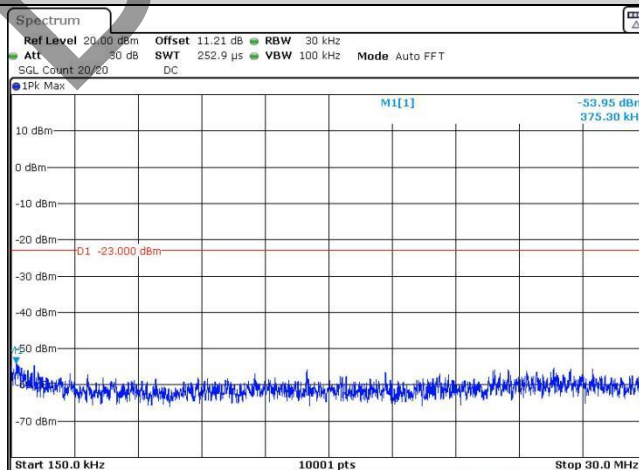

Date: 6.MAR.2024 10:07:01

GPRS1900-810-0.15~30MHz



BUREAU VERITAS

Test Report No.: W7L-P23120015R102

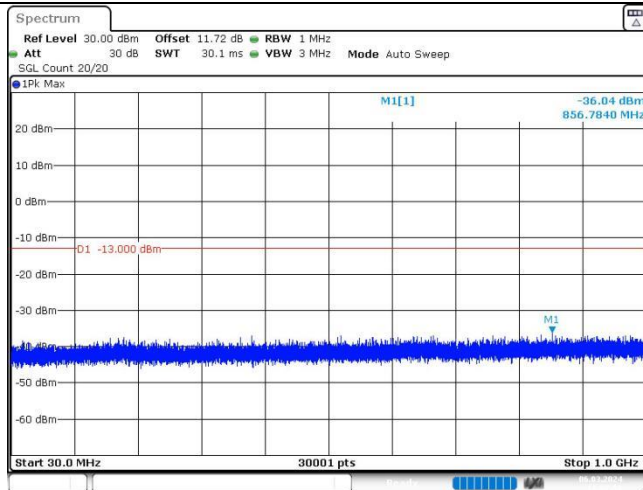

Date: 6.MAR.2024 10:07:07

GPRS1900-810-30~1000MHz

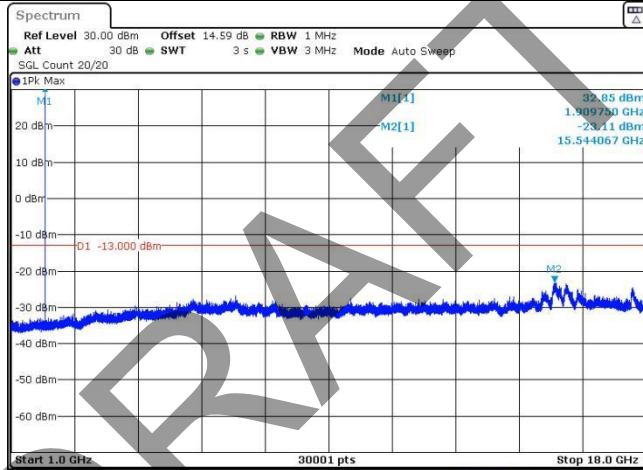

Date: 6.MAR.2024 10:08:16

GPRS1900-810-1000~18000MHz

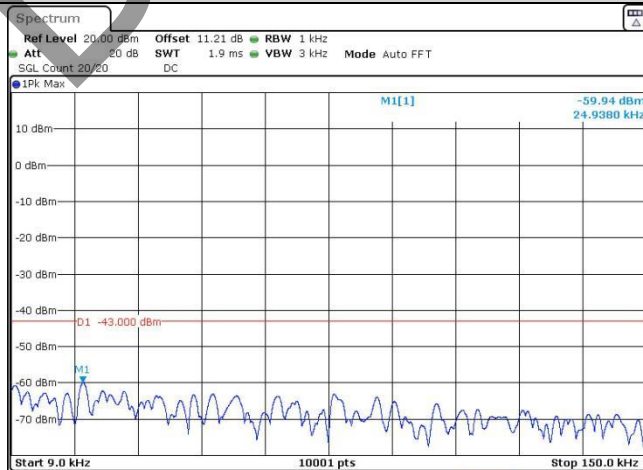

Date: 6.MAR.2024 10:11:19

EGPRS1900-512-0.009~0.15MHz

BV 7Layers Communications Technology (Shenzhen) Co., Ltd

Room B37, Warehouse A5, No.3 Chiwan 4th Road, Zhaoshang Street, Nanshan District Shenzhen, Guangdong, People's Republic of China

Tel: +86 755 8869 6566
Fax: +86 755 8869 6577

Email: customerservice.sw@bureauveritas.com



BUREAU VERITAS

Test Report No.: W7L-P23120015R102

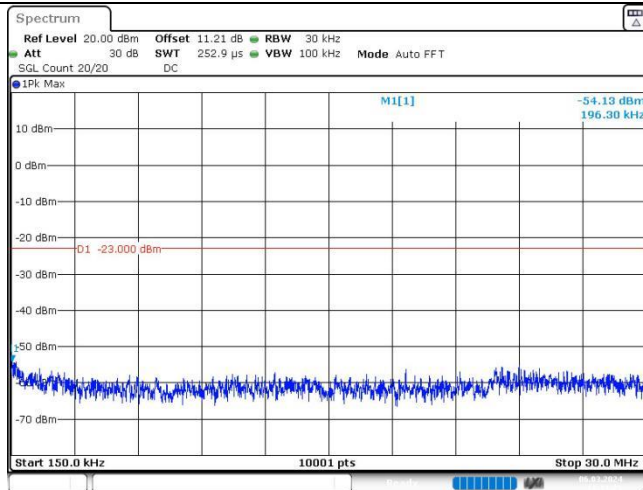

Date: 6.MAR.2024 10:11:23

EGPRS1900-512-0.15~30MHz

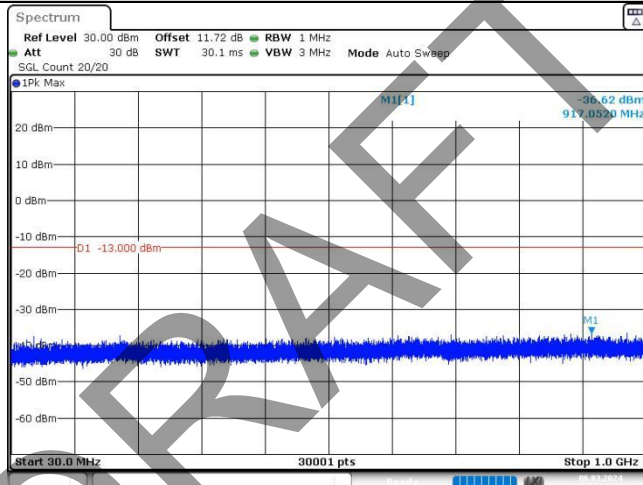

Date: 6.MAR.2024 10:11:29

EGPRS1900-512-30~1000MHz

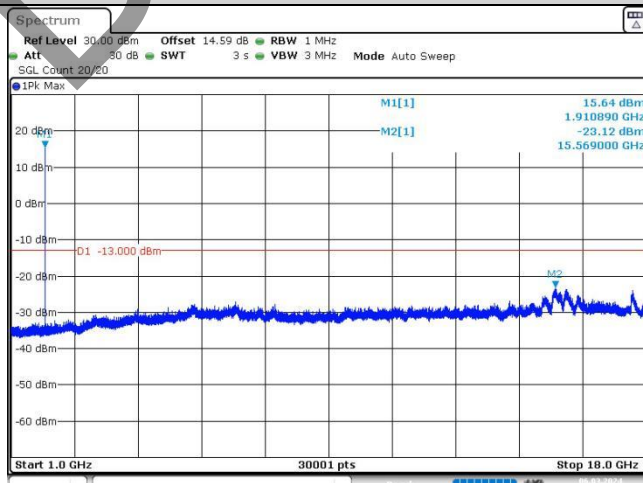

Date: 6.MAR.2024 10:12:38

EGPRS1900-512-1000~18000MHz

BV 7Layers Communications Technology (Shenzhen) Co., Ltd

Room B37, Warehouse A5, No.3 Chiwan 4th Road, Zhaoshang Street, Nanshan District Shenzhen, Guangdong, People's Republic of China

Tel: +86 755 8869 6566
Fax: +86 755 8869 6577

Email: customerservice.sw@bureauveritas.com



BUREAU VERITAS

Test Report No.: W7L-P23120015R102

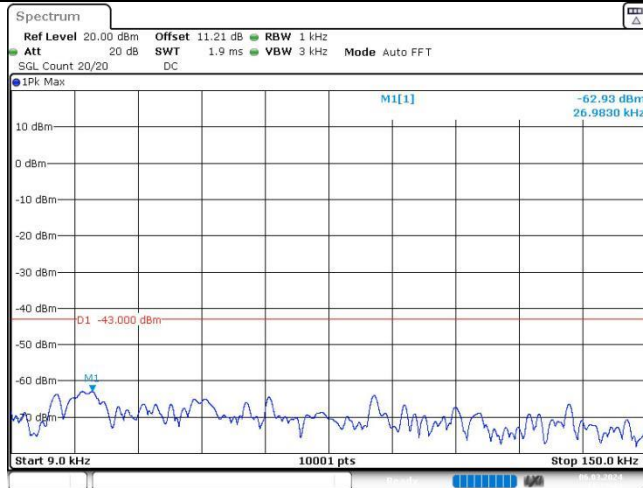

Date: 6.MAR.2024 10:12:44

EGPRS1900-661-0.009~0.15MHz

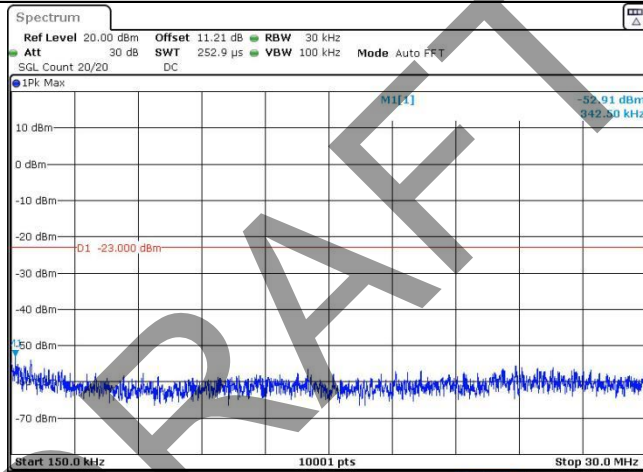

Date: 6.MAR.2024 10:12:49

EGPRS1900-661-0.15~30MHz

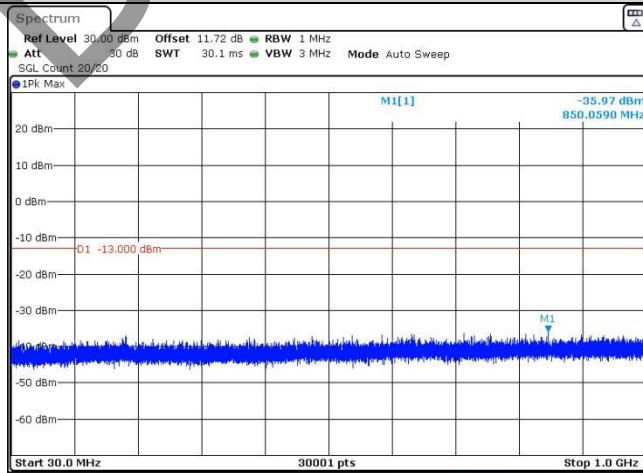

Date: 6.MAR.2024 10:12:54

EGPRS1900-661-30~1000MHz



BUREAU VERITAS

Test Report No.: W7L-P23120015R102

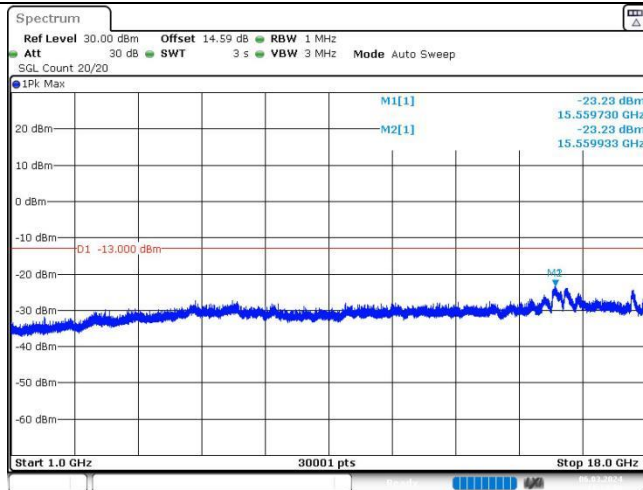

Date: 6.MAR.2024 10:14:04

EGPRS1900-661-1000~18000MHz

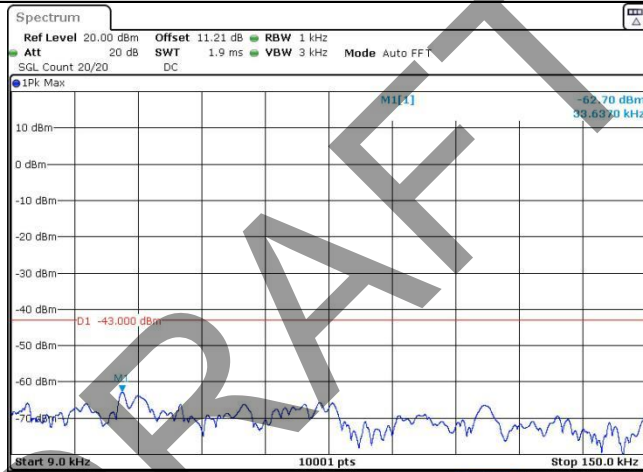

Date: 6.MAR.2024 10:14:15

EGPRS1900-810-0.009~0.15MHz

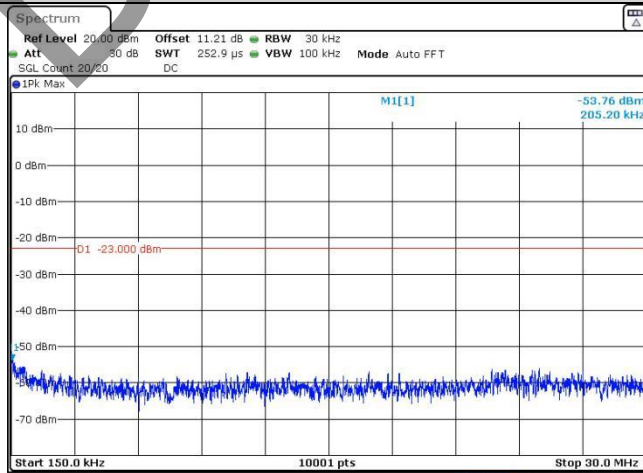

Date: 6.MAR.2024 10:14:20

EGPRS1900-810-0.15~30MHz

BV 7Layers Communications Technology (Shenzhen) Co., Ltd

Room B37, Warehouse A5, No.3 Chiwan 4th Road, Zhaoshang Street, Nanshan District Shenzhen, Guangdong, People's Republic of China

Tel: +86 755 8869 6566
Fax: +86 755 8869 6577

Email: customerservice.sw@bureauveritas.com



**BUREAU
VERITAS**

Test Report No.: W7L-P23120015R102

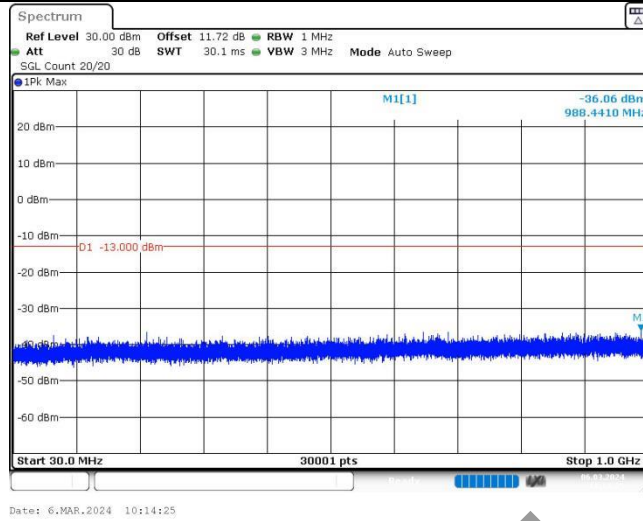

EGPRS1900-810-30~1000MHz

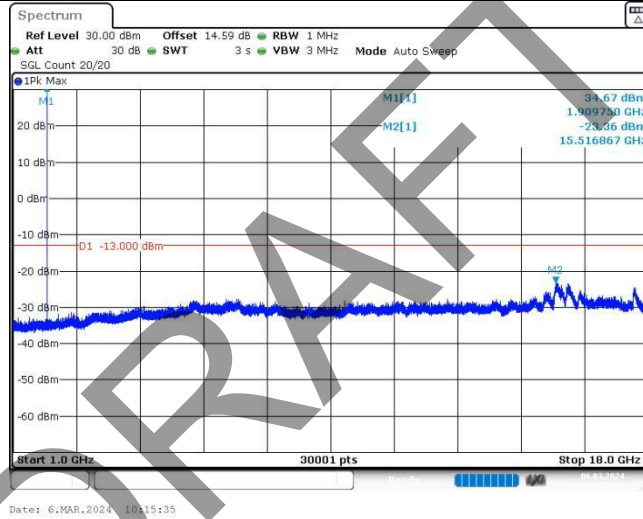

EGPRS1900-810-1000~1800MHz

BAND 2 TEST RESULT

Band	Bandwidth	Modulation	Channel	RB Size	RB Start	NB Index	Start Freq	Stop Freq	Result (dBm)	Verdict
Band2	1.4MHz	18607	QPSK	1	0	Low	0.009	0.15	-59.79	PASS
Band2	1.4MHz	18607	QPSK	1	0	Low	0.15	30	-40.81	PASS
Band2	1.4MHz	18607	QPSK	1	0	Low	30	1000	-24.94	PASS
Band2	1.4MHz	18607	QPSK	1	0	Low	1000	5000	-28.61	PASS
Band2	1.4MHz	18607	QPSK	1	0	Low	5000	12000	-43.49	PASS
Band2	1.4MHz	18607	QPSK	1	0	Low	12000	26500	-38.68	PASS
Band2	1.4MHz	18900	QPSK	1	0	Low	0.009	0.15	-61.03	PASS
Band2	1.4MHz	18900	QPSK	1	0	Low	0.15	30	-40.41	PASS
Band2	1.4MHz	18900	QPSK	1	0	Low	30	1000	-24.88	PASS
Band2	1.4MHz	18900	QPSK	1	0	Low	1000	5000	-28.66	PASS
Band2	1.4MHz	18900	QPSK	1	0	Low	5000	12000	-43.54	PASS
Band2	1.4MHz	18900	QPSK	1	0	Low	12000	26500	-38.77	PASS
Band2	1.4MHz	19193	QPSK	1	0	High	0.009	0.15	-61.41	PASS

BV 7Layers Communications Technology (Shenzhen) Co., Ltd

Room B37, Warehouse A5, No.3 Chiwan 4th Road, Zhaoshang Street, Nanshan District Shenzhen, Guangdong, People's Republic of China

Tel: +86 755 8869 6566
Fax: +86 755 8869 6577

Email: customerservice.sw@bureauveritas.com



**BUREAU
VERITAS**

Test Report No.: W7L-P23120015R102

Band2	1.4MHz	19193	QPSK	1	0	High	0.15	30	-41.01	PASS
Band2	1.4MHz	19193	QPSK	1	0	High	30	1000	-24.72	PASS
Band2	1.4MHz	19193	QPSK	1	0	High	1000	5000	-27.77	PASS
Band2	1.4MHz	19193	QPSK	1	0	High	5000	12000	-43.5	PASS
Band2	1.4MHz	19193	QPSK	1	0	High	12000	26500	-38.69	PASS
Band2	1.4MHz	18607	16QAM	1	0	Low	0.009	0.15	-59.51	PASS
Band2	1.4MHz	18607	16QAM	1	0	Low	0.15	30	-40.59	PASS
Band2	1.4MHz	18607	16QAM	1	0	Low	30	1000	-23.94	PASS
Band2	1.4MHz	18607	16QAM	1	0	Low	1000	5000	-30.45	PASS
Band2	1.4MHz	18607	16QAM	1	0	Low	5000	12000	-43.63	PASS
Band2	1.4MHz	18607	16QAM	1	0	Low	12000	26500	-39.01	PASS
Band2	1.4MHz	18900	16QAM	1	0	Low	0.009	0.15	-60.5	PASS
Band2	1.4MHz	18900	16QAM	1	0	Low	0.15	30	-41.27	PASS
Band2	1.4MHz	18900	16QAM	1	0	Low	30	1000	-24.76	PASS
Band2	1.4MHz	18900	16QAM	1	0	Low	1000	5000	-30.4	PASS
Band2	1.4MHz	18900	16QAM	1	0	Low	5000	12000	-43.53	PASS
Band2	1.4MHz	18900	16QAM	1	0	Low	12000	26500	-38.79	PASS
Band2	1.4MHz	19193	16QAM	1	0	High	0.009	0.15	-60.8	PASS
Band2	1.4MHz	19193	16QAM	1	0	High	0.15	30	-40.94	PASS
Band2	1.4MHz	19193	16QAM	1	0	High	30	1000	-24.52	PASS
Band2	1.4MHz	19193	16QAM	1	0	High	1000	5000	-27.95	PASS
Band2	1.4MHz	19193	16QAM	1	0	High	5000	12000	-43.62	PASS
Band2	1.4MHz	19193	16QAM	1	0	High	12000	26500	-38.7	PASS
Band2	3MHz	18615	QPSK	1	0	Low	0.009	0.15	-60.13	PASS
Band2	3MHz	18615	QPSK	1	0	Low	0.15	30	-40.51	PASS
Band2	3MHz	18615	QPSK	1	0	Low	30	1000	-25.15	PASS
Band2	3MHz	18615	QPSK	1	0	Low	1000	5000	-27.74	PASS
Band2	3MHz	18615	QPSK	1	0	Low	5000	12000	-43.3	PASS
Band2	3MHz	18615	QPSK	1	0	Low	12000	26500	-38.53	PASS
Band2	3MHz	18900	QPSK	1	0	Low	0.009	0.15	-61.15	PASS
Band2	3MHz	18900	QPSK	1	0	Low	0.15	30	-40.54	PASS
Band2	3MHz	18900	QPSK	1	0	Low	30	1000	-24.88	PASS
Band2	3MHz	18900	QPSK	1	0	Low	1000	5000	-28.06	PASS
Band2	3MHz	18900	QPSK	1	0	Low	5000	12000	-43.38	PASS
Band2	3MHz	18900	QPSK	1	0	Low	12000	26500	-38.57	PASS
Band2	3MHz	19185	QPSK	1	0	High	0.009	0.15	-60.52	PASS
Band2	3MHz	19185	QPSK	1	0	High	0.15	30	-40.35	PASS
Band2	3MHz	19185	QPSK	1	0	High	30	1000	-24.71	PASS
Band2	3MHz	19185	QPSK	1	0	High	1000	5000	-29.97	PASS
Band2	3MHz	19185	QPSK	1	0	High	5000	12000	-43.19	PASS
Band2	3MHz	19185	QPSK	1	0	High	12000	26500	-38.54	PASS
Band2	3MHz	18615	16QAM	1	0	Low	0.009	0.15	-59.02	PASS
Band2	3MHz	18615	16QAM	1	0	Low	0.15	30	-40.09	PASS
Band2	3MHz	18615	16QAM	1	0	Low	30	1000	-25.15	PASS
Band2	3MHz	18615	16QAM	1	0	Low	1000	5000	-27.92	PASS
Band2	3MHz	18615	16QAM	1	0	Low	5000	12000	-43.43	PASS
Band2	3MHz	18615	16QAM	1	0	Low	12000	26500	-38.56	PASS
Band2	3MHz	18900	16QAM	1	0	Low	0.009	0.15	-58.68	PASS
Band2	3MHz	18900	16QAM	1	0	Low	0.15	30	-40.38	PASS
Band2	3MHz	18900	16QAM	1	0	Low	30	1000	-24.91	PASS
Band2	3MHz	18900	16QAM	1	0	Low	1000	5000	-27.03	PASS
Band2	3MHz	18900	16QAM	1	0	Low	5000	12000	-43.45	PASS

BV 7Layers Communications Technology
(Shenzhen) Co., Ltd

Room B37, Warehouse A5, No.3 Chiwan 4th Road,
Zhaoshang Street, Nanshan District Shenzhen,
Guangdong, People's Republic of China

Tel: +86 755 8869 6566
Fax: +86 755 8869 6577
Email: customerservice.sw@bureauveritas.com



BUREAU
VERITAS

Test Report No.: W7L-P23120015R102

Band2	3MHz	18900	16QAM	1	0	Low	12000	26500	-38.59	PASS
Band2	3MHz	19185	16QAM	1	0	High	0.009	0.15	-60.47	PASS
Band2	3MHz	19185	16QAM	1	0	High	0.15	30	-40.19	PASS
Band2	3MHz	19185	16QAM	1	0	High	30	1000	-24.64	PASS
Band2	3MHz	19185	16QAM	1	0	High	1000	5000	-27.59	PASS
Band2	3MHz	19185	16QAM	1	0	High	5000	12000	-43.17	PASS
Band2	3MHz	19185	16QAM	1	0	High	12000	26500	-38.43	PASS
Band2	5MHz	18625	QPSK	1	0	Low	0.009	0.15	-60.66	PASS
Band2	5MHz	18625	QPSK	1	0	Low	0.15	30	-39.81	PASS
Band2	5MHz	18625	QPSK	1	0	Low	30	1000	-24.87	PASS
Band2	5MHz	18625	QPSK	1	0	Low	1000	5000	-28.48	PASS
Band2	5MHz	18625	QPSK	1	0	Low	5000	12000	-43.52	PASS
Band2	5MHz	18625	QPSK	1	0	Low	12000	26500	-38.76	PASS
Band2	5MHz	18900	QPSK	1	0	Low	0.009	0.15	-60.44	PASS
Band2	5MHz	18900	QPSK	1	0	Low	0.15	30	-41.56	PASS
Band2	5MHz	18900	QPSK	1	0	Low	30	1000	-24.68	PASS
Band2	5MHz	18900	QPSK	1	0	Low	1000	5000	-29.27	PASS
Band2	5MHz	18900	QPSK	1	0	Low	5000	12000	-43.19	PASS
Band2	5MHz	18900	QPSK	1	0	Low	12000	26500	-38.7	PASS
Band2	5MHz	19175	QPSK	1	0	High	0.009	0.15	-61.36	PASS
Band2	5MHz	19175	QPSK	1	0	High	0.15	30	-40.22	PASS
Band2	5MHz	19175	QPSK	1	0	High	30	1000	-24.25	PASS
Band2	5MHz	19175	QPSK	1	0	High	1000	5000	-27.66	PASS
Band2	5MHz	19175	QPSK	1	0	High	5000	12000	-43.45	PASS
Band2	5MHz	19175	QPSK	1	0	High	12000	26500	-38.63	PASS
Band2	5MHz	18625	16QAM	1	0	Low	0.009	0.15	-58.56	PASS
Band2	5MHz	18625	16QAM	1	0	Low	0.15	30	-40.94	PASS
Band2	5MHz	18625	16QAM	1	0	Low	30	1000	-24.83	PASS
Band2	5MHz	18625	16QAM	1	0	Low	1000	5000	-30.47	PASS
Band2	5MHz	18625	16QAM	1	0	Low	5000	12000	-43.4	PASS
Band2	5MHz	18625	16QAM	1	0	Low	12000	26500	-38.75	PASS
Band2	5MHz	18900	16QAM	1	0	Low	0.009	0.15	-59.96	PASS
Band2	5MHz	18900	16QAM	1	0	Low	0.15	30	-40.49	PASS
Band2	5MHz	18900	16QAM	1	0	Low	30	1000	-24.22	PASS
Band2	5MHz	18900	16QAM	1	0	Low	1000	5000	-30.25	PASS
Band2	5MHz	18900	16QAM	1	0	Low	5000	12000	-43.38	PASS
Band2	5MHz	18900	16QAM	1	0	Low	12000	26500	-38.57	PASS
Band2	5MHz	19175	16QAM	1	0	High	0.009	0.15	-60.56	PASS
Band2	5MHz	19175	16QAM	1	0	High	0.15	30	-40.68	PASS
Band2	5MHz	19175	16QAM	1	0	High	30	1000	-24.62	PASS
Band2	5MHz	19175	16QAM	1	0	High	1000	5000	-27.94	PASS
Band2	5MHz	19175	16QAM	1	0	High	5000	12000	-43.21	PASS
Band2	5MHz	19175	16QAM	1	0	High	12000	26500	-38.47	PASS
Band2	10MHz	18650	QPSK	1	0	Low	0.009	0.15	-60.51	PASS
Band2	10MHz	18650	QPSK	1	0	Low	0.15	30	-41.22	PASS
Band2	10MHz	18650	QPSK	1	0	Low	30	1000	-24.87	PASS
Band2	10MHz	18650	QPSK	1	0	Low	1000	5000	-28.32	PASS
Band2	10MHz	18650	QPSK	1	0	Low	5000	12000	-43.41	PASS
Band2	10MHz	18650	QPSK	1	0	Low	12000	26500	-38.56	PASS
Band2	10MHz	18900	QPSK	1	0	Low	0.009	0.15	-61.45	PASS
Band2	10MHz	18900	QPSK	1	0	Low	0.15	30	-39.93	PASS
Band2	10MHz	18900	QPSK	1	0	Low	30	1000	-24.46	PASS

BV 7Layers Communications Technology
(Shenzhen) Co., Ltd

Room B37, Warehouse A5, No.3 Chiwan 4th Road,
Zhaoshang Street, Nanshan District Shenzhen,
Guangdong, People's Republic of China

Tel: +86 755 8869 6566
Fax: +86 755 8869 6577
Email: customerservice.sw@bureauveritas.com



**BUREAU
VERITAS**

Test Report No.: W7L-P23120015R102

Band2	10MHz	18900	QPSK	1	0	Low	1000	5000	-27.65	PASS
Band2	10MHz	18900	QPSK	1	0	Low	5000	12000	-43.33	PASS
Band2	10MHz	18900	QPSK	1	0	Low	12000	26500	-38.46	PASS
Band2	10MHz	19150	QPSK	1	0	High	0.009	0.15	-61.04	PASS
Band2	10MHz	19150	QPSK	1	0	High	0.15	30	-39.87	PASS
Band2	10MHz	19150	QPSK	1	0	High	30	1000	-24.96	PASS
Band2	10MHz	19150	QPSK	1	0	High	1000	5000	-27.62	PASS
Band2	10MHz	19150	QPSK	1	0	High	5000	12000	-43.43	PASS
Band2	10MHz	19150	QPSK	1	0	High	12000	26500	-38.61	PASS
Band2	10MHz	18650	16QAM	1	0	Low	0.009	0.15	-59.68	PASS
Band2	10MHz	18650	16QAM	1	0	Low	0.15	30	-40.47	PASS
Band2	10MHz	18650	16QAM	1	0	Low	30	1000	-24.99	PASS
Band2	10MHz	18650	16QAM	1	0	Low	1000	5000	-28.92	PASS
Band2	10MHz	18650	16QAM	1	0	Low	5000	12000	-43.56	PASS
Band2	10MHz	18650	16QAM	1	0	Low	12000	26500	-38.7	PASS
Band2	10MHz	18900	16QAM	1	0	Low	0.009	0.15	-59.72	PASS
Band2	10MHz	18900	16QAM	1	0	Low	0.15	30	-40.06	PASS
Band2	10MHz	18900	16QAM	1	0	Low	30	1000	-24.9	PASS
Band2	10MHz	18900	16QAM	1	0	Low	1000	5000	-30.32	PASS
Band2	10MHz	18900	16QAM	1	0	Low	5000	12000	-43.31	PASS
Band2	10MHz	18900	16QAM	1	0	Low	12000	26500	-38.68	PASS
Band2	10MHz	19150	16QAM	1	0	High	0.009	0.15	-60.05	PASS
Band2	10MHz	19150	16QAM	1	0	High	0.15	30	-40.66	PASS
Band2	10MHz	19150	16QAM	1	0	High	30	1000	-24.08	PASS
Band2	10MHz	19150	16QAM	1	0	High	1000	5000	-27.64	PASS
Band2	10MHz	19150	16QAM	1	0	High	5000	12000	-43.56	PASS
Band2	10MHz	19150	16QAM	1	0	High	12000	26500	-38.65	PASS
Band2	15MHz	18675	QPSK	1	0	Low	0.009	0.15	-61.04	PASS
Band2	15MHz	18675	QPSK	1	0	Low	0.15	30	-39.51	PASS
Band2	15MHz	18675	QPSK	1	0	Low	30	1000	-24.79	PASS
Band2	15MHz	18675	QPSK	1	0	Low	1000	5000	-30.31	PASS
Band2	15MHz	18675	QPSK	1	0	Low	5000	12000	-43.53	PASS
Band2	15MHz	18675	QPSK	1	0	Low	12000	26500	-38.75	PASS
Band2	15MHz	18900	QPSK	1	0	Low	0.009	0.15	-60.03	PASS
Band2	15MHz	18900	QPSK	1	0	Low	0.15	30	-40.8	PASS
Band2	15MHz	18900	QPSK	1	0	Low	30	1000	-24.46	PASS
Band2	15MHz	18900	QPSK	1	0	Low	1000	5000	-28.21	PASS
Band2	15MHz	18900	QPSK	1	0	Low	5000	12000	-43.42	PASS
Band2	15MHz	18900	QPSK	1	0	Low	12000	26500	-38.56	PASS
Band2	15MHz	19125	QPSK	1	0	High	0.009	0.15	-60.49	PASS
Band2	15MHz	19125	QPSK	1	0	High	0.15	30	-40.29	PASS
Band2	15MHz	19125	QPSK	1	0	High	30	1000	-24.94	PASS
Band2	15MHz	19125	QPSK	1	0	High	1000	5000	-30.23	PASS
Band2	15MHz	19125	QPSK	1	0	High	5000	12000	-43.27	PASS
Band2	15MHz	19125	QPSK	1	0	High	12000	26500	-38.67	PASS
Band2	15MHz	18675	16QAM	1	0	Low	0.009	0.15	-59.5	PASS
Band2	15MHz	18675	16QAM	1	0	Low	0.15	30	-40.9	PASS
Band2	15MHz	18675	16QAM	1	0	Low	30	1000	-24.82	PASS
Band2	15MHz	18675	16QAM	1	0	Low	1000	5000	-28.79	PASS
Band2	15MHz	18675	16QAM	1	0	Low	5000	12000	-43.48	PASS
Band2	15MHz	18675	16QAM	1	0	Low	12000	26500	-38.69	PASS
Band2	15MHz	18900	16QAM	1	0	Low	0.009	0.15	-59.84	PASS

BV 7Layers Communications Technology
(Shenzhen) Co., Ltd

Room B37, Warehouse A5, No.3 Chiwan 4th Road,
Zhaoshang Street, Nanshan District Shenzhen,
Guangdong, People's Republic of China

Tel: +86 755 8869 6566
Fax: +86 755 8869 6577
Email: customerservice.sw@bureauveritas.com



**BUREAU
VERITAS**

Test Report No.: W7L-P23120015R102

Band2	15MHz	18900	16QAM	1	0	Low	0.15	30	-38.91	PASS
Band2	15MHz	18900	16QAM	1	0	Low	30	1000	-24.49	PASS
Band2	15MHz	18900	16QAM	1	0	Low	1000	5000	-29.8	PASS
Band2	15MHz	18900	16QAM	1	0	Low	5000	12000	-43.27	PASS
Band2	15MHz	18900	16QAM	1	0	Low	12000	26500	-38.5	PASS
Band2	15MHz	19125	16QAM	1	0	High	0.009	0.15	-60.86	PASS
Band2	15MHz	19125	16QAM	1	0	High	0.15	30	-40.63	PASS
Band2	15MHz	19125	16QAM	1	0	High	30	1000	-24.42	PASS
Band2	15MHz	19125	16QAM	1	0	High	1000	5000	-27.78	PASS
Band2	15MHz	19125	16QAM	1	0	High	5000	12000	-43.46	PASS
Band2	15MHz	19125	16QAM	1	0	High	12000	26500	-38.77	PASS
Band2	20MHz	18700	QPSK	1	0	Low	0.009	0.15	-60.07	PASS
Band2	20MHz	18700	QPSK	1	0	Low	0.15	30	-37.72	PASS
Band2	20MHz	18700	QPSK	1	0	Low	30	1000	-24.11	PASS
Band2	20MHz	18700	QPSK	1	0	Low	1000	5000	-30.17	PASS
Band2	20MHz	18700	QPSK	1	0	Low	5000	12000	-43.51	PASS
Band2	20MHz	18700	QPSK	1	0	Low	12000	26500	-38.63	PASS
Band2	20MHz	18900	QPSK	1	0	Low	0.009	0.15	-59.19	PASS
Band2	20MHz	18900	QPSK	1	0	Low	0.15	30	-39.64	PASS
Band2	20MHz	18900	QPSK	1	0	Low	30	1000	-24.77	PASS
Band2	20MHz	18900	QPSK	1	0	Low	1000	5000	-28.51	PASS
Band2	20MHz	18900	QPSK	1	0	Low	5000	12000	-43.44	PASS
Band2	20MHz	18900	QPSK	1	0	Low	12000	26500	-38.61	PASS
Band2	20MHz	19100	QPSK	1	0	High	0.009	0.15	-60.59	PASS
Band2	20MHz	19100	QPSK	1	0	High	0.15	30	-40.66	PASS
Band2	20MHz	19100	QPSK	1	0	High	30	1000	-24.97	PASS
Band2	20MHz	19100	QPSK	1	0	High	1000	5000	-27.63	PASS
Band2	20MHz	19100	QPSK	1	0	High	5000	12000	-43.47	PASS
Band2	20MHz	19100	QPSK	1	0	High	12000	26500	-38.78	PASS
Band2	20MHz	18700	16QAM	1	0	Low	0.009	0.15	-60	PASS
Band2	20MHz	18700	16QAM	1	0	Low	0.15	30	-41.07	PASS
Band2	20MHz	18700	16QAM	1	0	Low	30	1000	-23.68	PASS
Band2	20MHz	18700	16QAM	1	0	Low	1000	5000	-30.42	PASS
Band2	20MHz	18700	16QAM	1	0	Low	5000	12000	-43.29	PASS
Band2	20MHz	18700	16QAM	1	0	Low	12000	26500	-38.74	PASS
Band2	20MHz	18900	16QAM	1	0	Low	0.009	0.15	-60.75	PASS
Band2	20MHz	18900	16QAM	1	0	Low	0.15	30	-40.54	PASS
Band2	20MHz	18900	16QAM	1	0	Low	30	1000	-24.28	PASS
Band2	20MHz	18900	16QAM	1	0	Low	1000	5000	-28.38	PASS
Band2	20MHz	18900	16QAM	1	0	Low	5000	12000	-43.34	PASS
Band2	20MHz	18900	16QAM	1	0	Low	12000	26500	-38.66	PASS
Band2	20MHz	19100	16QAM	1	0	High	0.009	0.15	-59.83	PASS
Band2	20MHz	19100	16QAM	1	0	High	0.15	30	-40.95	PASS
Band2	20MHz	19100	16QAM	1	0	High	30	1000	-24.62	PASS
Band2	20MHz	19100	16QAM	1	0	High	1000	5000	-30.29	PASS
Band2	20MHz	19100	16QAM	1	0	High	5000	12000	-43.32	PASS
Band2	20MHz	19100	16QAM	1	0	High	12000	26500	-38.7	PASS



BUREAU VERITAS

Test Report No.: W7L-P23120015R102

BAND 2 TEST GRAPHS

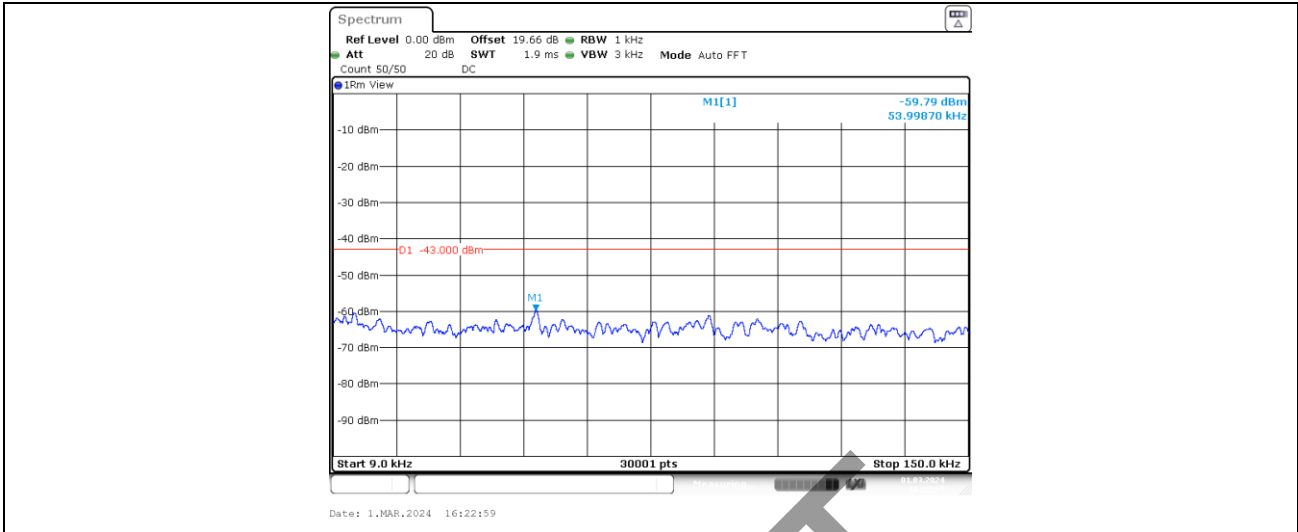

Band2-1.4MHz-QPSK-18607-1-0-Low-0.009-0.15--59.79-PASS

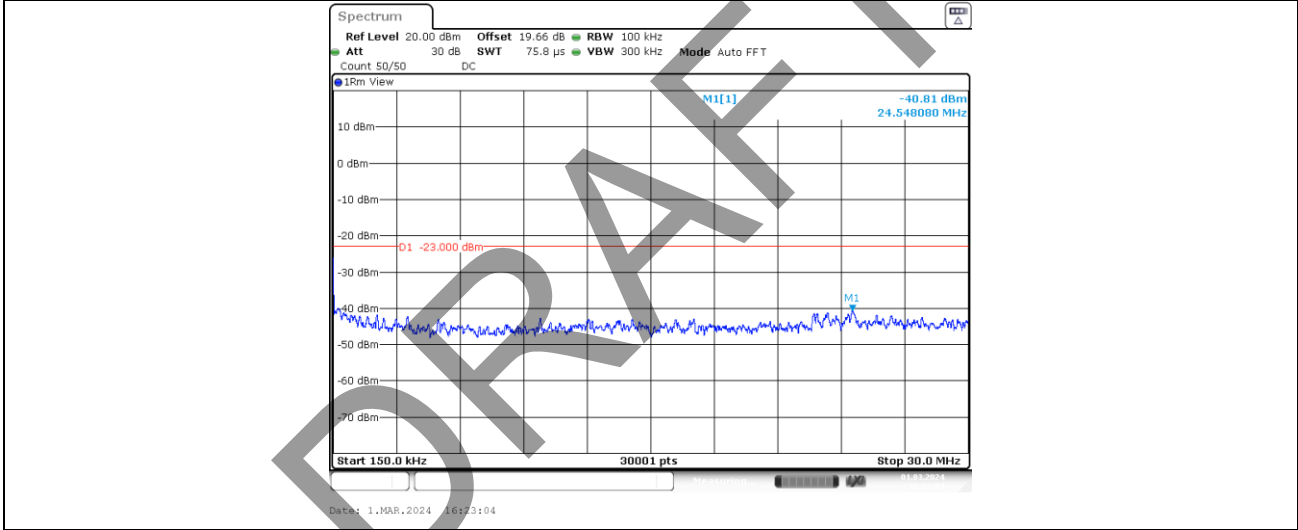

Band2-1.4MHz-QPSK-18607-1-0-Low-0.15-30--40.81-PASS

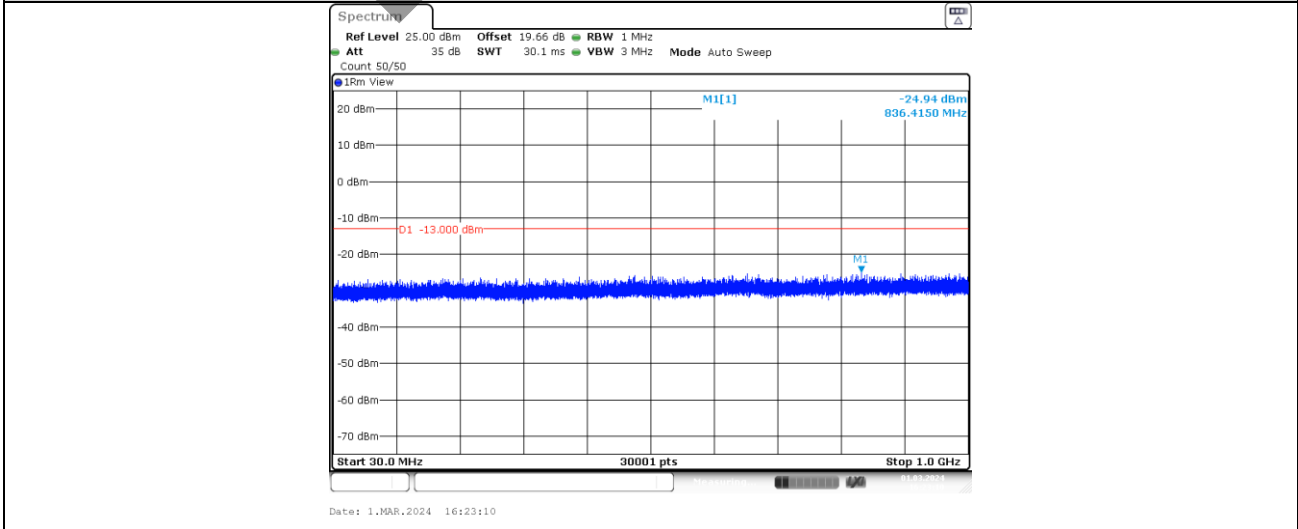



BUREAU VERITAS

Test Report No.: W7L-P23120015R102

Band2-1.4MHz-QPSK-18607-1-0-Low-30-1000--24.94-PASS

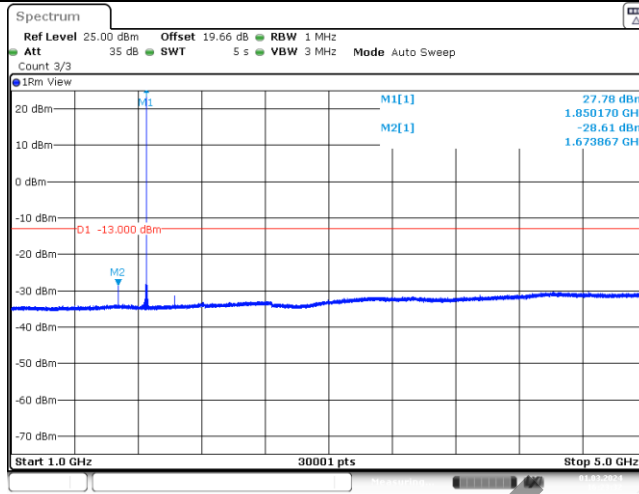

Date: 1.MAR.2024 16:23:32

Band2-1.4MHz-QPSK-18607-1-0-Low-1000-5000--28.61-PASS

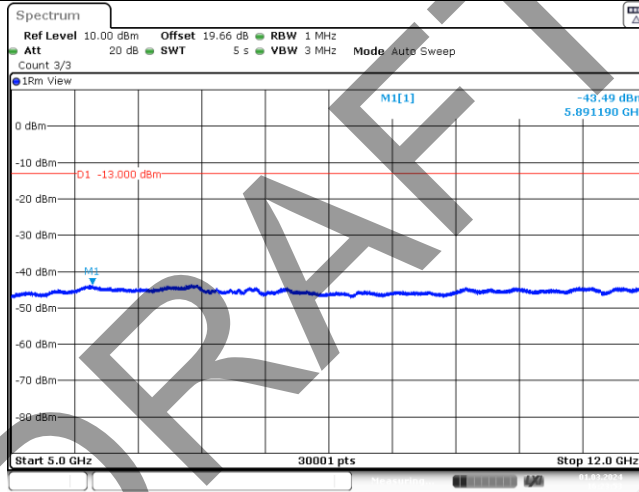

Date: 1.MAR.2024 16:23:54

Band2-1.4MHz-QPSK-18607-1-0-Low-5000-12000--43.49-PASS

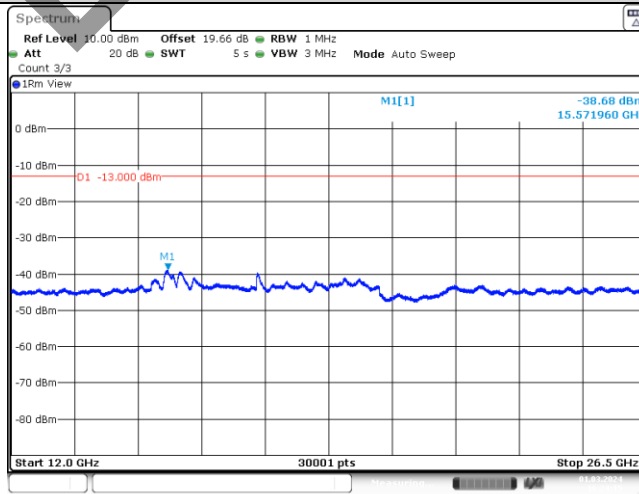

Date: 1.MAR.2024 16:24:15

Band2-1.4MHz-QPSK-18607-1-0-Low-12000-26500--38.68-PASS

BV 7Layers Communications Technology (Shenzhen) Co., Ltd

Room B37, Warehouse A5, No.3 Chiwan 4th Road, Zhaoshang Street, Nanshan District Shenzhen, Guangdong, People's Republic of China

Tel: +86 755 8869 6566 Fax: +86 755 8869 6577

Email: customerservice.sw@bureauveritas.com



BUREAU VERITAS

Test Report No.: W7L-P23120015R102

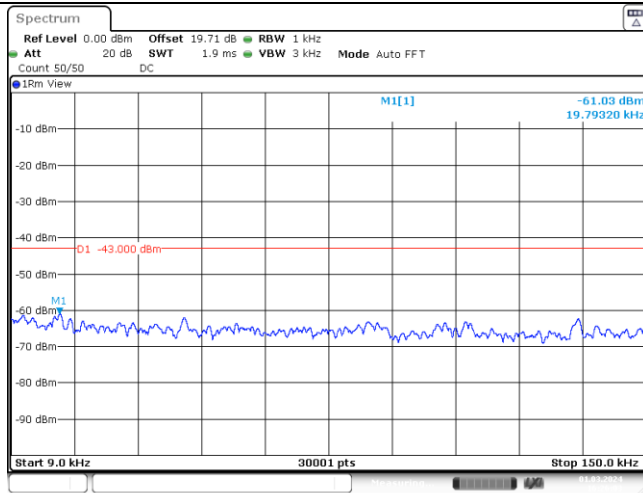

Band2-1.4MHz-QPSK-18900-1-0-Low-0.009-0.15--61.03-PASS

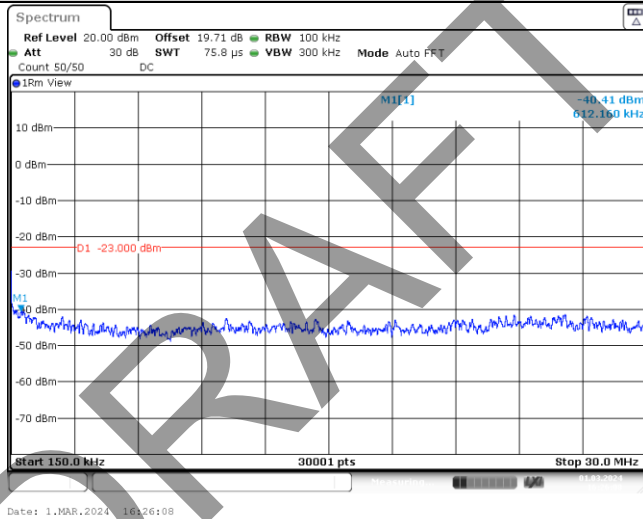

Band2-1.4MHz-QPSK-18900-1-0-Low-0.15-30--40.41-PASS

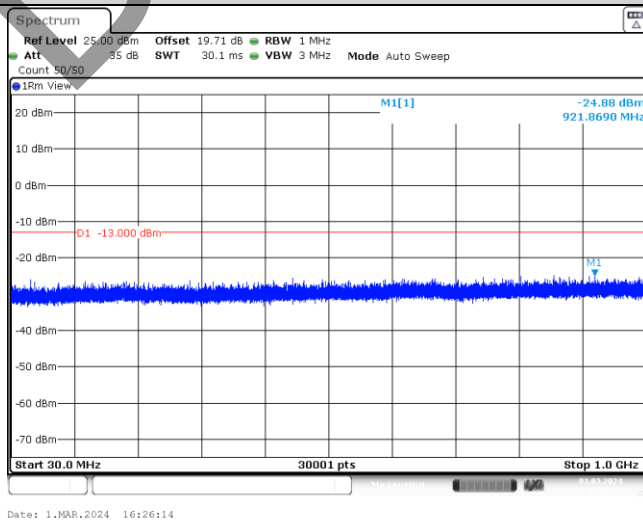

Band2-1.4MHz-QPSK-18900-1-0-Low-30-1000--24.88-PASS

BV 7Layers Communications Technology (Shenzhen) Co., Ltd

Room B37, Warehouse A5, No.3 Chiwan 4th Road, Zhaoshang Street, Nanshan District Shenzhen, Guangdong, People's Republic of China

Tel: +86 755 8869 6566
 Fax: +86 755 8869 6577
 Email: customerservice.sw@bureauveritas.com



BUREAU VERITAS

Test Report No.: W7L-P23120015R102

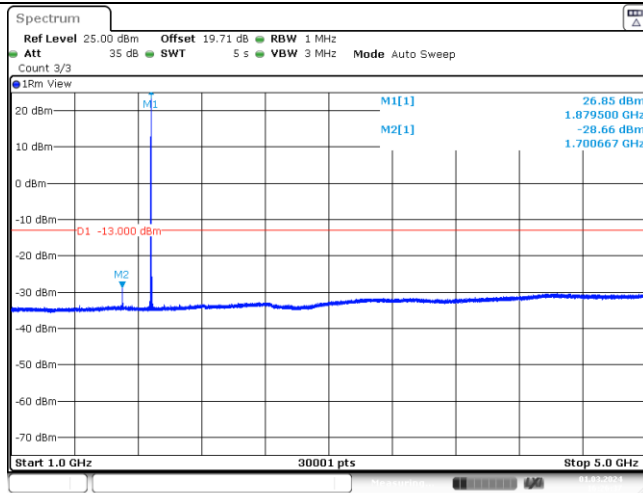

Band2-1.4MHz-QPSK-18900-1-0-Low-1000-5000--28.66-PASS

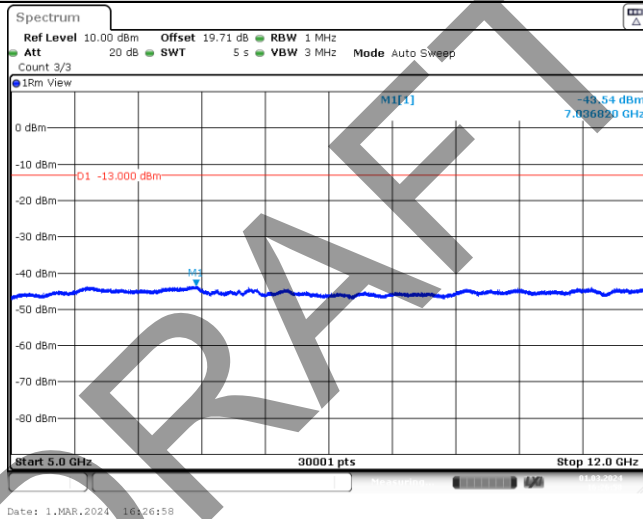

Band2-1.4MHz-QPSK-18900-1-0-Low-5000-12000--43.54-PASS

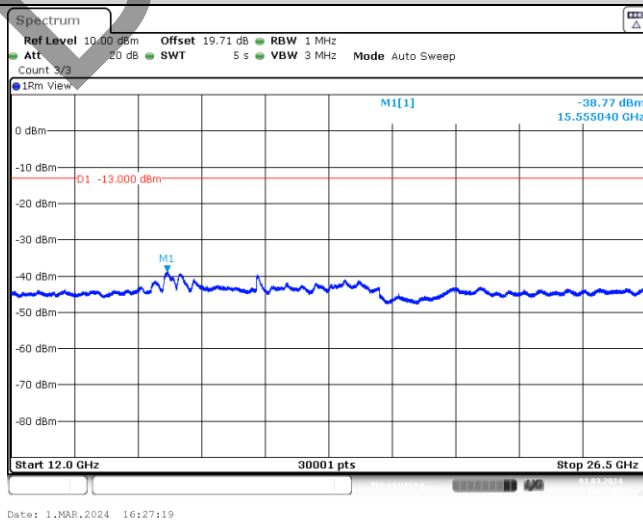

Band2-1.4MHz-QPSK-18900-1-0-Low-12000-26500--38.77-PASS

BV 7Layers Communications Technology (Shenzhen) Co., Ltd

Room B37, Warehouse A5, No.3 Chiwan 4th Road, Zhaoshang Street, Nanshan District Shenzhen, Guangdong, People's Republic of China

Tel: +86 755 8869 6566 Fax: +86 755 8869 6577

Email: customerservice.sw@bureauveritas.com



BUREAU VERITAS

Test Report No.: W7L-P23120015R102

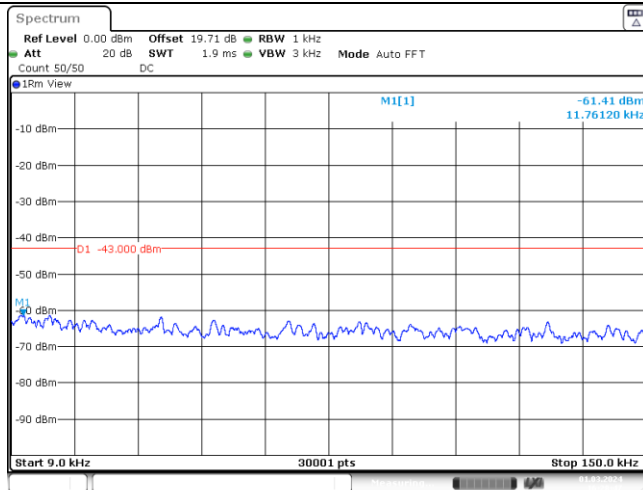

Date: 1.MAR.2024 16:28:47

Band2-1.4MHz-QPSK-19193-1-0-High-0.009-0.15--61.41-PASS

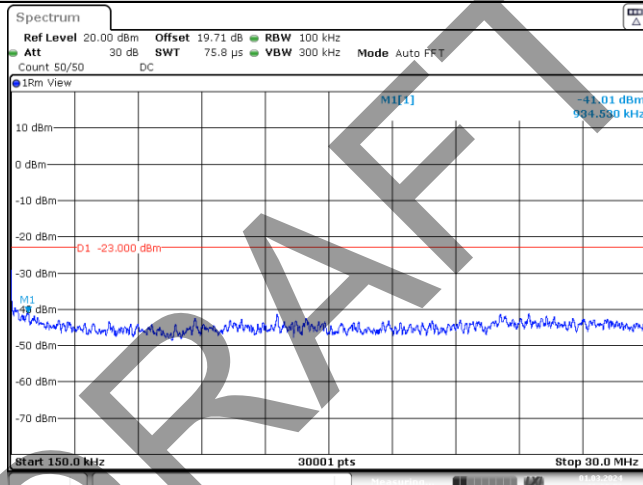

Date: 1.MAR.2024 16:28:52

Band2-1.4MHz-QPSK-19193-1-0-High-0.15-30--41.01-PASS

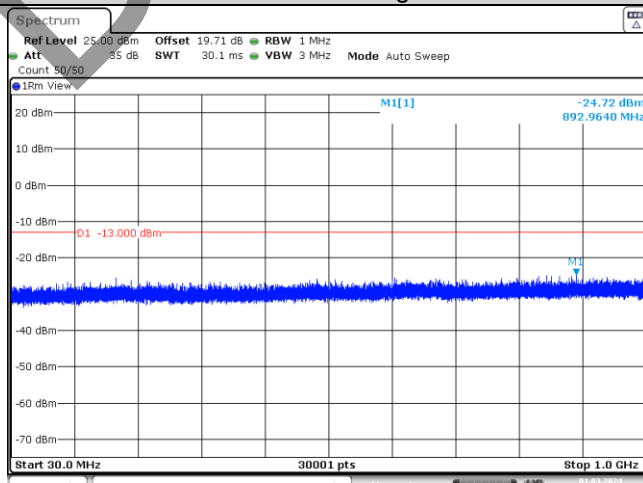

Date: 1.MAR.2024 16:28:58

Band2-1.4MHz-QPSK-19193-1-0-High-30-1000--24.72-PASS

BV 7Layers Communications Technology (Shenzhen) Co., Ltd

Room B37, Warehouse A5, No.3 Chiwan 4th Road, Zhaoshang Street, Nanshan District Shenzhen, Guangdong, People's Republic of China

Tel: +86 755 8869 6566 Fax: +86 755 8869 6577

Email: customerservice.sw@bureauveritas.com



BUREAU VERITAS

Test Report No.: W7L-P23120015R102

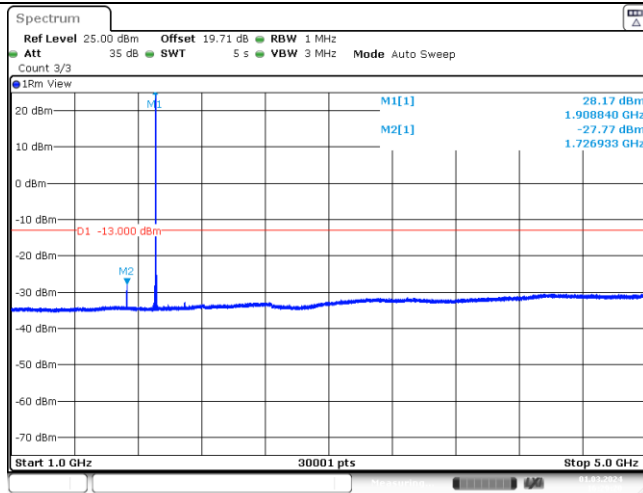

Date: 1.MAR.2024 16:29:20

Band2-1.4MHz-QPSK-19193-1-0-High-1000-5000--27.77-PASS

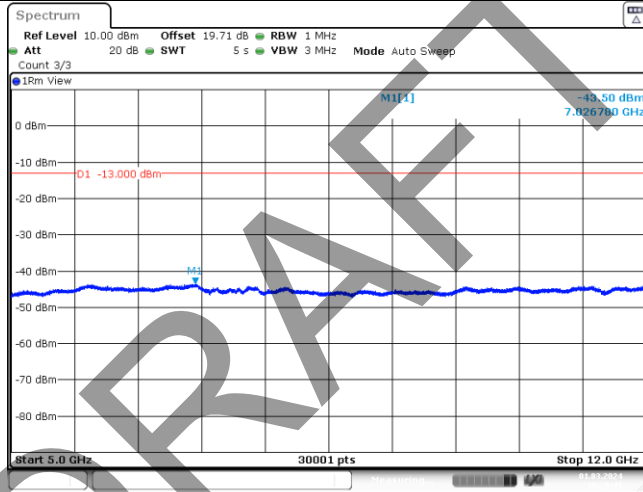

Date: 1.MAR.2024 16:29:42

Band2-1.4MHz-QPSK-19193-1-0-High-5000-12000--43.5-PASS

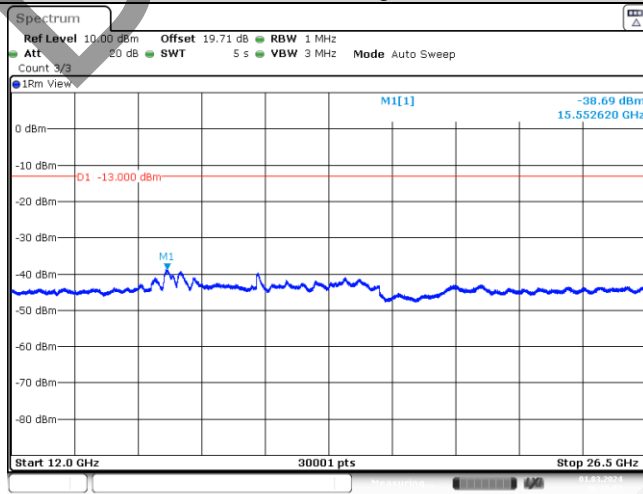

Date: 1.MAR.2024 16:30:03

Band2-1.4MHz-QPSK-19193-1-0-High-12000-26500--38.69-PASS

BV 7Layers Communications Technology (Shenzhen) Co., Ltd

Room B37, Warehouse A5, No.3 Chiwan 4th Road, Zhaoshang Street, Nanshan District Shenzhen, Guangdong, People's Republic of China

Tel: +86 755 8869 6566
Fax: +86 755 8869 6577
Email: customerservice.sw@bureauveritas.com



BUREAU VERITAS

Test Report No.: W7L-P23120015R102

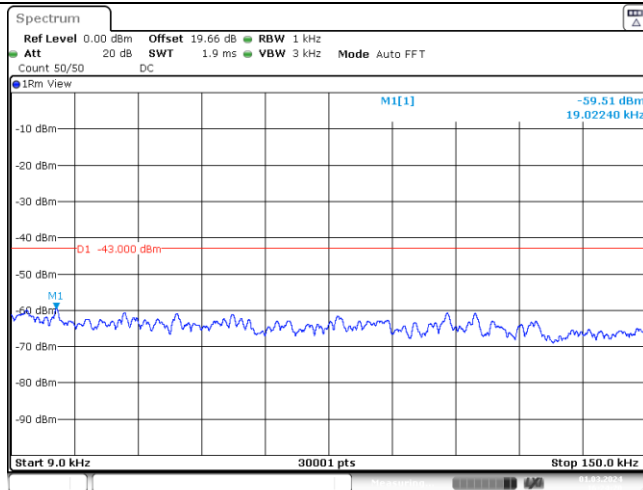

Date: 1.MAR.2024 16:24:20

Band2-1.4MHz-16QAM-18607-1-0-Low-0.15--59.51-PASS

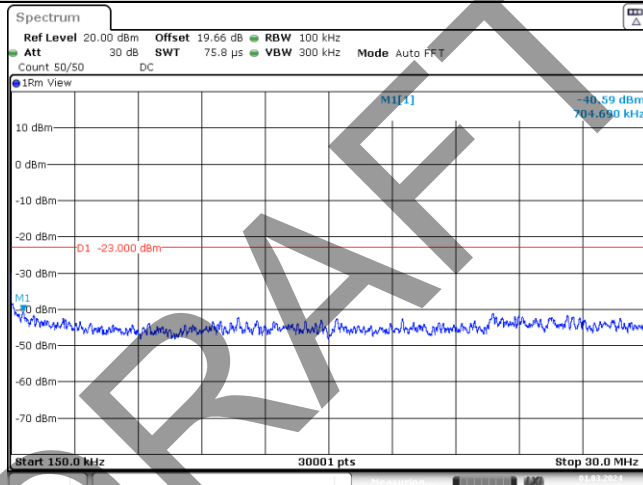

Date: 1.MAR.2024 16:24:25

Band2-1.4MHz-16QAM-18607-1-0-Low-0.15-30--40.59-PASS

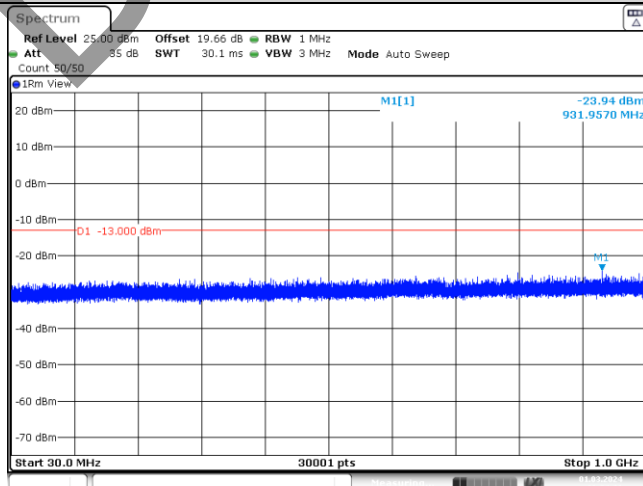

Date: 1.MAR.2024 16:24:31

Band2-1.4MHz-16QAM-18607-1-0-Low-30-1000--23.94-PASS

BV 7Layers Communications Technology (Shenzhen) Co., Ltd

Room B37, Warehouse A5, No.3 Chiwan 4th Road, Zhaoshang Street, Nanshan District Shenzhen, Guangdong, People's Republic of China

Tel: +86 755 8869 6566 Fax: +86 755 8869 6577

Email: customerservice.sw@bureauveritas.com



BUREAU VERITAS

Test Report No.: W7L-P23120015R102

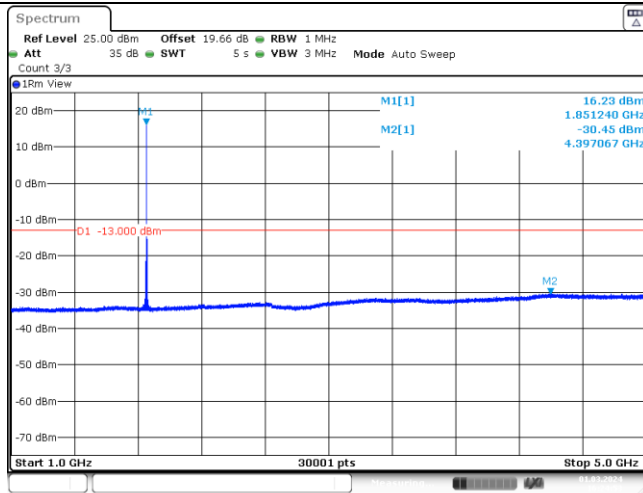

Band2-1.4MHz-16QAM-18607-1-0-Low-1000-5000--30.45-PASS

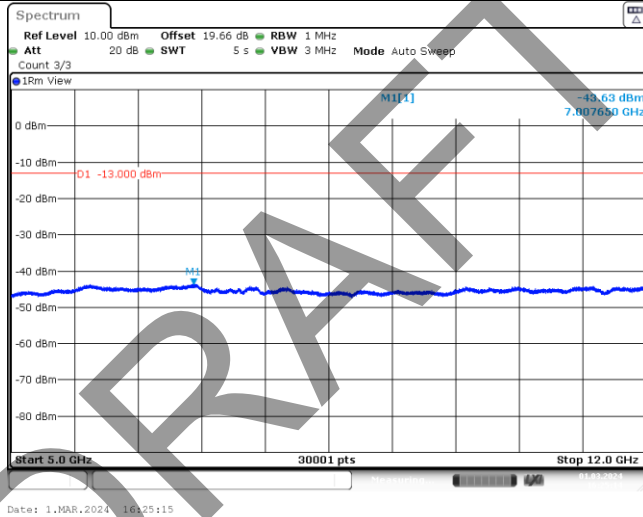

Band2-1.4MHz-16QAM-18607-1-0-Low-5000-12000--43.63-PASS

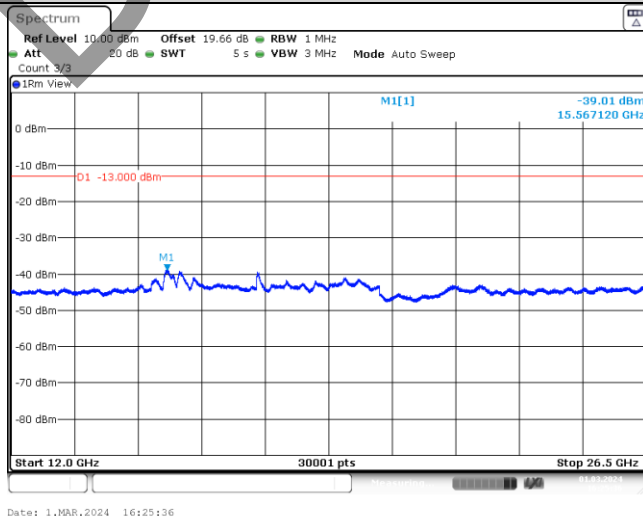

Band2-1.4MHz-16QAM-18607-1-0-Low-12000-26500--39.01-PASS



BUREAU VERITAS

Test Report No.: W7L-P23120015R102

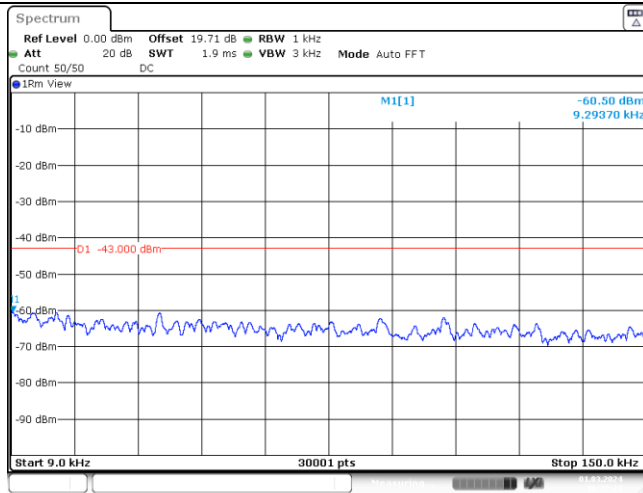

Date: 1.MAR.2024 16:27:24

Band2-1.4MHz-16QAM-18900-1-0-Low-0.009-0.15--60.5-PASS

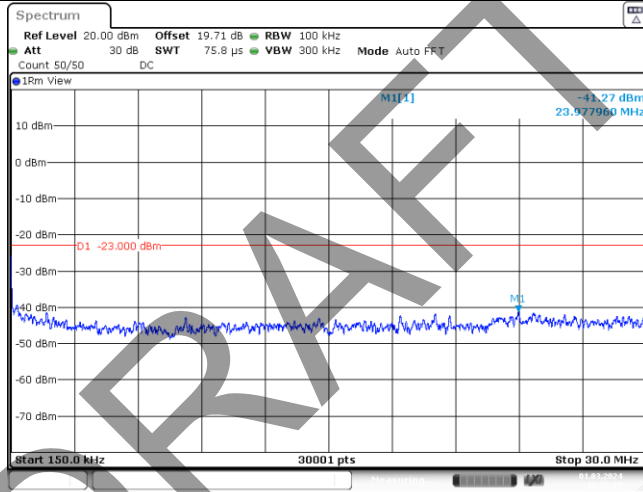

Date: 1.MAR.2024 16:27:29

Band2-1.4MHz-16QAM-18900-1-0-Low-0.15-30--41.27-PASS

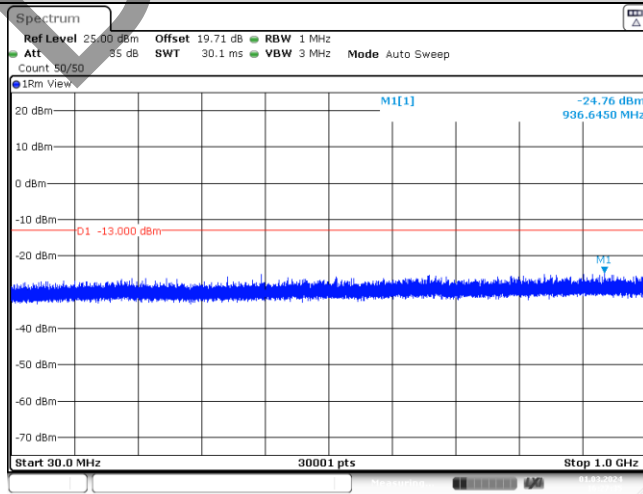

Date: 1.MAR.2024 16:27:35

Band2-1.4MHz-16QAM-18900-1-0-Low-30-1000--24.76-PASS

BV 7Layers Communications Technology (Shenzhen) Co., Ltd

Room B37, Warehouse A5, No.3 Chiwan 4th Road, Zhaoshang Street, Nanshan District Shenzhen, Guangdong, People's Republic of China

Tel: +86 755 8869 6566 Fax: +86 755 8869 6577

Email: customerservice.sw@bureauveritas.com



BUREAU VERITAS

Test Report No.: W7L-P23120015R102

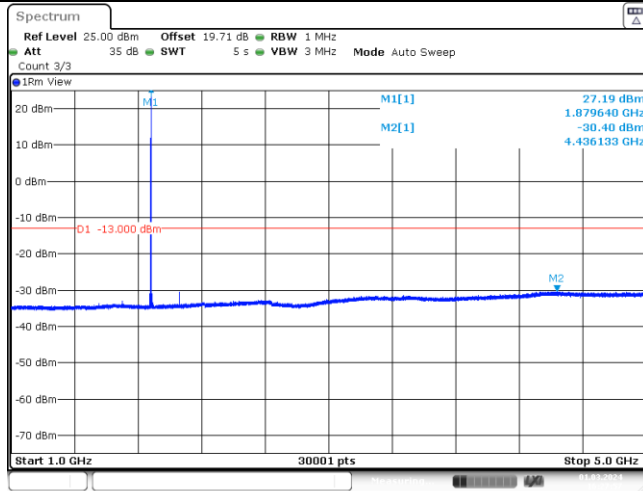

Band2-1.4MHz-16QAM-18900-1-0-Low-1000-5000--30.4-PASS

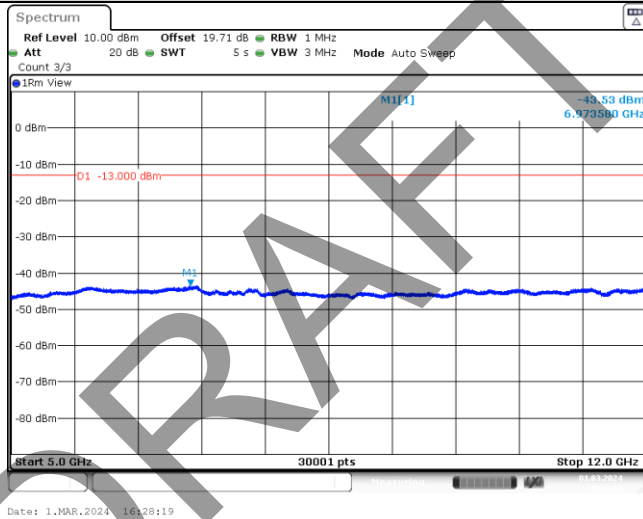

Band2-1.4MHz-16QAM-18900-1-0-Low-5000-12000--43.53-PASS

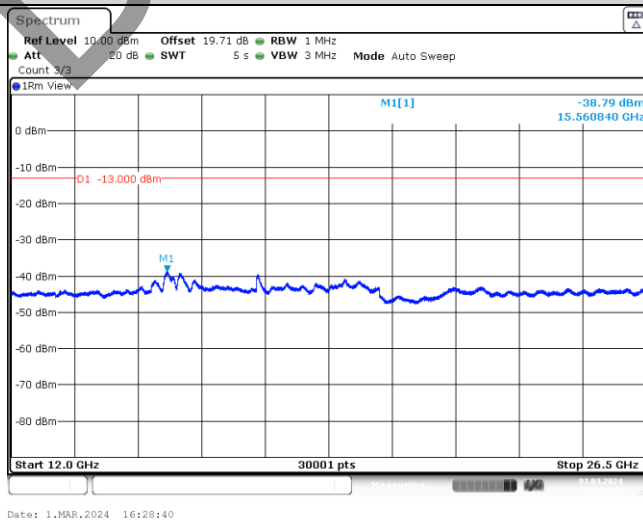

Band2-1.4MHz-16QAM-18900-1-0-Low-12000-26500--38.79-PASS

BV 7Layers Communications Technology (Shenzhen) Co., Ltd

Room B37, Warehouse A5, No.3 Chiwan 4th Road, Zhaoshang Street, Nanshan District Shenzhen, Guangdong, People's Republic of China

Tel: +86 755 8869 6566 Fax: +86 755 8869 6577

Email: customerservice.sw@bureauveritas.com



BUREAU VERITAS

Test Report No.: W7L-P23120015R102

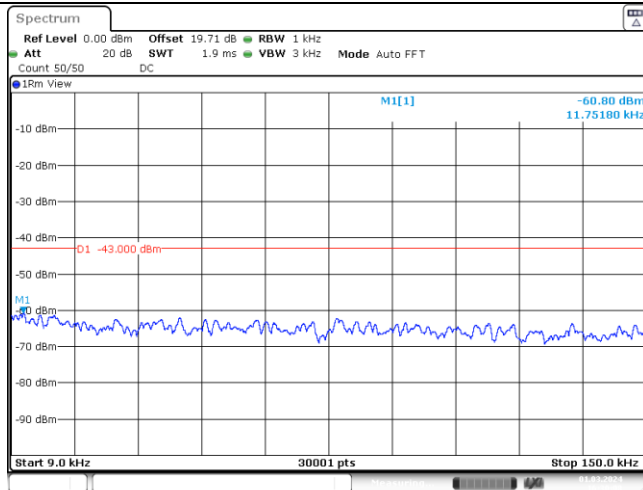

Date: 1.MAR.2024 16:30:08

Band2-1.4MHz-16QAM-19193-1-0-High-0.009-0.15--60.8-PASS

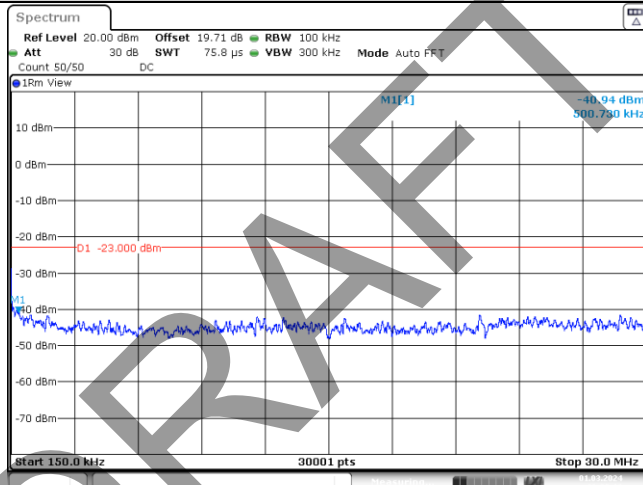

Date: 1.MAR.2024 16:30:12

Band2-1.4MHz-16QAM-19193-1-0-High-0.15-30--40.94-PASS

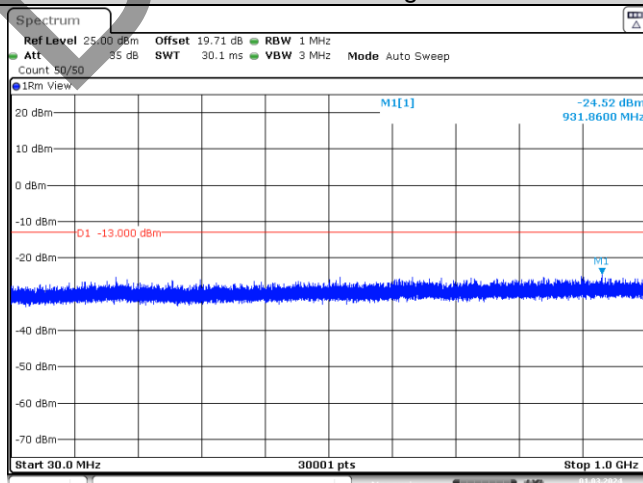

Date: 1.MAR.2024 16:30:19

Band2-1.4MHz-16QAM-19193-1-0-High-30-1000--24.52-PASS

BV 7Layers Communications Technology (Shenzhen) Co., Ltd

Room B37, Warehouse A5, No.3 Chiwan 4th Road, Zhaoshang Street, Nanshan District Shenzhen, Guangdong, People's Republic of China

Tel: +86 755 8869 6566 Fax: +86 755 8869 6577

Email: customerservice.sw@bureauveritas.com



BUREAU VERITAS

Test Report No.: W7L-P23120015R102

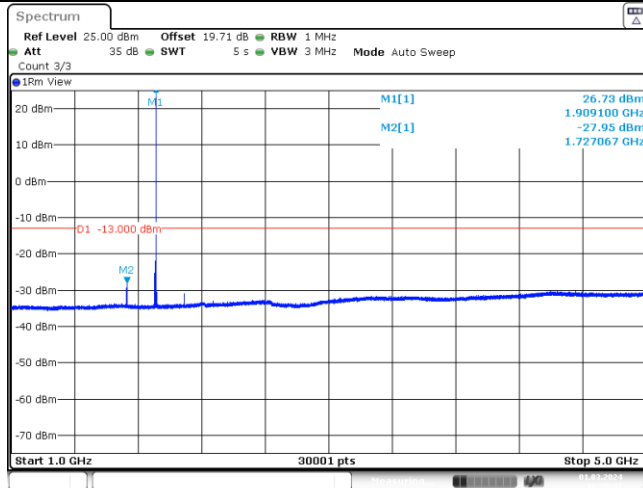

Date: 1.MAR.2024 16:30:41

Band2-1.4MHz-16QAM-19193-1-0-High-1000-5000--27.95-PASS

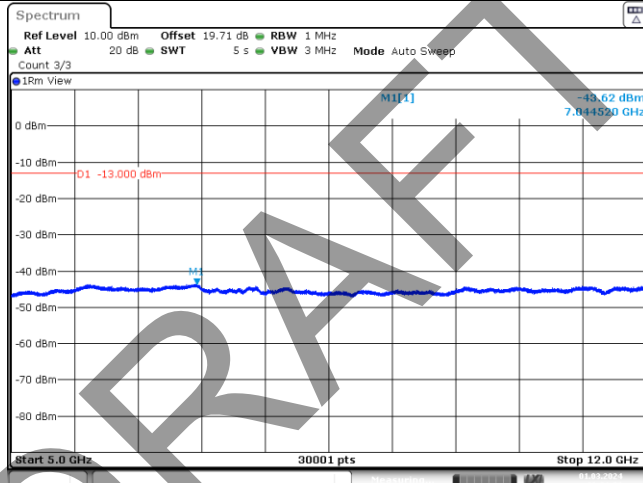

Date: 1.MAR.2024 16:31:02

Band2-1.4MHz-16QAM-19193-1-0-High-5000-12000--43.62-PASS

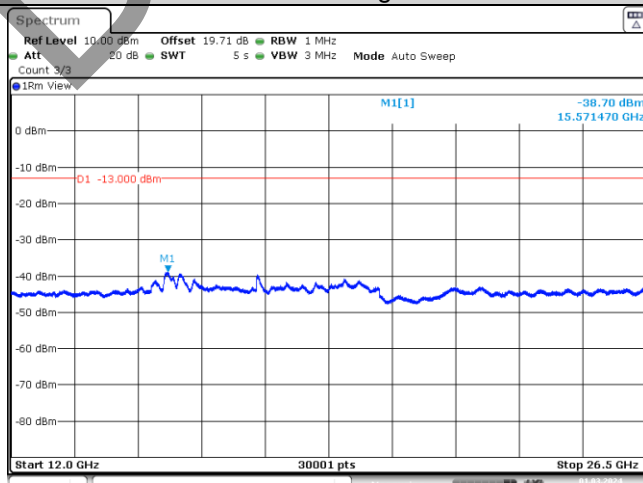

Date: 1.MAR.2024 16:31:24

Band2-1.4MHz-16QAM-19193-1-0-High-12000-26500--38.7-PASS

BV 7Layers Communications Technology (Shenzhen) Co., Ltd

Room B37, Warehouse A5, No.3 Chiwan 4th Road, Zhaoshang Street, Nanshan District Shenzhen, Guangdong, People's Republic of China

Tel: +86 755 8869 6566 Fax: +86 755 8869 6577

Email: customerservice.sw@bureauveritas.com



BUREAU VERITAS

Test Report No.: W7L-P23120015R102

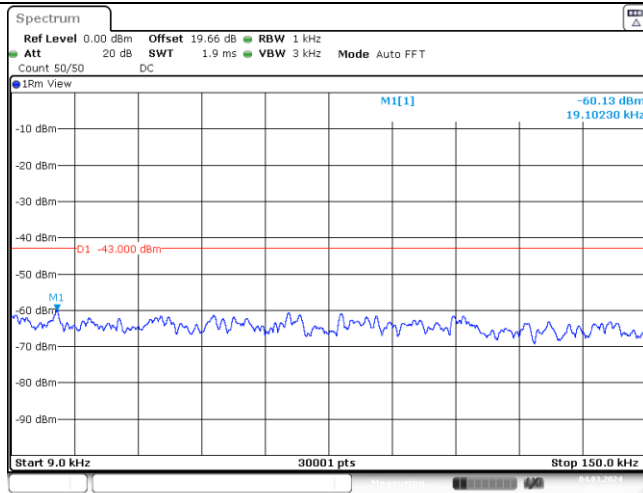

Band2-3MHz-QPSK-18615-1-0-Low-0.009-0.15--60.13-PASS

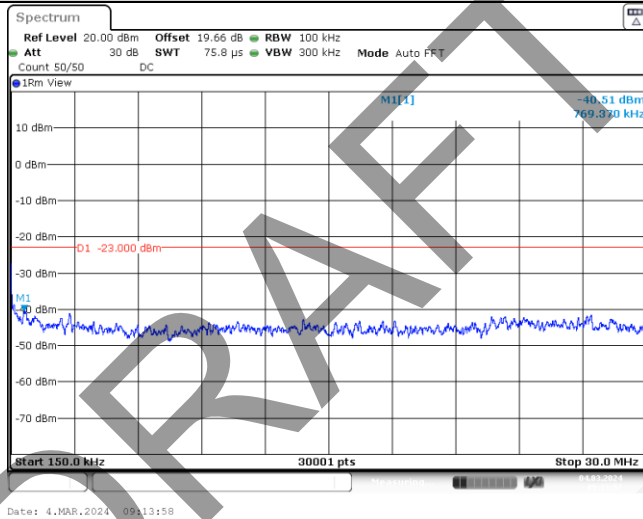

Band2-3MHz-QPSK-18615-1-0-Low-0.15-30--40.51-PASS

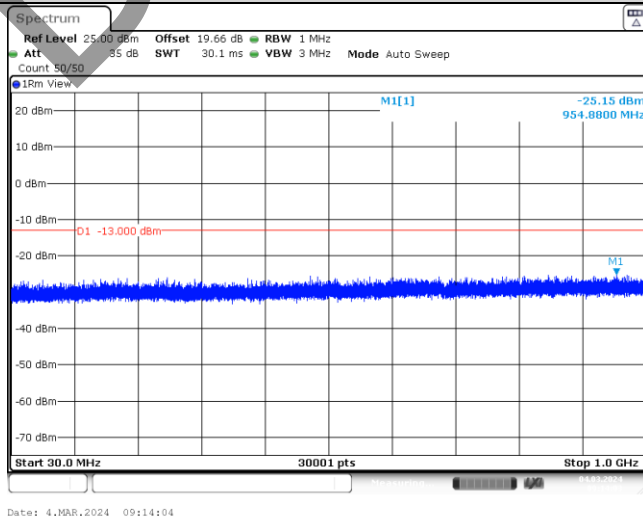

Band2-3MHz-QPSK-18615-1-0-Low-30-1000--25.15-PASS



BUREAU VERITAS

Test Report No.: W7L-P23120015R102

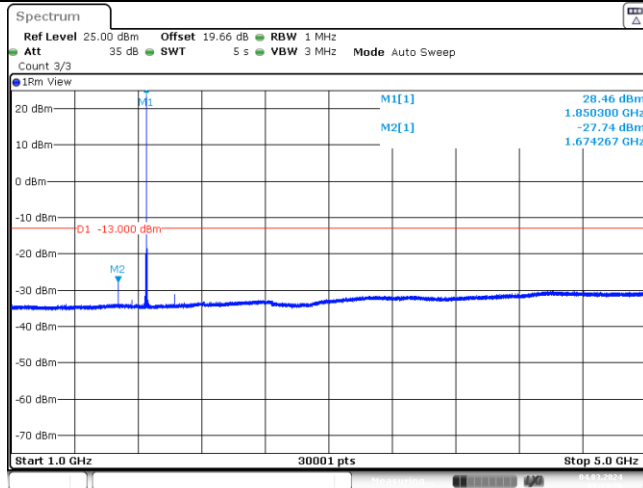

Date: 4.MAR.2024 09:14:26

Band2-3MHz-QPSK-18615-1-0-Low-1000-5000--27.74-PASS

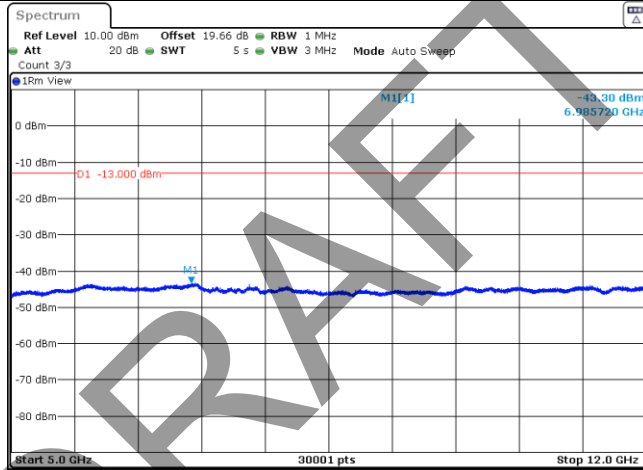

Date: 4.MAR.2024 09:14:47

Band2-3MHz-QPSK-18615-1-0-Low-5000-12000--43.3-PASS

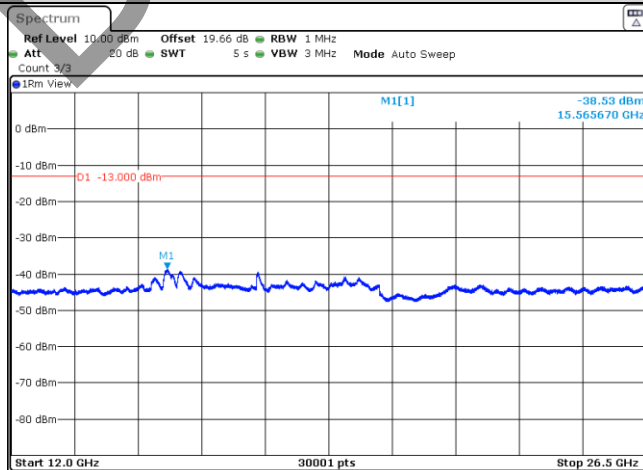

Date: 4.MAR.2024 09:15:09

Band2-3MHz-QPSK-18615-1-0-Low-12000-26500--38.53-PASS

BV 7Layers Communications Technology (Shenzhen) Co., Ltd

Room B37, Warehouse A5, No.3 Chiwan 4th Road, Zhaoshang Street, Nanshan District Shenzhen, Guangdong, People's Republic of China

Tel: +86 755 8869 6566 Fax: +86 755 8869 6577

Email: customerservice.sw@bureauveritas.com



BUREAU VERITAS

Test Report No.: W7L-P23120015R102

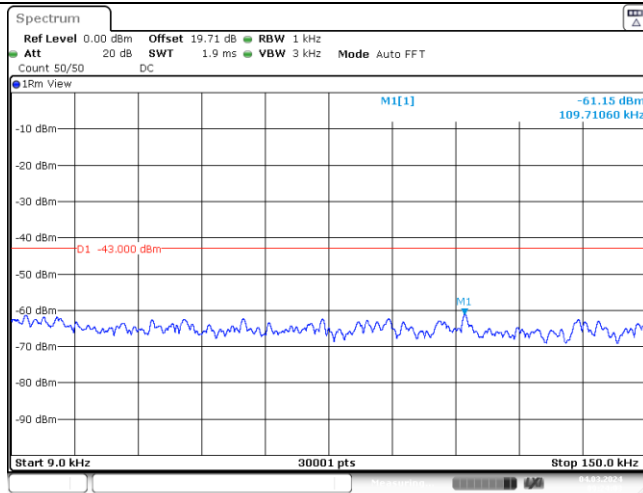

Band2-3MHz-QPSK-18900-1-0-Low-0.009-0.15--61.15-PASS

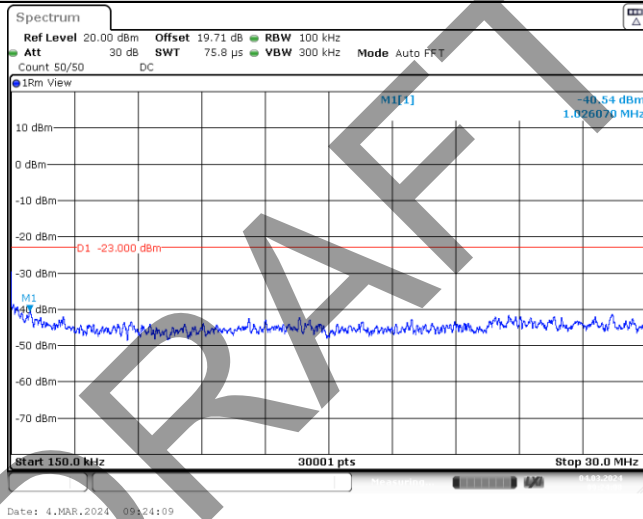

Band2-3MHz-QPSK-18900-1-0-Low-0.15-30--40.54-PASS

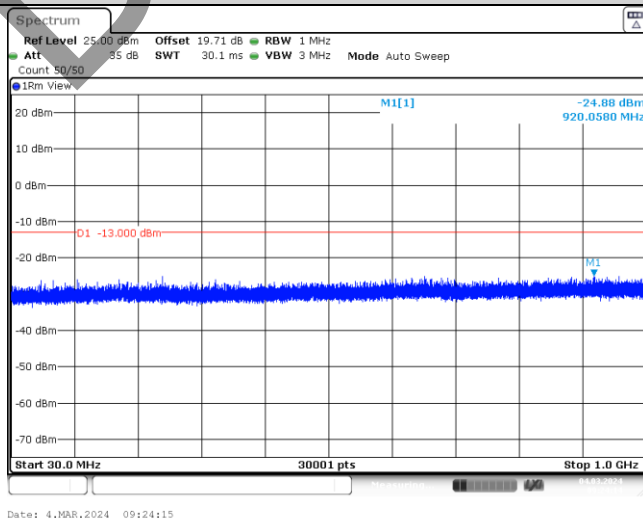

Band2-3MHz-QPSK-18900-1-0-Low-30-1000--24.88-PASS

BV 7Layers Communications Technology (Shenzhen) Co., Ltd

Room B37, Warehouse A5, No.3 Chiwan 4th Road, Zhaoshang Street, Nanshan District Shenzhen, Guangdong, People's Republic of China

Tel: +86 755 8869 6566 Fax: +86 755 8869 6577

Email: customerservice.sw@bureauveritas.com



BUREAU VERITAS

Test Report No.: W7L-P23120015R102

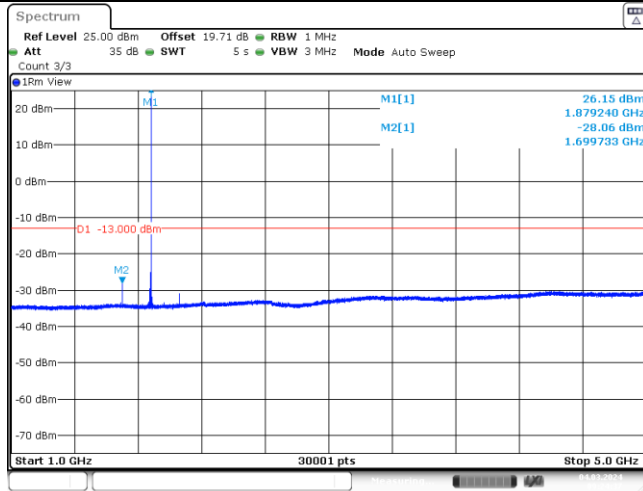

Date: 4.MAR.2024 09:24:37

Band2-3MHz-QPSK-18900-1-0-Low-1000-5000--28.06-PASS

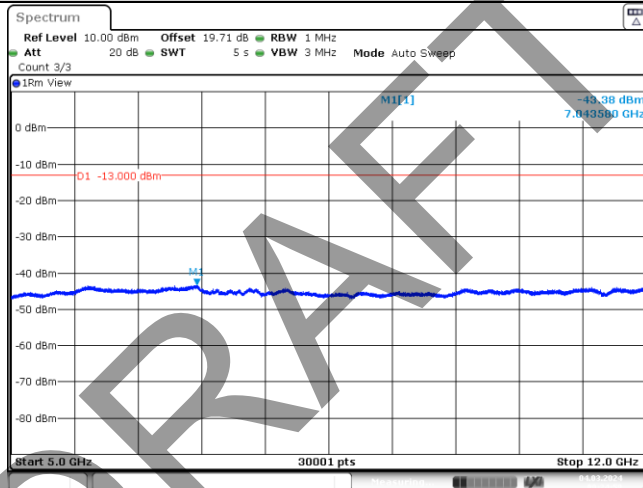

Date: 4.MAR.2024 09:24:58

Band2-3MHz-QPSK-18900-1-0-Low-5000-12000--43.38-PASS

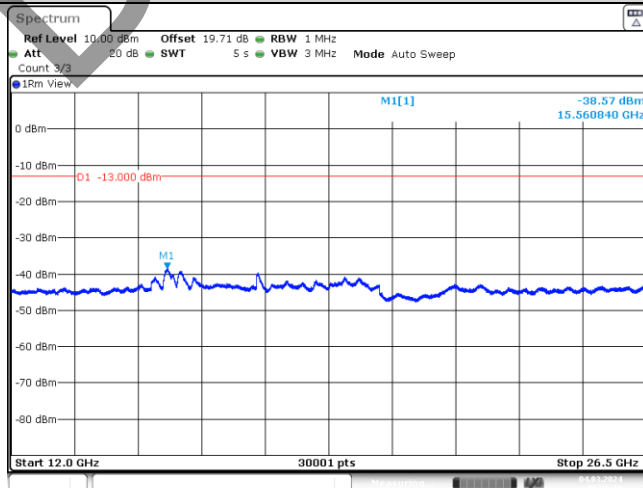

Date: 4.MAR.2024 09:25:19

Band2-3MHz-QPSK-18900-1-0-Low-12000-26500--38.57-PASS

BV 7Layers Communications Technology (Shenzhen) Co., Ltd

Room B37, Warehouse A5, No.3 Chiwan 4th Road, Zhaoshang Street, Nanshan District Shenzhen, Guangdong, People's Republic of China

Tel: +86 755 8869 6566 Fax: +86 755 8869 6577

Email: customerservice.sw@bureauveritas.com



BUREAU VERITAS

Test Report No.: W7L-P23120015R102

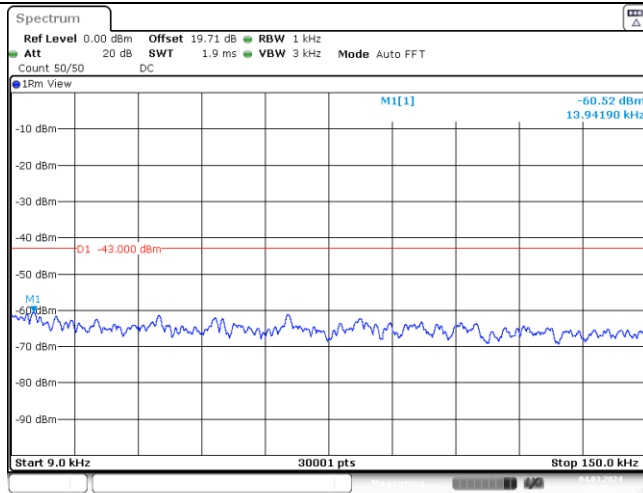

Band2-3MHz-QPSK-19185-1-0-High-0.009-0.15--60.52-PASS

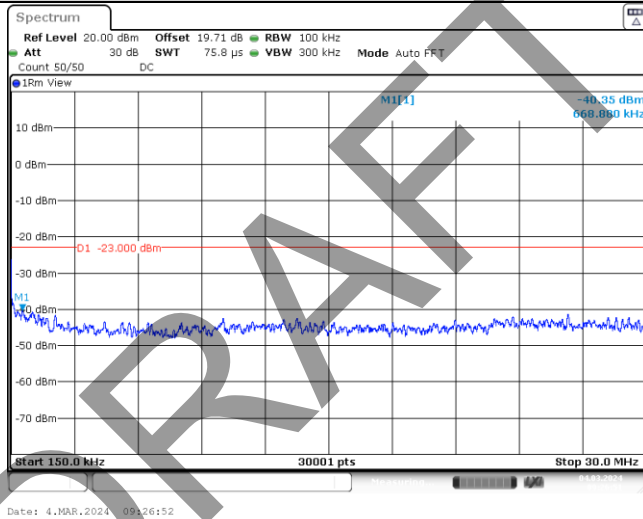

Band2-3MHz-QPSK-19185-1-0-High-0.15-30--40.35-PASS

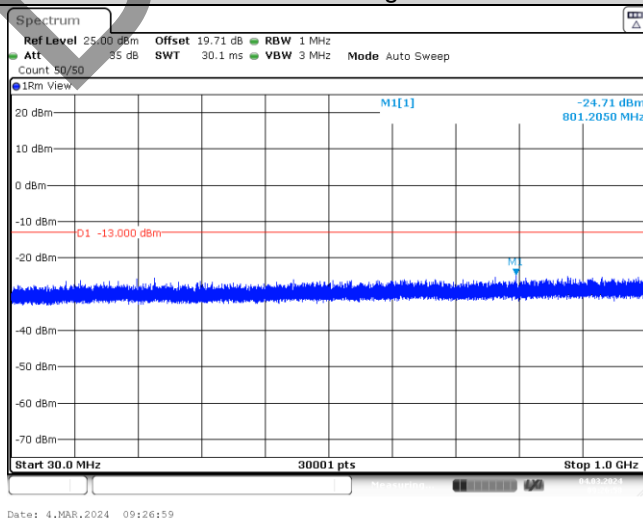

Band2-3MHz-QPSK-19185-1-0-High-30-1000--24.71-PASS

BV 7Layers Communications Technology (Shenzhen) Co., Ltd

Room B37, Warehouse A5, No.3 Chiwan 4th Road, Zhaoshang Street, Nanshan District Shenzhen, Guangdong, People's Republic of China

Tel: +86 755 8869 6566 Fax: +86 755 8869 6577

Email: customerservice.sw@bureauveritas.com



BUREAU VERITAS

Test Report No.: W7L-P23120015R102

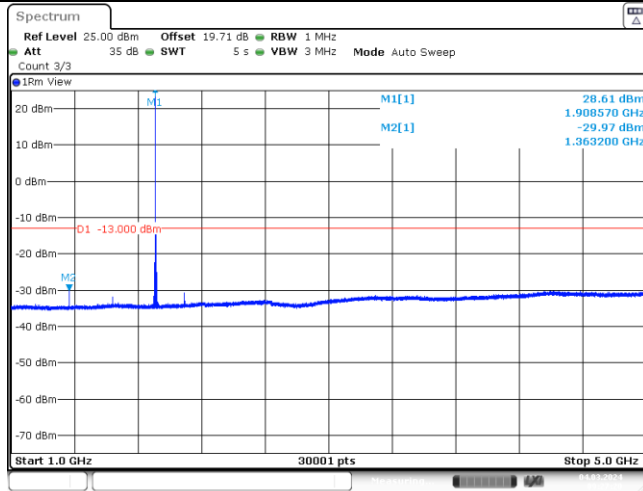

Date: 4.MAR.2024 09:27:21

Band2-3MHz-QPSK-19185-1-0-High-1000-5000--29.97-PASS

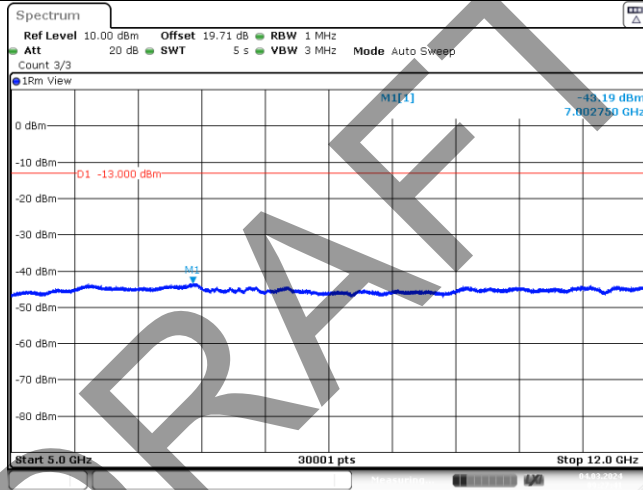

Date: 4.MAR.2024 09:27:42

Band2-3MHz-QPSK-19185-1-0-High-5000-12000--43.19-PASS

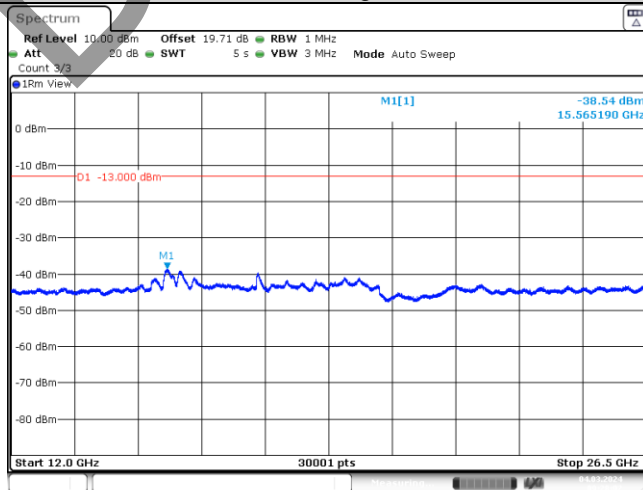

Date: 4.MAR.2024 09:28:03

Band2-3MHz-QPSK-19185-1-0-High-12000-26500--38.54-PASS

BV 7Layers Communications Technology (Shenzhen) Co., Ltd

Room B37, Warehouse A5, No.3 Chiwan 4th Road, Zhaoshang Street, Nanshan District Shenzhen, Guangdong, People's Republic of China

Tel: +86 755 8869 6566 Fax: +86 755 8869 6577

Email: customerservice.sw@bureauveritas.com



BUREAU VERITAS

Test Report No.: W7L-P23120015R102

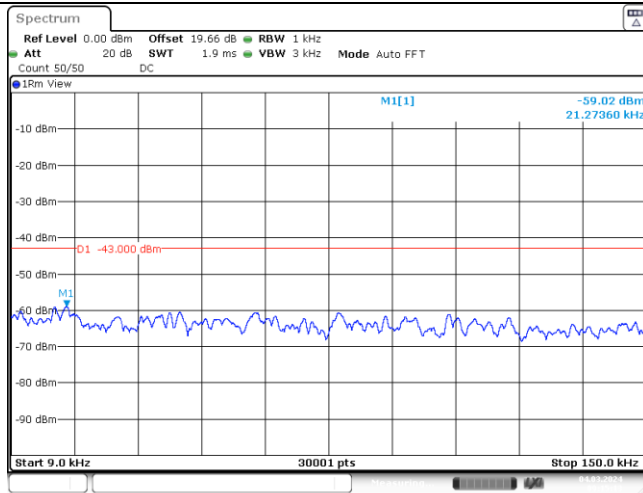

Band2-3MHz-16QAM-18615-1-0-Low-0.15--59.02-PASS

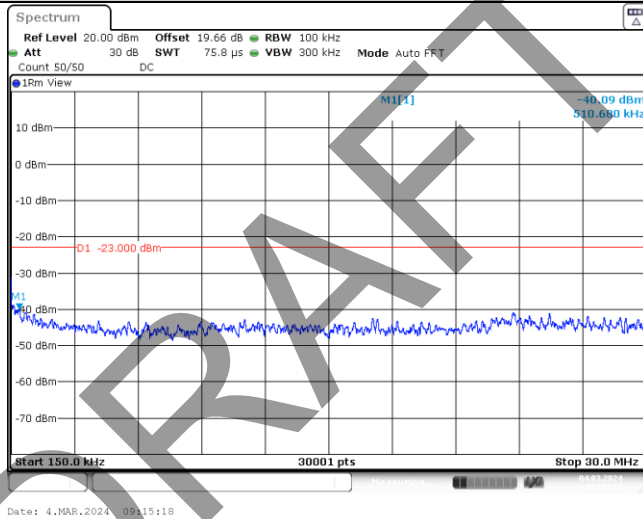

Band2-3MHz-16QAM-18615-1-0-Low-0.15-30--40.09-PASS

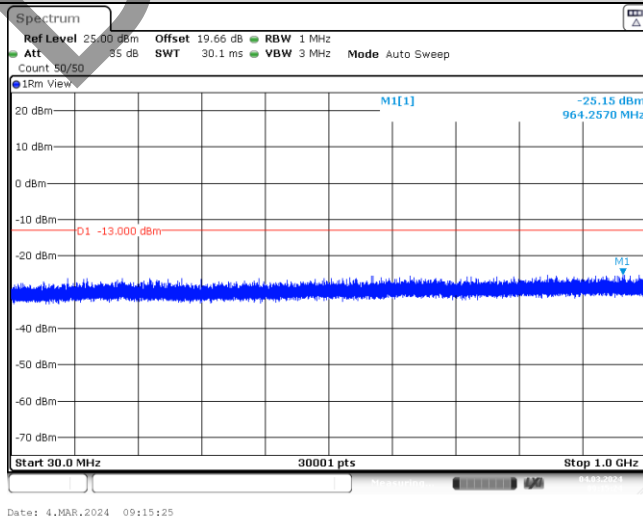

Band2-3MHz-16QAM-18615-1-0-Low-30-1000--25.15-PASS

BV 7Layers Communications Technology (Shenzhen) Co., Ltd

Room B37, Warehouse A5, No.3 Chiwan 4th Road, Zhaoshang Street, Nanshan District Shenzhen, Guangdong, People's Republic of China

Tel: +86 755 8869 6566 Fax: +86 755 8869 6577

Email: customerservice.sw@bureauveritas.com



BUREAU VERITAS

Test Report No.: W7L-P23120015R102

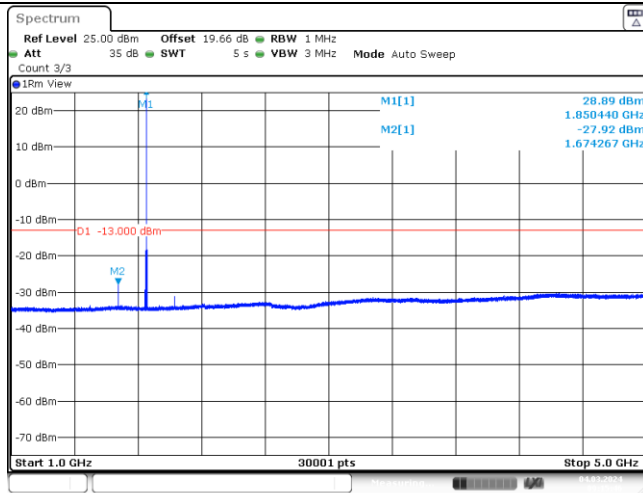

Date: 4.MAR.2024 09:15:47

Band2-3MHz-16QAM-18615-1-0-Low-1000-5000--27.92-PASS

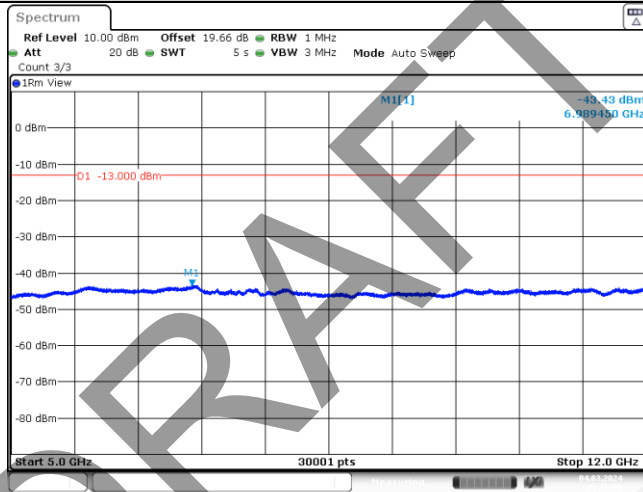

Date: 4.MAR.2024 09:16:08

Band2-3MHz-16QAM-18615-1-0-Low-5000-12000--43.43-PASS

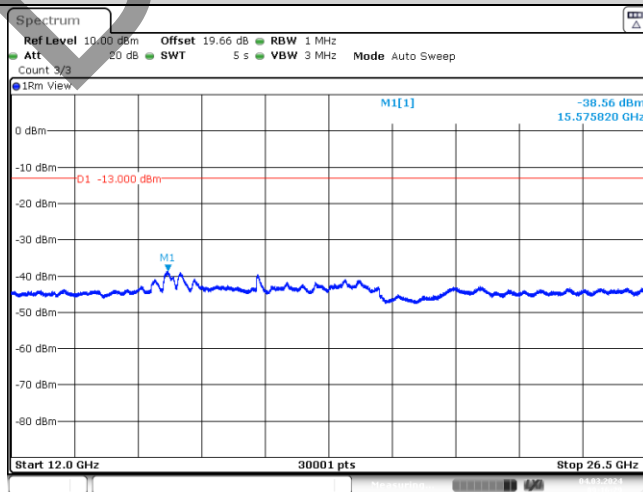

Date: 4.MAR.2024 09:16:29

Band2-3MHz-16QAM-18615-1-0-Low-12000-26500--38.56-PASS

BV 7Layers Communications Technology (Shenzhen) Co., Ltd

Room B37, Warehouse A5, No.3 Chiwan 4th Road, Zhaoshang Street, Nanshan District Shenzhen, Guangdong, People's Republic of China

Tel: +86 755 8869 6566 Fax: +86 755 8869 6577 Email: customerservice.sw@bureauveritas.com



BUREAU VERITAS

Test Report No.: W7L-P23120015R102

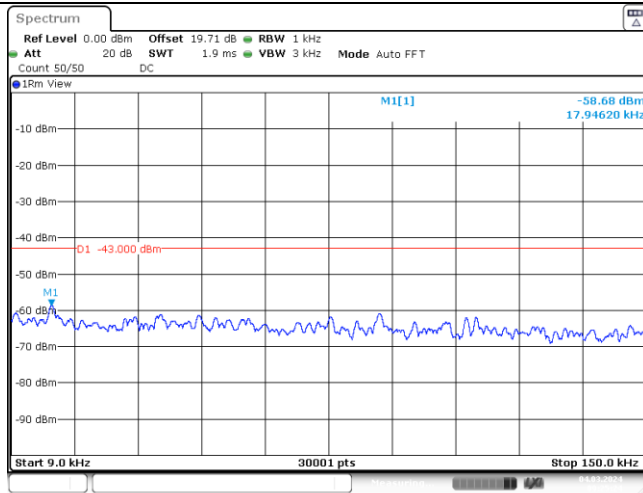

Date: 4.MAR.2024 09:25:25

Band2-3MHz-16QAM-18900-1-0-Low-0.009-0.15--58.68-PASS

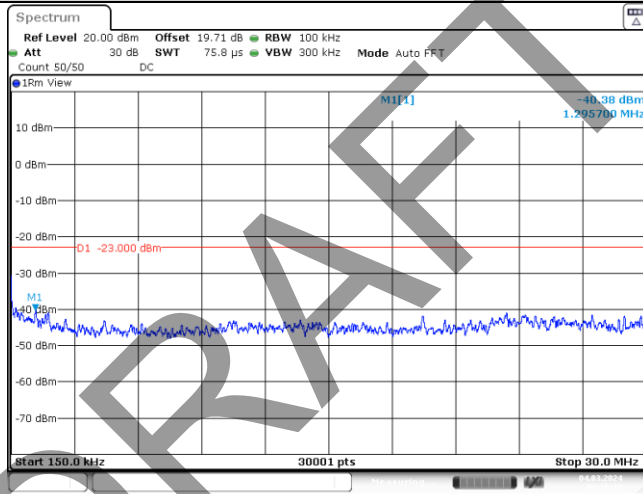

Date: 4.MAR.2024 09:25:29

Band2-3MHz-16QAM-18900-1-0-Low-0.15-30--40.38-PASS

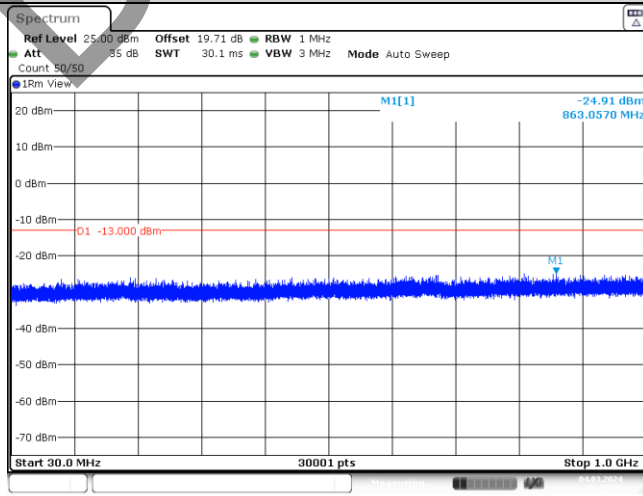

Date: 4.MAR.2024 09:25:36

Band2-3MHz-16QAM-18900-1-0-Low-30-1000--24.91-PASS

BV 7Layers Communications Technology (Shenzhen) Co., Ltd

Room B37, Warehouse A5, No.3 Chiwan 4th Road, Zhaoshang Street, Nanshan District Shenzhen, Guangdong, People's Republic of China

Tel: +86 755 8869 6566 Fax: +86 755 8869 6577

Email: customerservice.sw@bureauveritas.com



BUREAU VERITAS

Test Report No.: W7L-P23120015R102

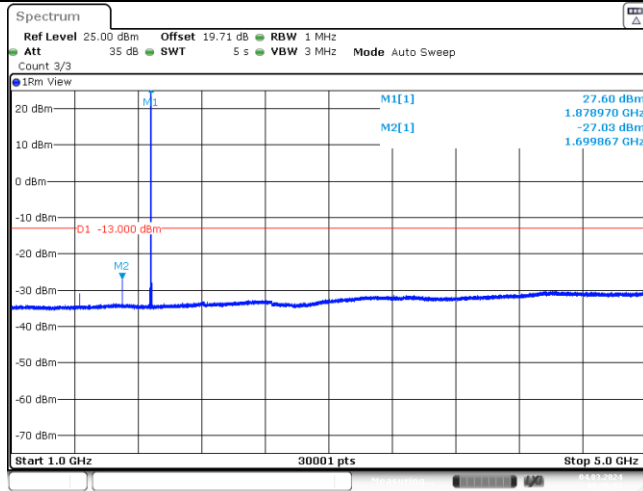

Band2-3MHz-16QAM-18900-1-0-Low-1000-5000--27.03-PASS

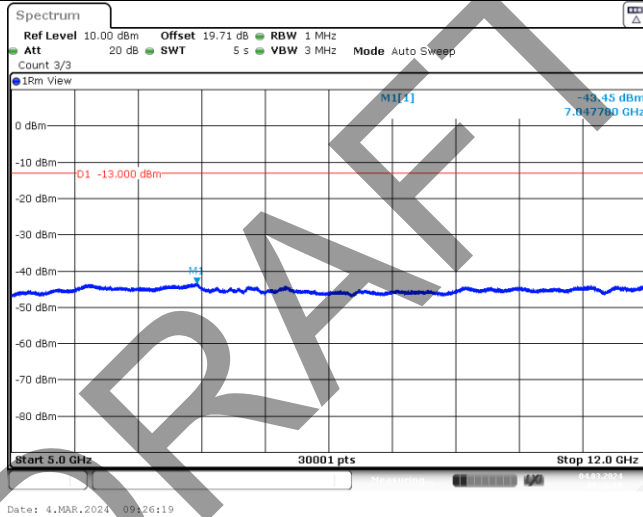

Band2-3MHz-16QAM-18900-1-0-Low-5000-12000--43.45-PASS

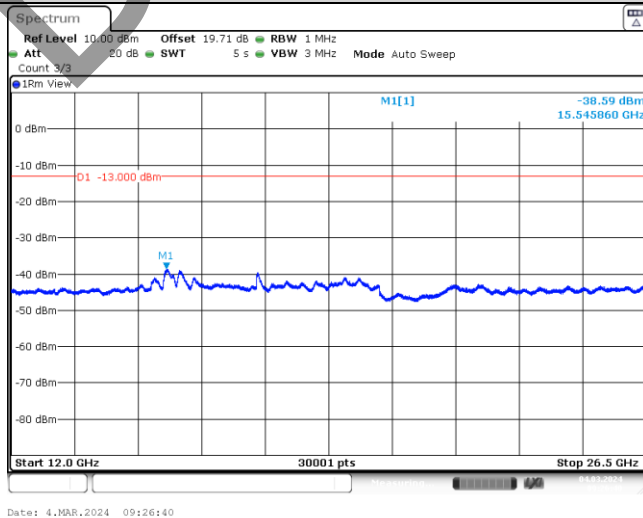

Band2-3MHz-16QAM-18900-1-0-Low-12000-26500--38.59-PASS

BV 7Layers Communications Technology (Shenzhen) Co., Ltd

Room B37, Warehouse A5, No.3 Chiwan 4th Road, Zhaoshang Street, Nanshan District Shenzhen, Guangdong, People's Republic of China

Tel: +86 755 8869 6566 Fax: +86 755 8869 6577 Email: customerservice.sw@bureauveritas.com



BUREAU VERITAS

Test Report No.: W7L-P23120015R102

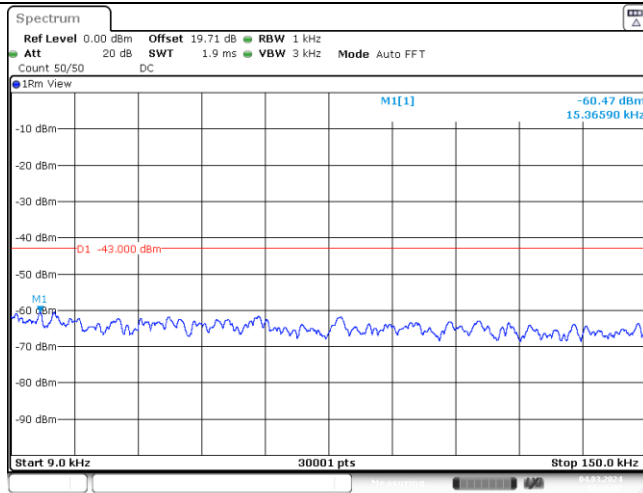

Band2-3MHz-16QAM-19185-1-0-High-0.009-0.15--60.47-PASS

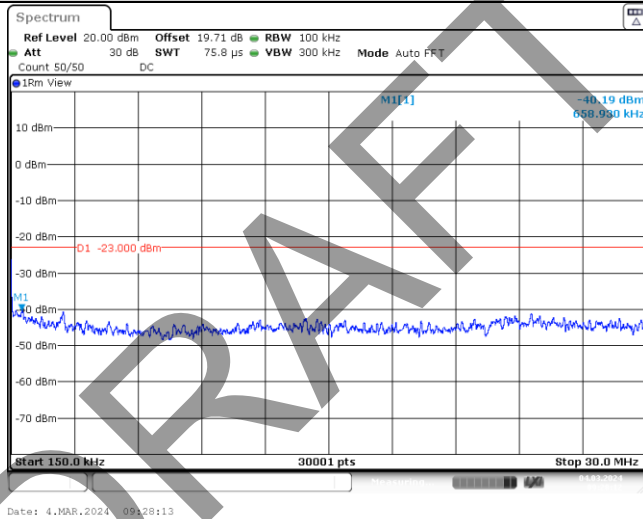

Band2-3MHz-16QAM-19185-1-0-High-0.15-30--40.19-PASS

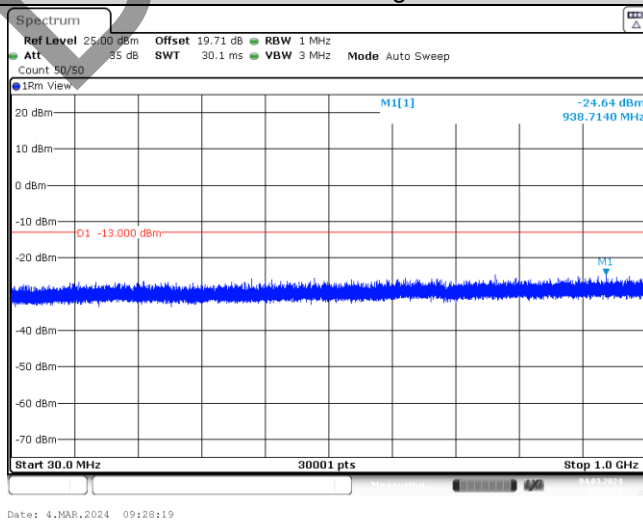

Band2-3MHz-16QAM-19185-1-0-High-30-1000--24.64-PASS

BV 7Layers Communications Technology (Shenzhen) Co., Ltd

Room B37, Warehouse A5, No.3 Chiwan 4th Road, Zhaoshang Street, Nanshan District Shenzhen, Guangdong, People's Republic of China

Tel: +86 755 8869 6566
 Fax: +86 755 8869 6577
 Email: customerservice.sw@bureauveritas.com



BUREAU VERITAS

Test Report No.: W7L-P23120015R102

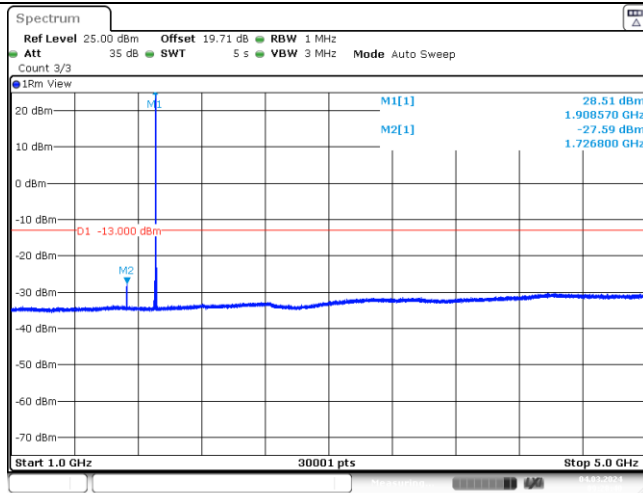

Band2-3MHz-16QAM-19185-1-0-High-1000-5000--27.59-PASS

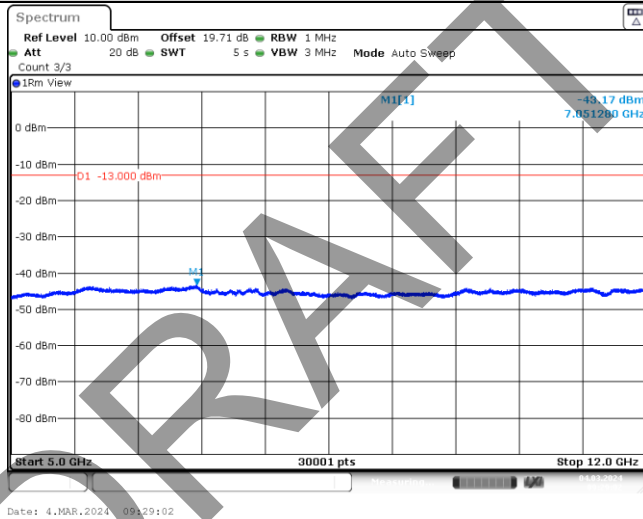

Band2-3MHz-16QAM-19185-1-0-High-5000-12000--43.17-PASS

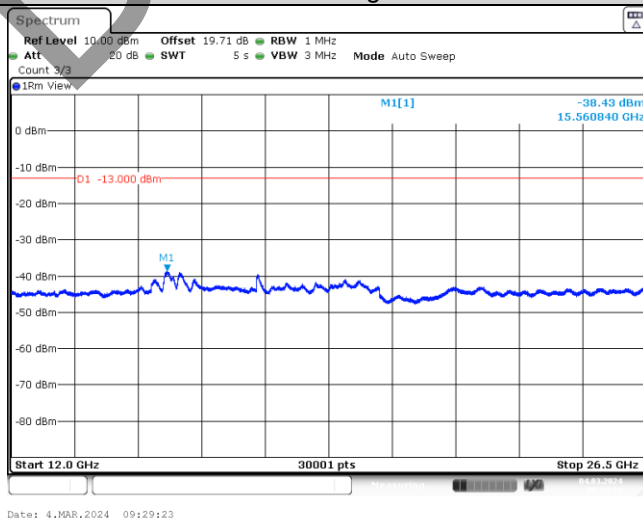

Band2-3MHz-16QAM-19185-1-0-High-12000-26500--38.43-PASS

BV 7Layers Communications Technology (Shenzhen) Co., Ltd

Room B37, Warehouse A5, No.3 Chiwan 4th Road, Zhaoshang Street, Nanshan District Shenzhen, Guangdong, People's Republic of China

Tel: +86 755 8869 6566
 Fax: +86 755 8869 6577
 Email: customerservice.sw@bureauveritas.com



BUREAU VERITAS

Test Report No.: W7L-P23120015R102

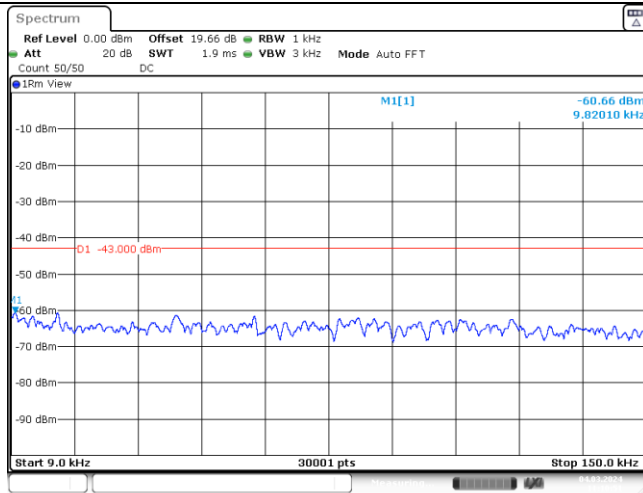

Band2-5MHz-QPSK-18625-1-0-Low-0.009-0.15--60.66-PASS

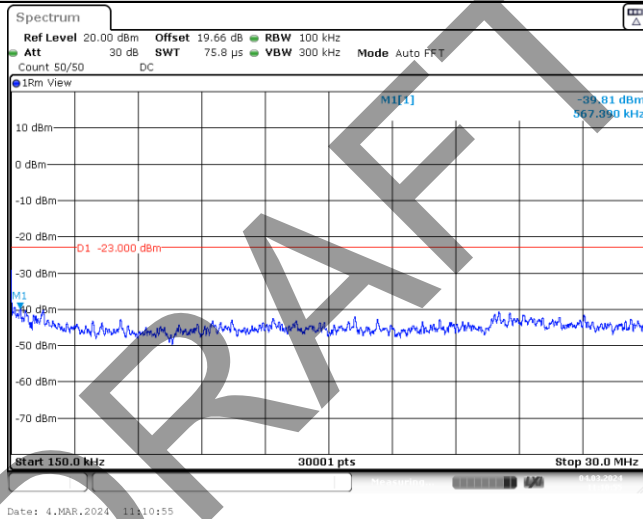

Band2-5MHz-QPSK-18625-1-0-Low-0.15-30--39.81-PASS

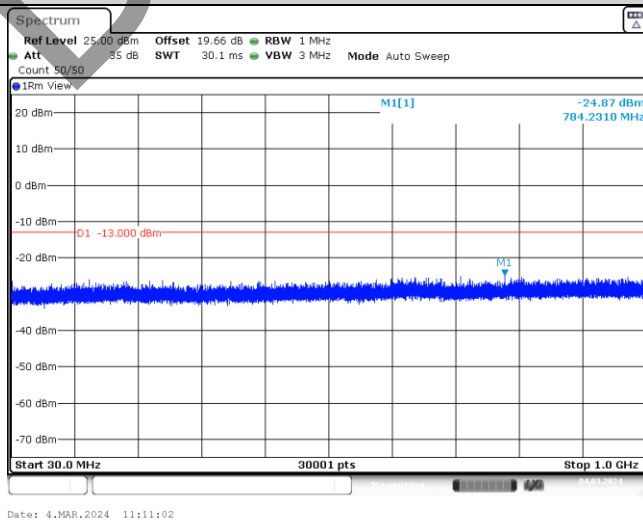

Band2-5MHz-QPSK-18625-1-0-Low-30-1000--24.87-PASS

BV 7Layers Communications Technology (Shenzhen) Co., Ltd

Room B37, Warehouse A5, No.3 Chiwan 4th Road, Zhaoshang Street, Nanshan District Shenzhen, Guangdong, People's Republic of China

Tel: +86 755 8869 6566
 Fax: +86 755 8869 6577
 Email: customerservice.sw@bureauveritas.com



BUREAU VERITAS

Test Report No.: W7L-P23120015R102

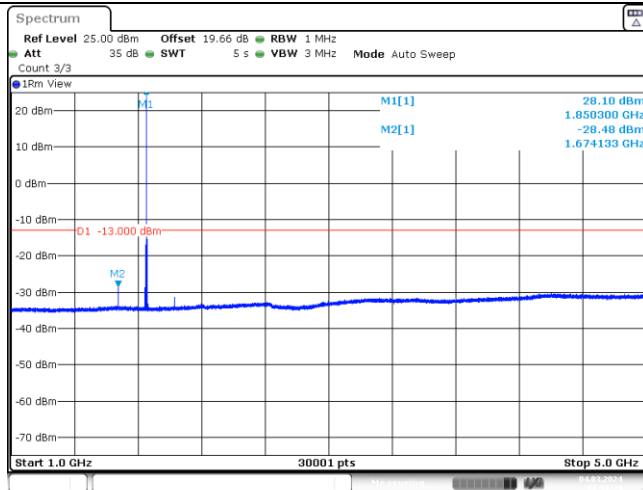

Date: 4.MAR.2024 11:11:24

Band2-5MHz-QPSK-18625-1-0-Low-1000-5000--28.48-PASS

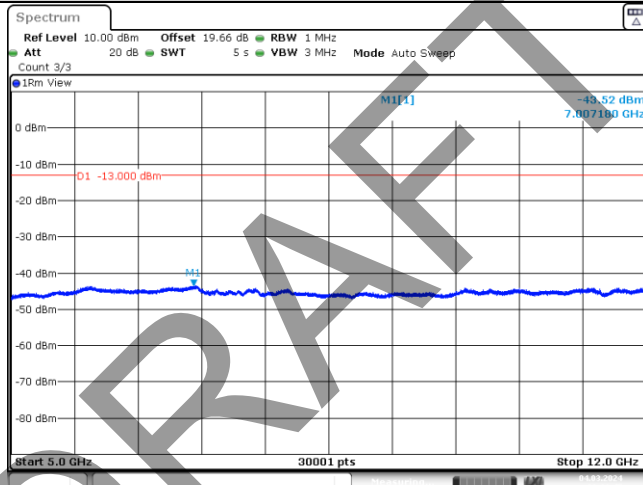

Date: 4.MAR.2024 11:11:45

Band2-5MHz-QPSK-18625-1-0-Low-5000-12000--43.52-PASS

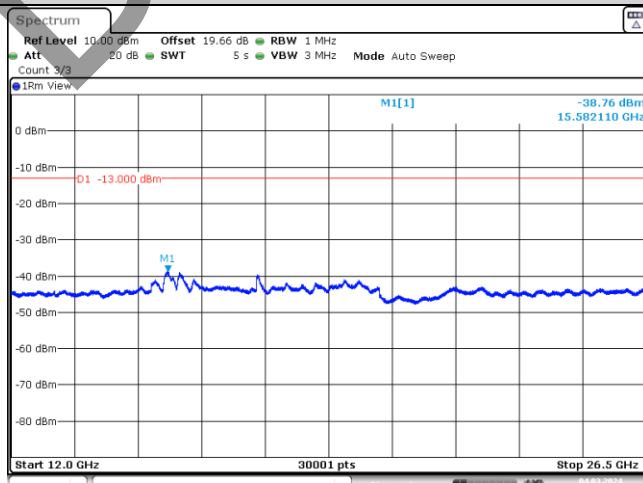

Date: 4.MAR.2024 11:12:06

Band2-5MHz-QPSK-18625-1-0-Low-12000-26500--38.76-PASS

BV 7Layers Communications Technology (Shenzhen) Co., Ltd

Room B37, Warehouse A5, No.3 Chiwan 4th Road, Zhaoshang Street, Nanshan District Shenzhen, Guangdong, People's Republic of China

Tel: +86 755 8869 6566 Fax: +86 755 8869 6577

Email: customerservice.sw@bureauveritas.com



BUREAU VERITAS

Test Report No.: W7L-P23120015R102

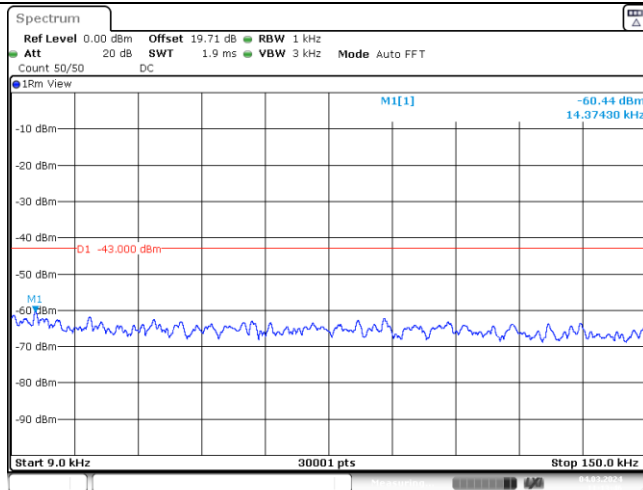

Date: 4.MAR.2024 11:13:46

Band2-5MHz-QPSK-18900-1-0-Low-0.009-0.15--60.44-PASS

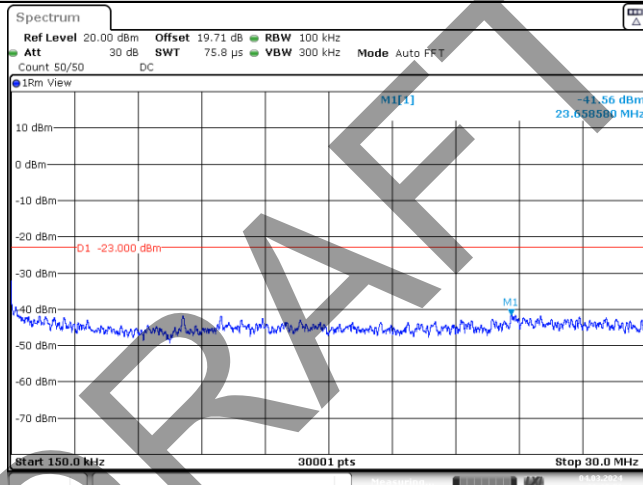

Date: 4.MAR.2024 11:13:51

Band2-5MHz-QPSK-18900-1-0-Low-0.15-30--41.56-PASS

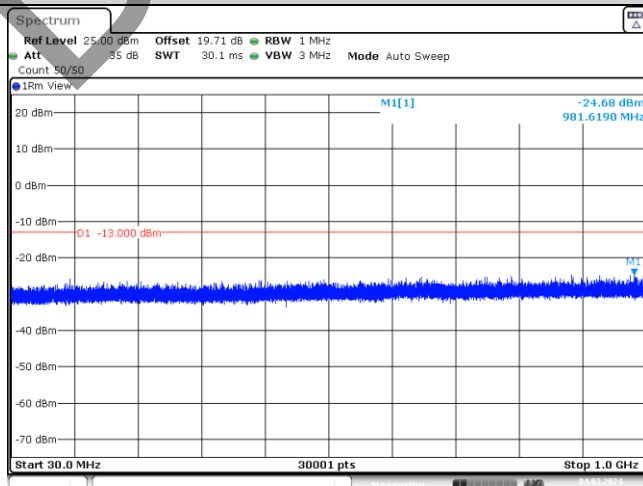

Date: 4.MAR.2024 11:13:57

Band2-5MHz-QPSK-18900-1-0-Low-30-1000--24.68-PASS

BV 7Layers Communications Technology (Shenzhen) Co., Ltd

Room B37, Warehouse A5, No.3 Chiwan 4th Road, Zhaoshang Street, Nanshan District Shenzhen, Guangdong, People's Republic of China

Tel: +86 755 8869 6566 Fax: +86 755 8869 6577

Email: customerservice.sw@bureauveritas.com



BUREAU VERITAS

Test Report No.: W7L-P23120015R102

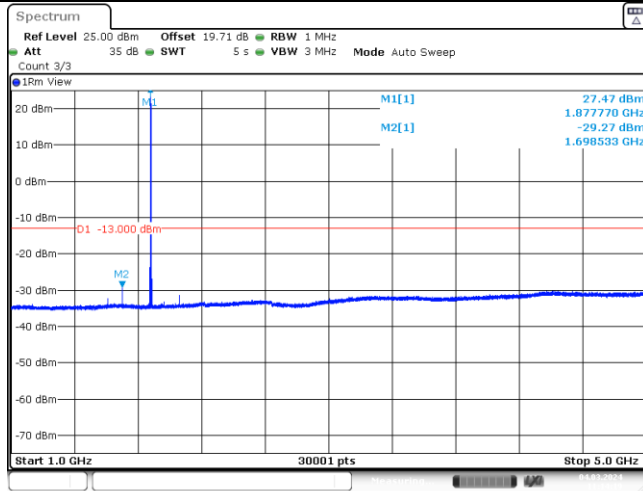

Band2-5MHz-QPSK-18900-1-0-Low-1000-5000--29.27-PASS

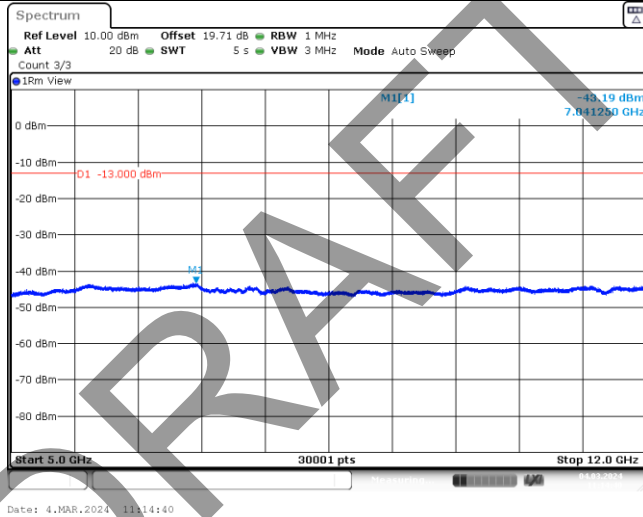

Band2-5MHz-QPSK-18900-1-0-Low-5000-12000--43.19-PASS

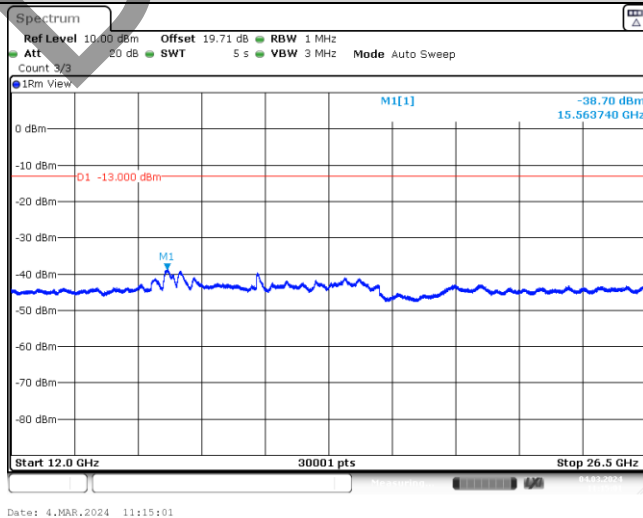

Band2-5MHz-QPSK-18900-1-0-Low-12000-26500--38.7-PASS

BV 7Layers Communications Technology (Shenzhen) Co., Ltd

Room B37, Warehouse A5, No.3 Chiwan 4th Road, Zhaoshang Street, Nanshan District Shenzhen, Guangdong, People's Republic of China

Tel: +86 755 8869 6566
 Fax: +86 755 8869 6577
 Email: customerservice.sw@bureauveritas.com



BUREAU VERITAS

Test Report No.: W7L-P23120015R102

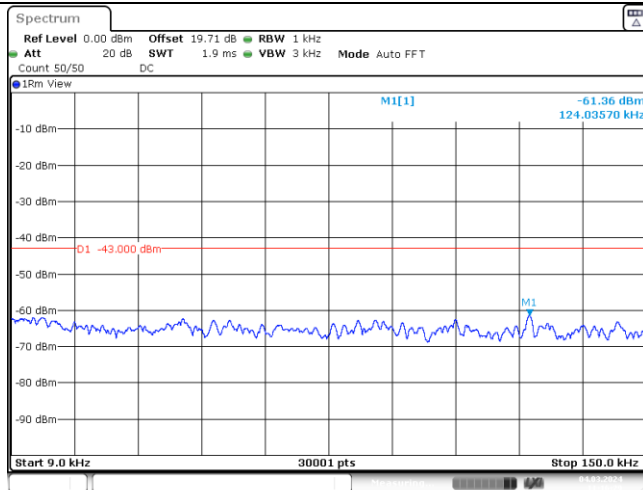

Date: 4.MAR.2024 11:16:29

Band2-5MHz-QPSK-19175-1-0-High-0.009-0.15--61.36-PASS

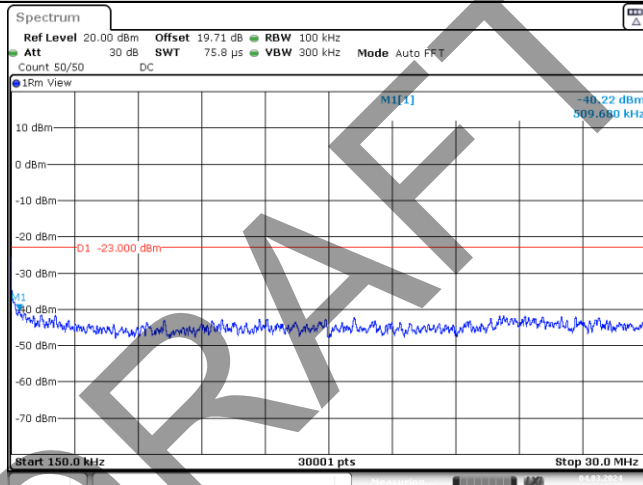

Date: 4.MAR.2024 11:16:33

Band2-5MHz-QPSK-19175-1-0-High-0.15-30--40.22-PASS

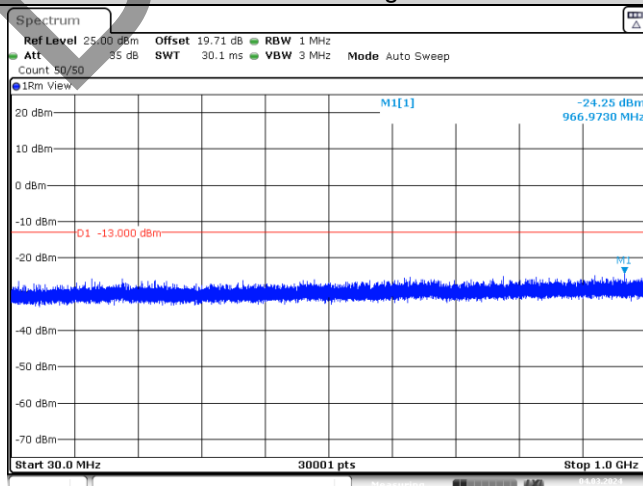

Date: 4.MAR.2024 11:16:40

Band2-5MHz-QPSK-19175-1-0-High-30-1000--24.25-PASS

BV 7Layers Communications Technology (Shenzhen) Co., Ltd

Room B37, Warehouse A5, No.3 Chiwan 4th Road, Zhaoshang Street, Nanshan District Shenzhen, Guangdong, People's Republic of China

Tel: +86 755 8869 6566 Fax: +86 755 8869 6577

Email: customerservice.sw@bureauveritas.com



BUREAU VERITAS

Test Report No.: W7L-P23120015R102

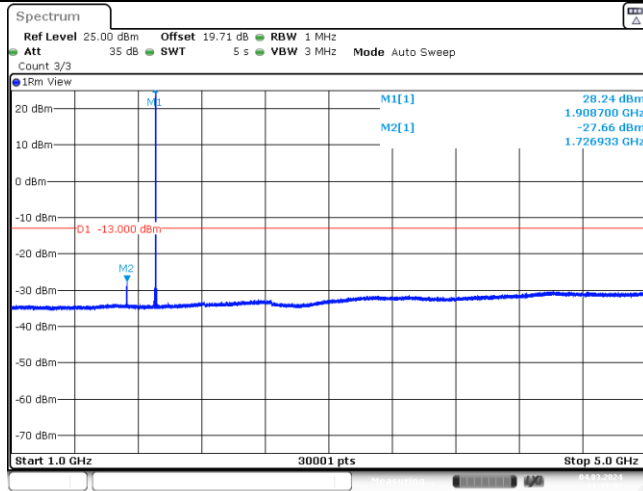

Date: 4.MAR.2024 11:17:02

Band2-5MHz-QPSK-19175-1-0-High-1000-5000--27.66-PASS

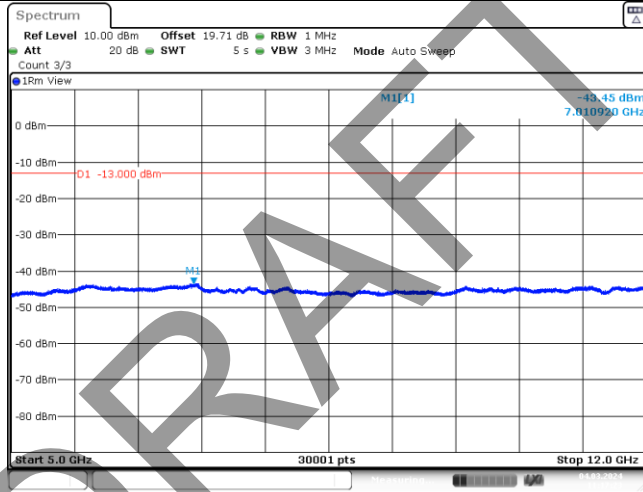

Date: 4.MAR.2024 11:17:23

Band2-5MHz-QPSK-19175-1-0-High-5000-12000--43.45-PASS

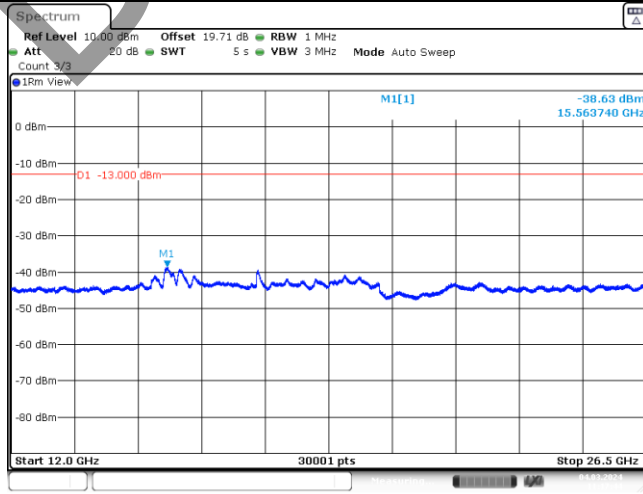

Date: 4.MAR.2024 11:17:44

Band2-5MHz-QPSK-19175-1-0-High-12000-26500--38.63-PASS

BV 7Layers Communications Technology (Shenzhen) Co., Ltd

Room B37, Warehouse A5, No.3 Chiwan 4th Road, Zhaoshang Street, Nanshan District Shenzhen, Guangdong, People's Republic of China

Tel: +86 755 8869 6566 Fax: +86 755 8869 6577

Email: customerservice.sw@bureauveritas.com



BUREAU VERITAS

Test Report No.: W7L-P23120015R102

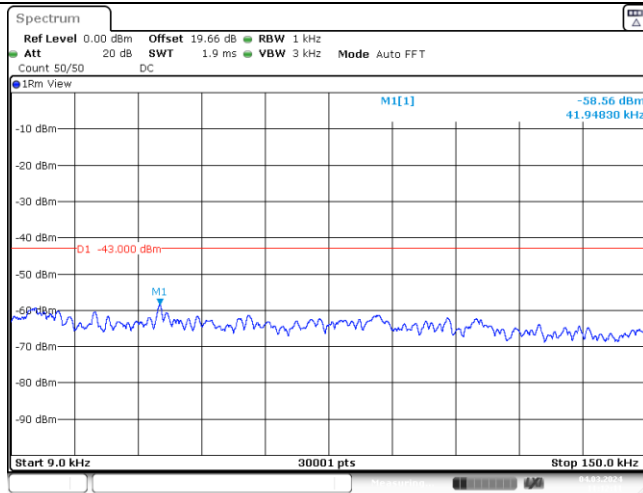

Band2-5MHz-16QAM-18625-1-0-Low-0.009-0.15--58.56-PASS

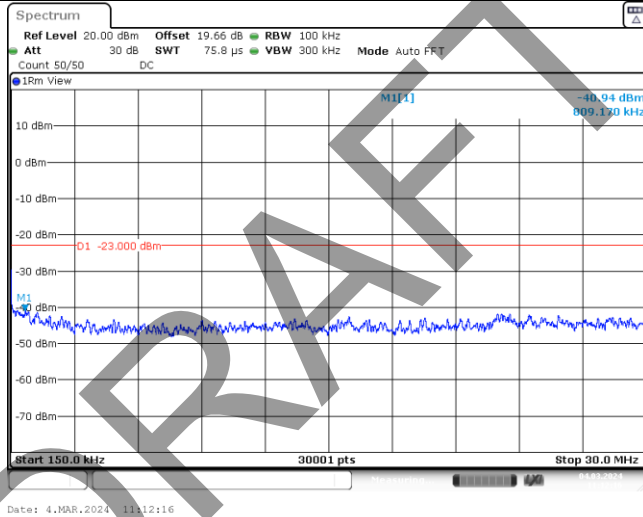

Band2-5MHz-16QAM-18625-1-0-Low-0.15-30--40.94-PASS

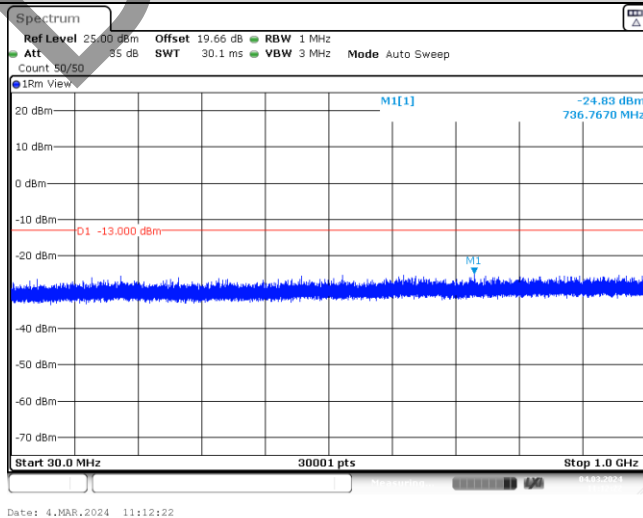

Band2-5MHz-16QAM-18625-1-0-Low-30-1000--24.83-PASS

BV 7Layers Communications Technology (Shenzhen) Co., Ltd

Room B37, Warehouse A5, No.3 Chiwan 4th Road, Zhaoshang Street, Nanshan District Shenzhen, Guangdong, People's Republic of China

Tel: +86 755 8869 6566 Fax: +86 755 8869 6577

Email: customerservice.sw@bureauveritas.com



BUREAU VERITAS

Test Report No.: W7L-P23120015R102

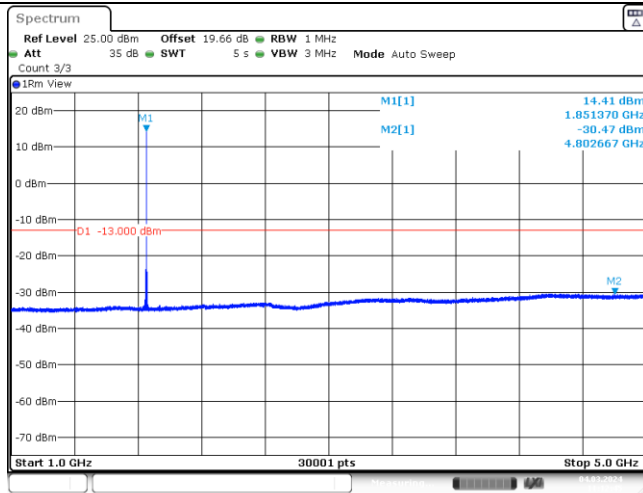

Band2-5MHz-16QAM-18625-1-0-Low-1000-5000--30.47-PASS

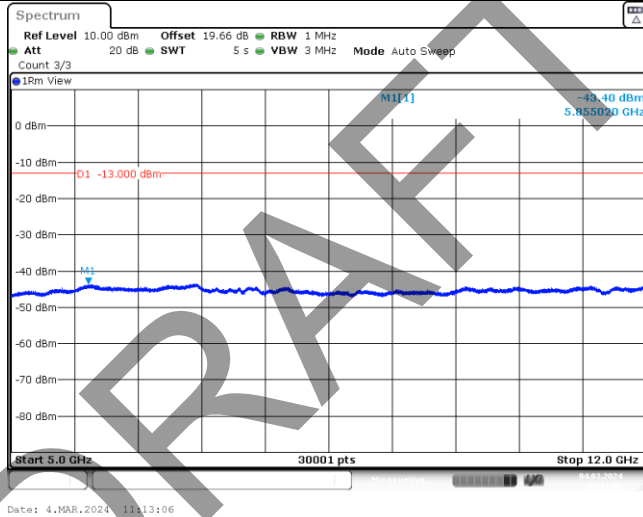

Band2-5MHz-16QAM-18625-1-0-Low-5000-12000--43.4-PASS

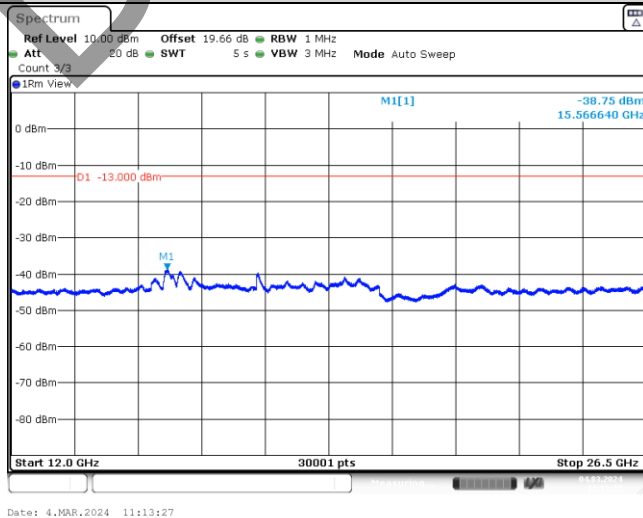

Band2-5MHz-16QAM-18625-1-0-Low-12000-26500--38.75-PASS

BV 7Layers Communications Technology (Shenzhen) Co., Ltd

Room B37, Warehouse A5, No.3 Chiwan 4th Road, Zhaoshang Street, Nanshan District Shenzhen, Guangdong, People's Republic of China

Tel: +86 755 8869 6566 Fax: +86 755 8869 6577 Email: customerservice.sw@bureauveritas.com



BUREAU VERITAS

Test Report No.: W7L-P23120015R102

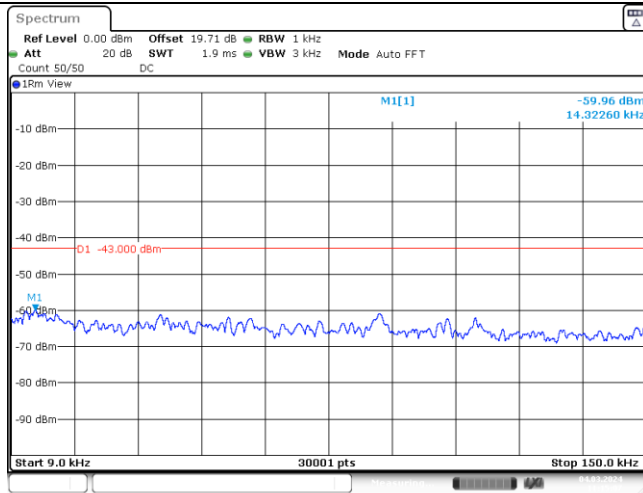

Date: 4.MAR.2024 11:15:06

Band2-5MHz-16QAM-18900-1-0-Low-0.009-0.15--59.96-PASS

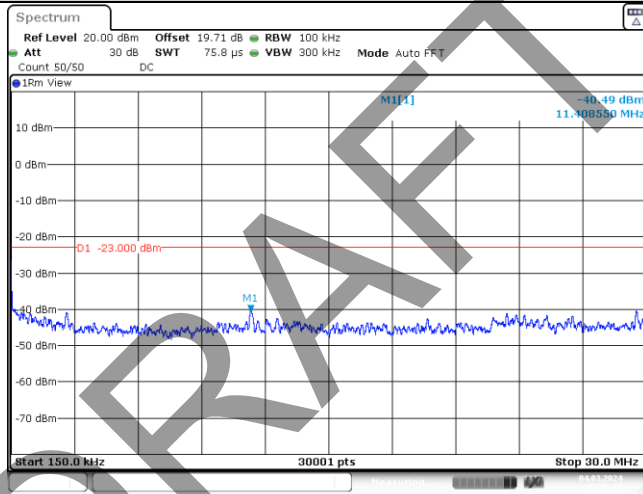

Date: 4.MAR.2024 11:15:11

Band2-5MHz-16QAM-18900-1-0-Low-0.15-30--40.49-PASS

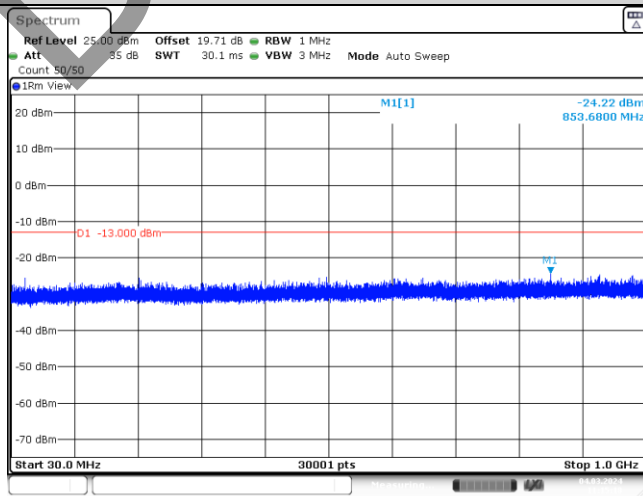

Date: 4.MAR.2024 11:15:18

Band2-5MHz-16QAM-18900-1-0-Low-30-1000--24.22-PASS

BV 7Layers Communications Technology (Shenzhen) Co., Ltd

Room B37, Warehouse A5, No.3 Chiwan 4th Road, Zhaoshang Street, Nanshan District Shenzhen, Guangdong, People's Republic of China

Tel: +86 755 8869 6566 Fax: +86 755 8869 6577

Email: customerservice.sw@bureauveritas.com



BUREAU VERITAS

Test Report No.: W7L-P23120015R102

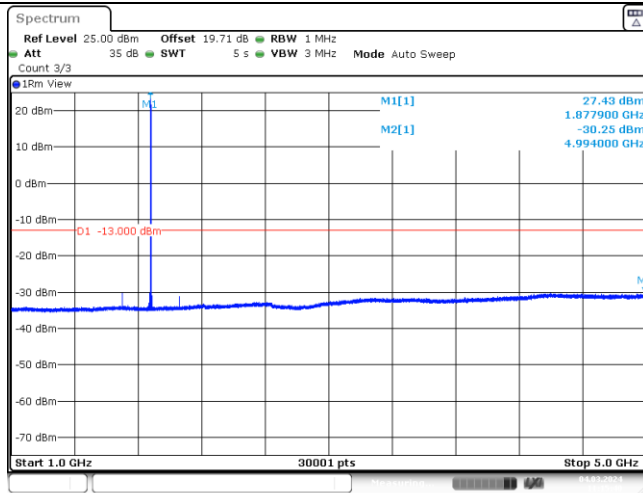

Date: 4.MAR.2024 11:15:40

Band2-5MHz-16QAM-18900-1-0-Low-1000-5000--30.25-PASS

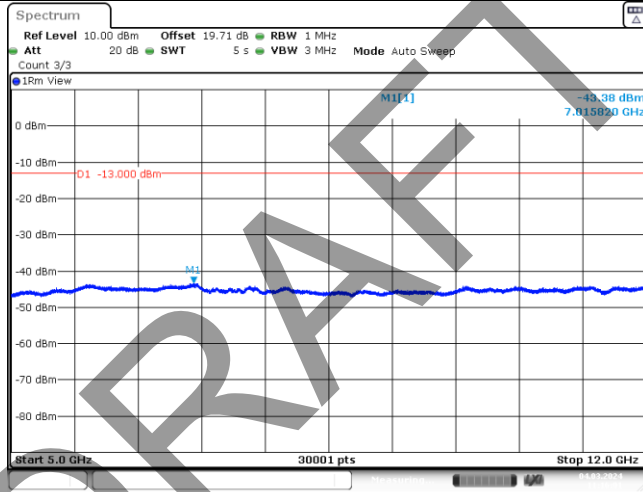

Date: 4.MAR.2024 11:16:01

Band2-5MHz-16QAM-18900-1-0-Low-5000-12000--43.38-PASS

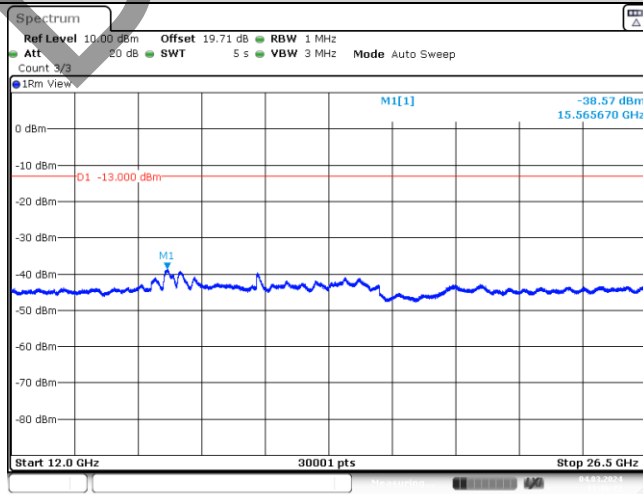

Date: 4.MAR.2024 11:16:22

Band2-5MHz-16QAM-18900-1-0-Low-12000-26500--38.57-PASS

BV 7Layers Communications Technology (Shenzhen) Co., Ltd

Room B37, Warehouse A5, No.3 Chiwan 4th Road, Zhaoshang Street, Nanshan District Shenzhen, Guangdong, People's Republic of China

Tel: +86 755 8869 6566 Fax: +86 755 8869 6577

Email: customerservice.sw@bureauveritas.com



BUREAU VERITAS

Test Report No.: W7L-P23120015R102

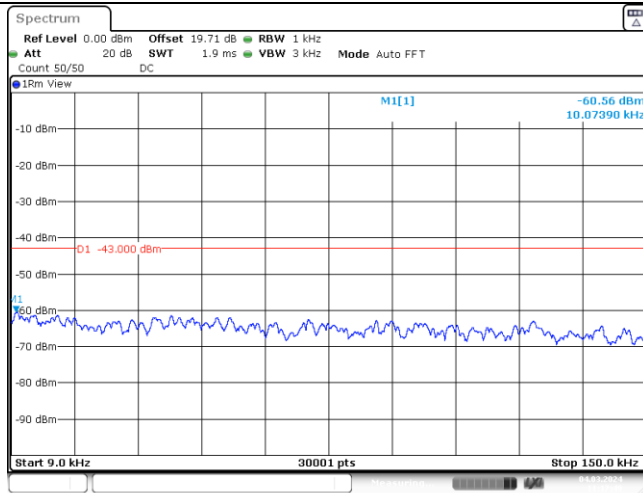

Band2-5MHz-16QAM-19175-1-0-High-0.009-0.15--60.56-PASS

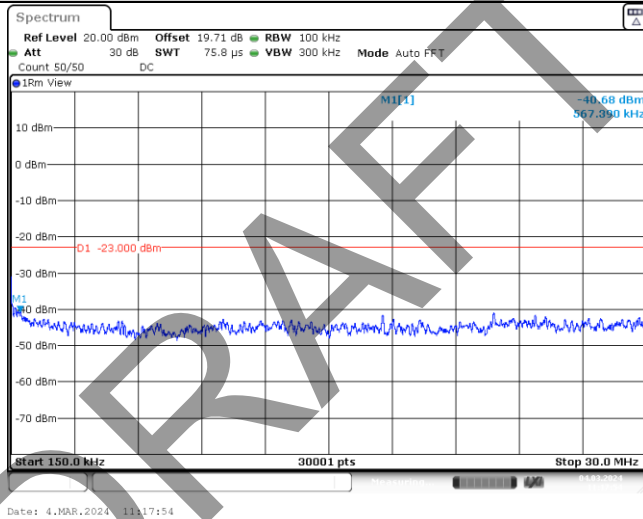

Band2-5MHz-16QAM-19175-1-0-High-0.15-30--40.68-PASS

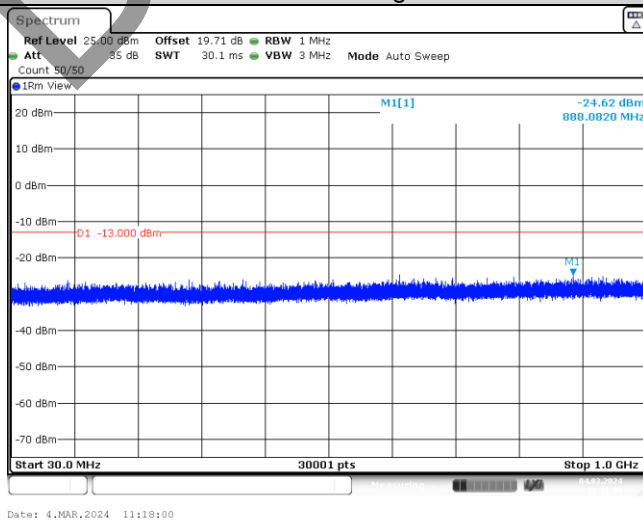

Band2-5MHz-16QAM-19175-1-0-High-30-1000--24.62-PASS

BV 7Layers Communications Technology (Shenzhen) Co., Ltd

Room B37, Warehouse A5, No.3 Chiwan 4th Road, Zhaoshang Street, Nanshan District Shenzhen, Guangdong, People's Republic of China

Tel: +86 755 8869 6566
 Fax: +86 755 8869 6577
 Email: customerservice.sw@bureauveritas.com



BUREAU VERITAS

Test Report No.: W7L-P23120015R102

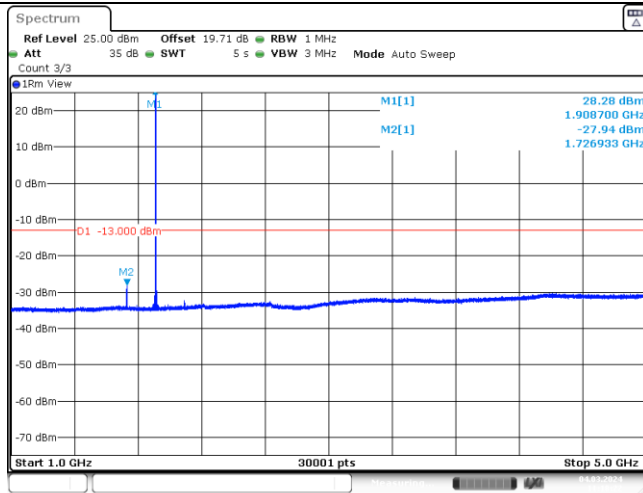

Band2-5MHz-16QAM-19175-1-0-High-1000-5000--27.94-PASS

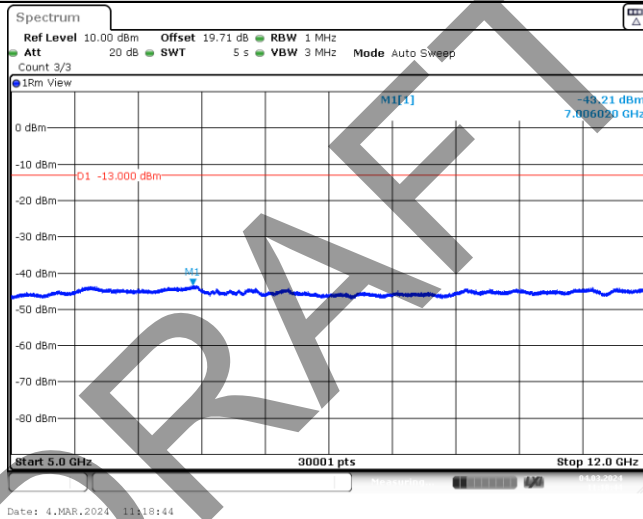

Band2-5MHz-16QAM-19175-1-0-High-5000-12000--43.21-PASS

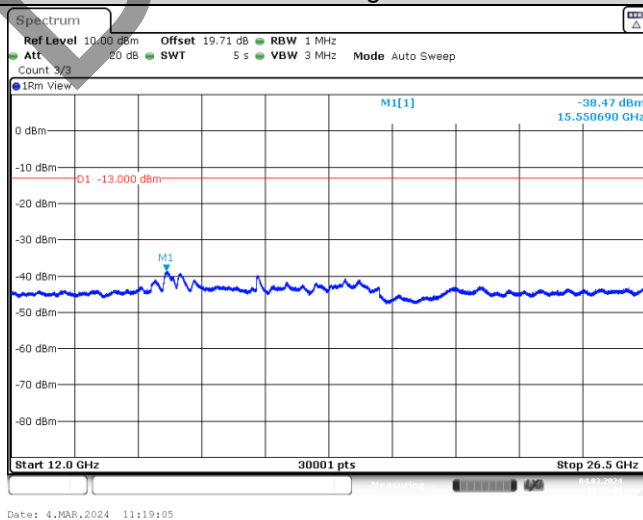

Band2-5MHz-16QAM-19175-1-0-High-12000-26500--38.47-PASS

BV 7Layers Communications Technology (Shenzhen) Co., Ltd

Room B37, Warehouse A5, No.3 Chiwan 4th Road, Zhaoshang Street, Nanshan District Shenzhen, Guangdong, People's Republic of China

Tel: +86 755 8869 6566 Fax: +86 755 8869 6577

Email: customerservice.sw@bureauveritas.com



BUREAU VERITAS

Test Report No.: W7L-P23120015R102

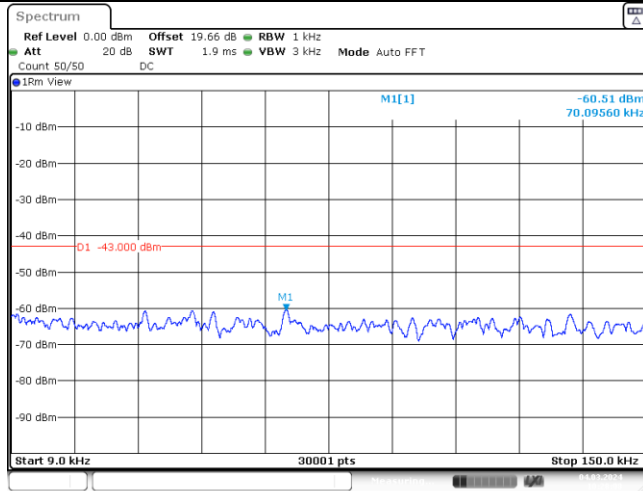

Band2-10MHz-QPSK-18650-1-0-Low-0.009-0.15--60.51-PASS

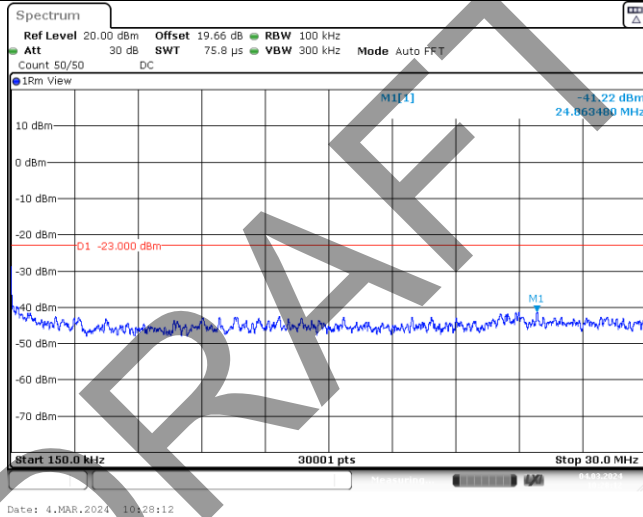

Band2-10MHz-QPSK-18650-1-0-Low-0.15-30--41.22-PASS

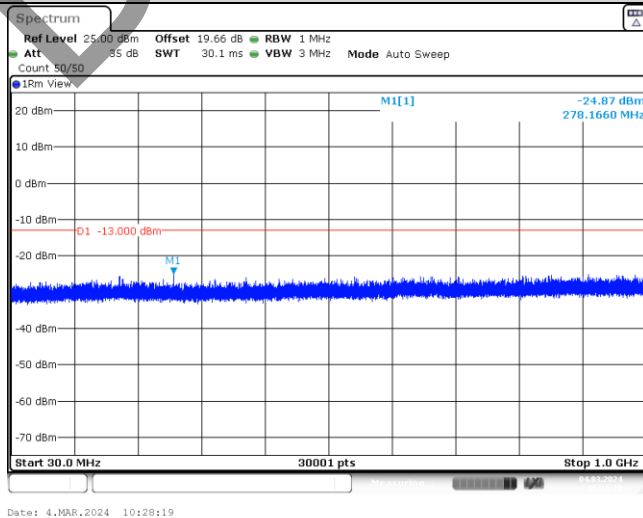

Band2-10MHz-QPSK-18650-1-0-Low-30-1000--24.87-PASS

BV 7Layers Communications Technology (Shenzhen) Co., Ltd

Room B37, Warehouse A5, No.3 Chiwan 4th Road, Zhaoshang Street, Nanshan District Shenzhen, Guangdong, People's Republic of China

Tel: +86 755 8869 6566
 Fax: +86 755 8869 6577
 Email: customerservice.sw@bureauveritas.com



BUREAU VERITAS

Test Report No.: W7L-P23120015R102

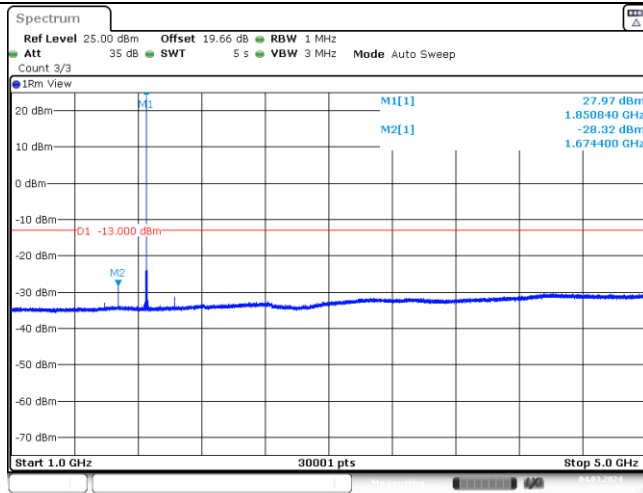

Band2-10MHz-QPSK-18650-1-0-Low-1000-5000--28.32-PASS

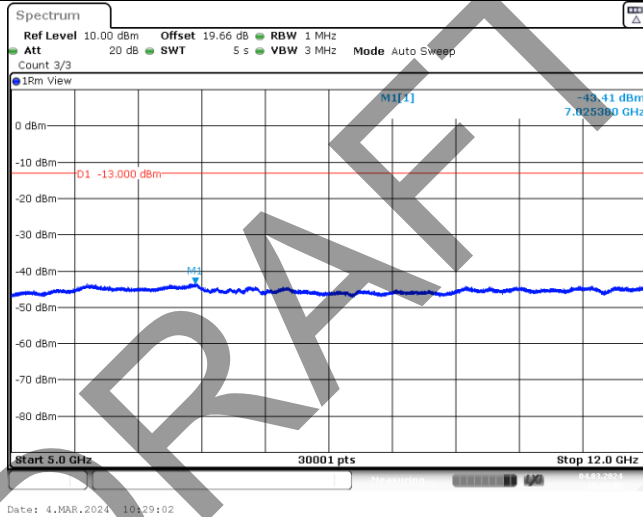

Band2-10MHz-QPSK-18650-1-0-Low-5000-12000--43.41-PASS

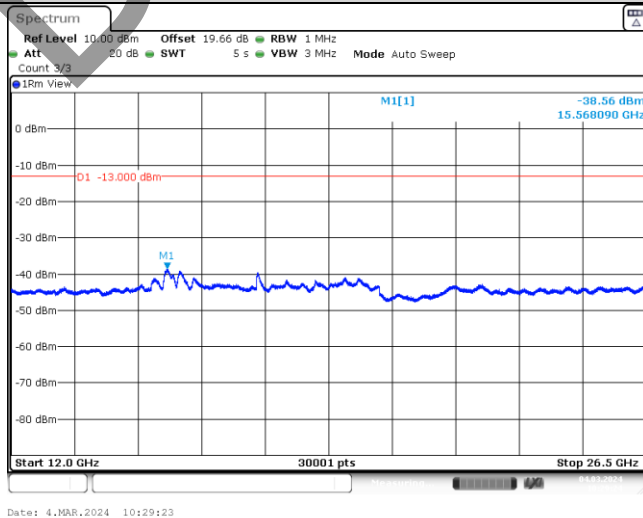

Band2-10MHz-QPSK-18650-1-0-Low-12000-26500--38.56-PASS

BV 7Layers Communications Technology (Shenzhen) Co., Ltd

Room B37, Warehouse A5, No.3 Chiwan 4th Road, Zhaoshang Street, Nanshan District Shenzhen, Guangdong, People's Republic of China

Tel: +86 755 8869 6566
 Fax: +86 755 8869 6577
 Email: customerservice.sw@bureauveritas.com



BUREAU VERITAS

Test Report No.: W7L-P23120015R102

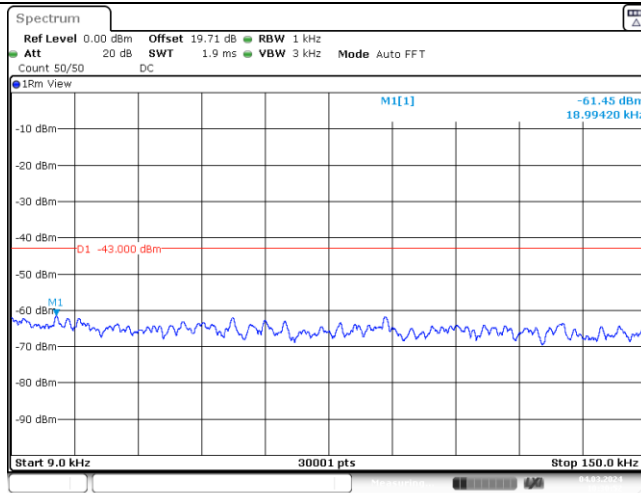

Date: 4.MAR.2024 10:30:52

Band2-10MHz-QPSK-18900-1-0-Low-0.009-0.15--61.45-PASS

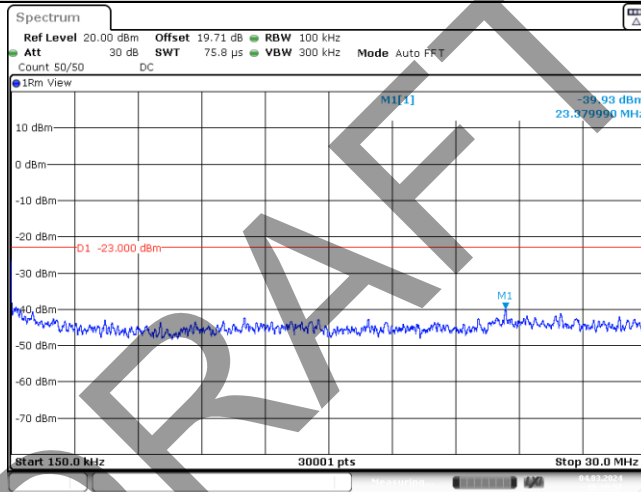

Date: 4.MAR.2024 10:30:57

Band2-10MHz-QPSK-18900-1-0-Low-0.15-30--39.93-PASS

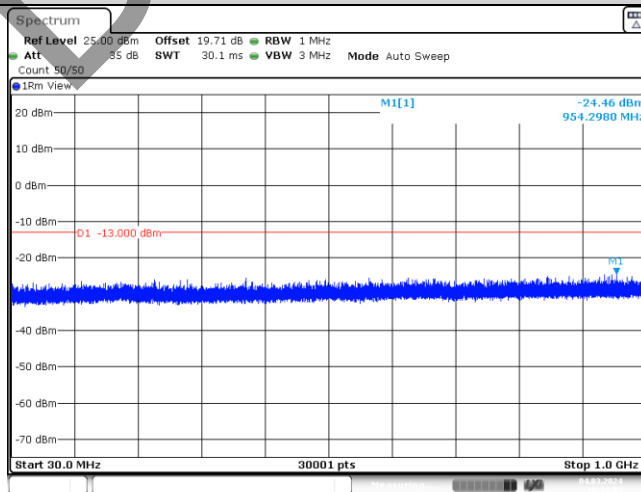

Date: 4.MAR.2024 10:31:03

Band2-10MHz-QPSK-18900-1-0-Low-30-1000--24.46-PASS

BV 7Layers Communications Technology (Shenzhen) Co., Ltd

Room B37, Warehouse A5, No.3 Chiwan 4th Road, Zhaoshang Street, Nanshan District Shenzhen, Guangdong, People's Republic of China

Tel: +86 755 8869 6566 Fax: +86 755 8869 6577

Email: customerservice.sw@bureauveritas.com



BUREAU VERITAS

Test Report No.: W7L-P23120015R102

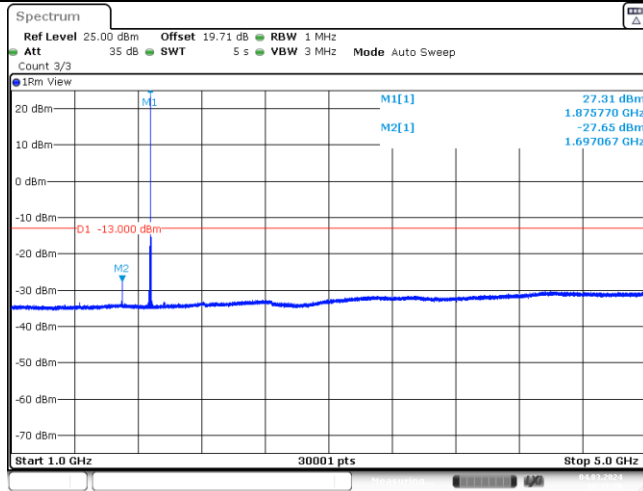

Band2-10MHz-QPSK-18900-1-0-Low-1000-5000--27.65-PASS

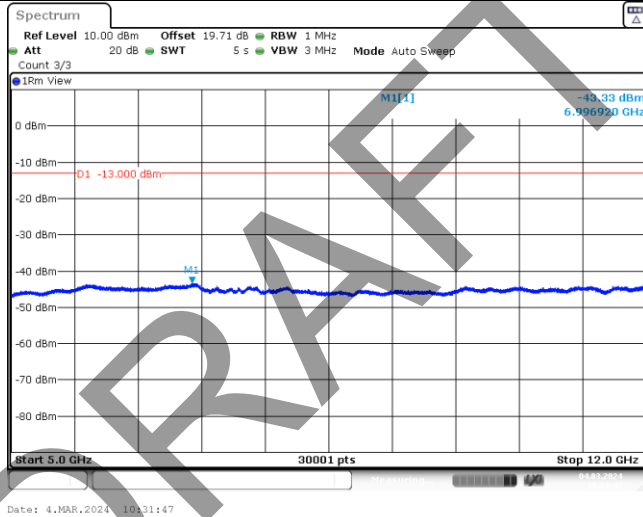

Band2-10MHz-QPSK-18900-1-0-Low-5000-12000--43.33-PASS

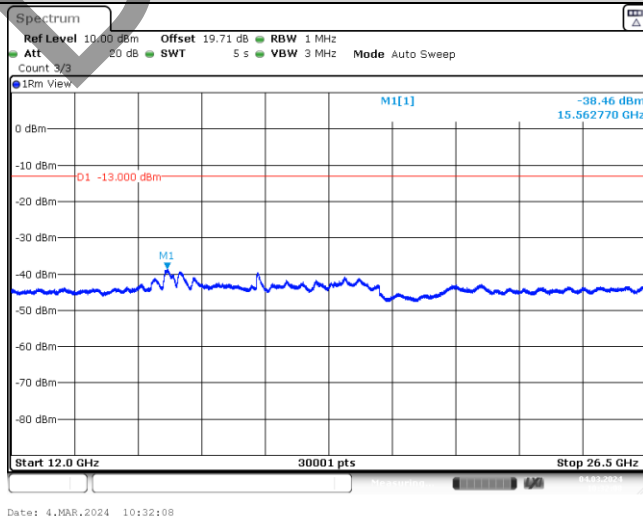

Band2-10MHz-QPSK-18900-1-0-Low-12000-26500--38.46-PASS

BV 7Layers Communications Technology (Shenzhen) Co., Ltd

Room B37, Warehouse A5, No.3 Chiwan 4th Road, Zhaoshang Street, Nanshan District Shenzhen, Guangdong, People's Republic of China

Tel: +86 755 8869 6566
 Fax: +86 755 8869 6577
 Email: customerservice.sw@bureauveritas.com



BUREAU VERITAS

Test Report No.: W7L-P23120015R102

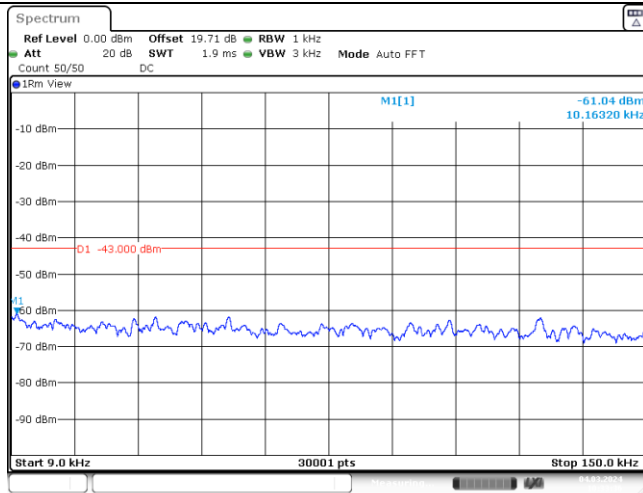

Band2-10MHz-QPSK-19150-1-0-High-0.009-0.15--61.04-PASS

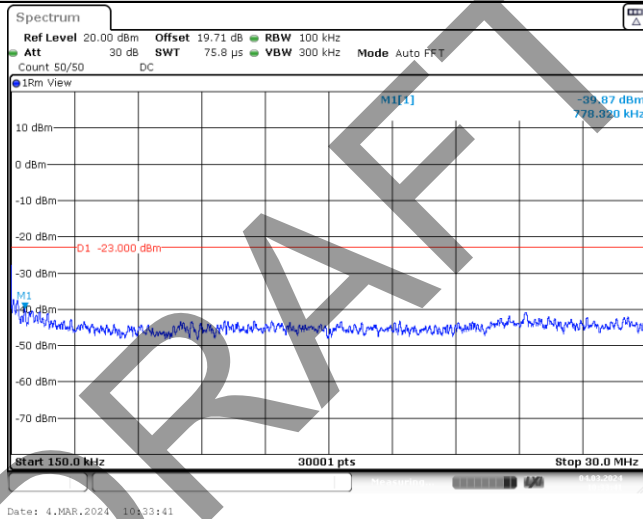

Band2-10MHz-QPSK-19150-1-0-High-0.15-30--39.87-PASS

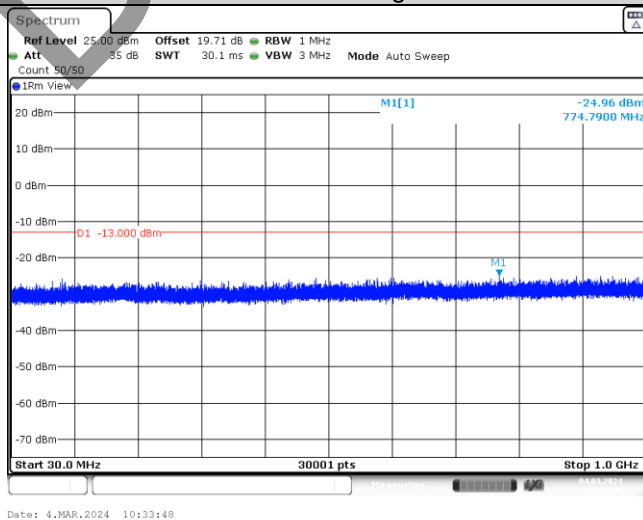

Band2-10MHz-QPSK-19150-1-0-High-30-1000--24.96-PASS

BV 7Layers Communications Technology (Shenzhen) Co., Ltd

Room B37, Warehouse A5, No.3 Chiwan 4th Road, Zhaoshang Street, Nanshan District Shenzhen, Guangdong, People's Republic of China

Tel: +86 755 8869 6566 Fax: +86 755 8869 6577

Email: customerservice.sw@bureauveritas.com



BUREAU VERITAS

Test Report No.: W7L-P23120015R102

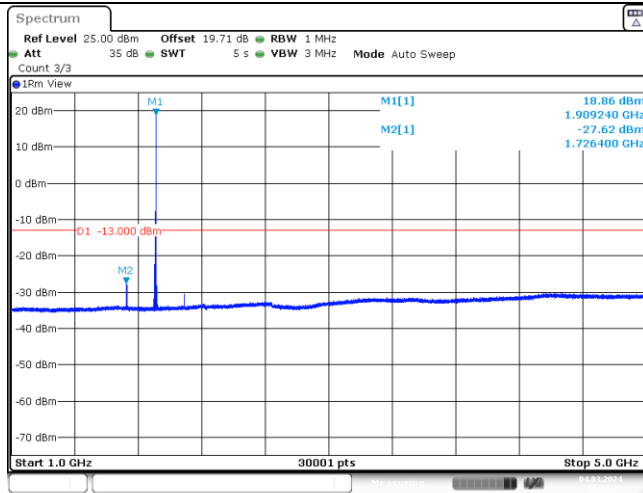

Band2-10MHz-QPSK-19150-1-0-High-1000-5000--27.62-PASS

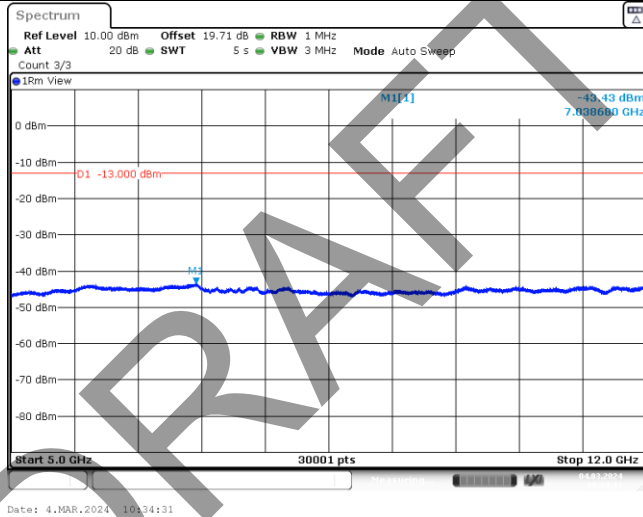

Band2-10MHz-QPSK-19150-1-0-High-5000-12000--43.43-PASS

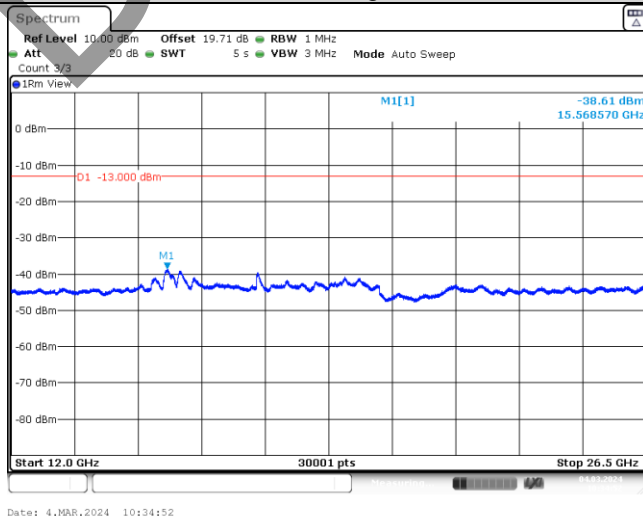

Band2-10MHz-QPSK-19150-1-0-High-12000-26500--38.61-PASS

BV 7Layers Communications Technology (Shenzhen) Co., Ltd

Room B37, Warehouse A5, No.3 Chiwan 4th Road, Zhaoshang Street, Nanshan District Shenzhen, Guangdong, People's Republic of China

Tel: +86 755 8869 6566 Fax: +86 755 8869 6577

Email: customerservice.sw@bureauveritas.com



BUREAU VERITAS

Test Report No.: W7L-P23120015R102

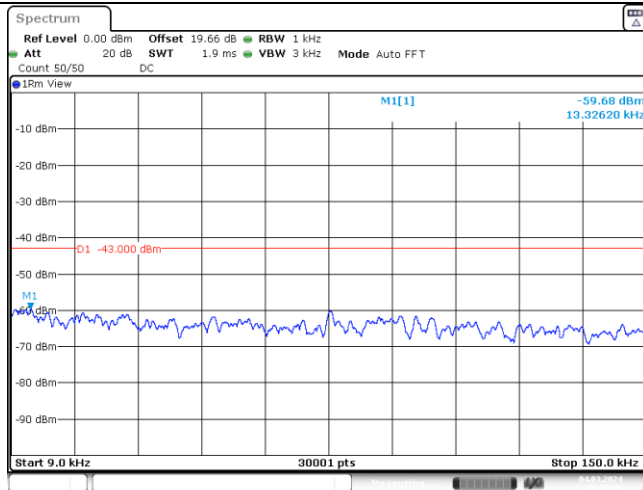

Date: 4.MAR.2024 10:29:29

Band2-10MHz-16QAM-18650-1-0-Low-0.009-0.15--59.68-PASS

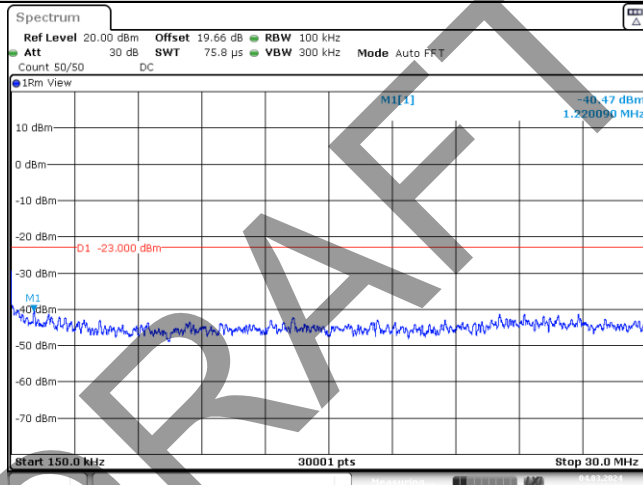

Date: 4.MAR.2024 10:29:33

Band2-10MHz-16QAM-18650-1-0-Low-0.15-30--40.47-PASS

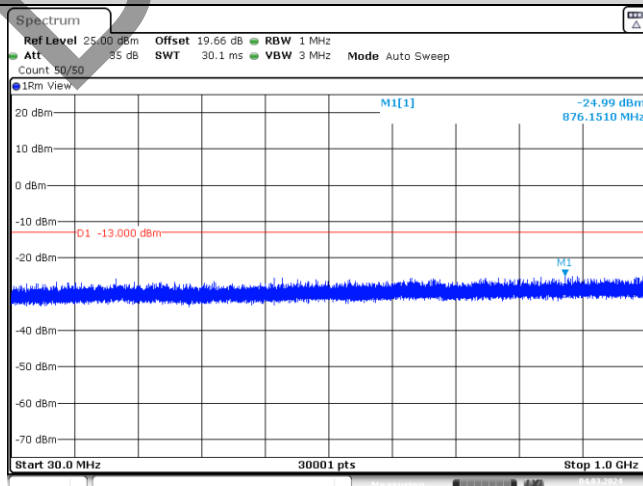

Date: 4.MAR.2024 10:29:40

Band2-10MHz-16QAM-18650-1-0-Low-30-1000--24.99-PASS



BUREAU VERITAS

Test Report No.: W7L-P23120015R102

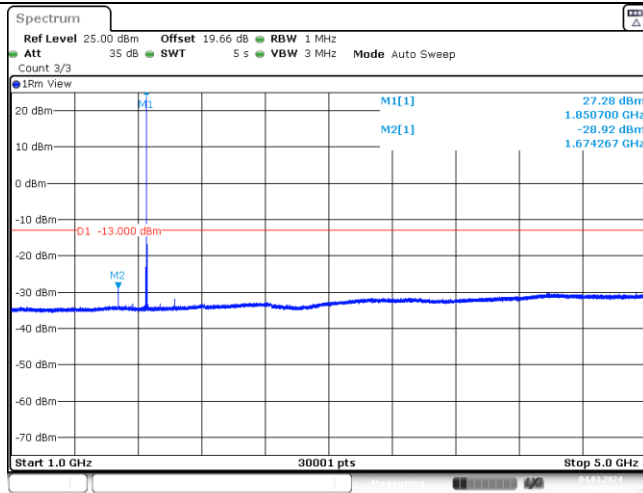

Date: 4.MAR.2024 10:30:02

Band2-10MHz-16QAM-18650-1-0-Low-1000-5000--28.92-PASS

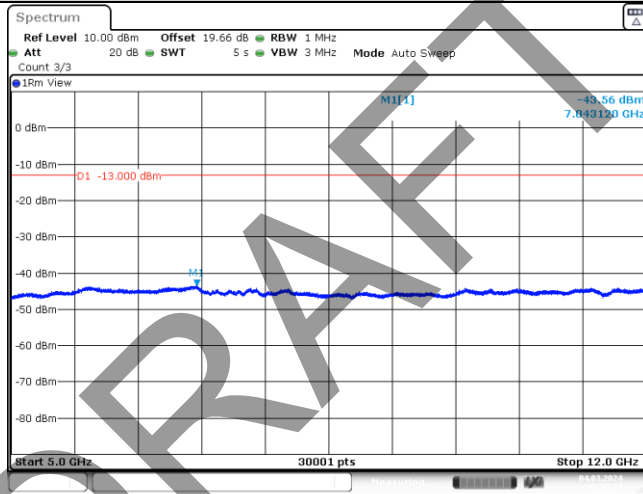

Date: 4.MAR.2024 10:30:24

Band2-10MHz-16QAM-18650-1-0-Low-5000-12000--43.56-PASS

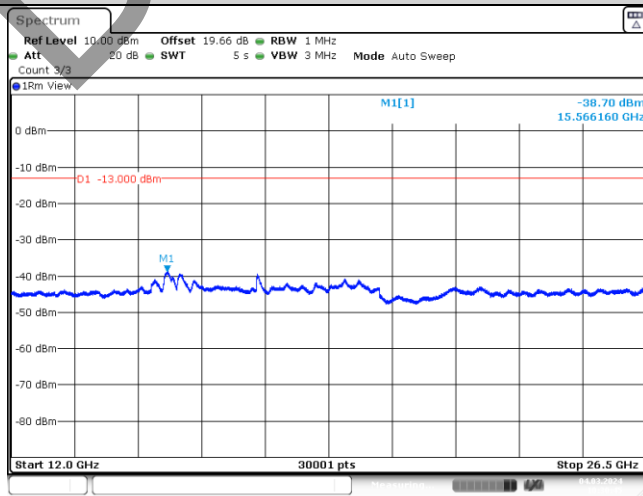

Date: 4.MAR.2024 10:30:45

Band2-10MHz-16QAM-18650-1-0-Low-12000-26500--38.7-PASS

BV 7Layers Communications Technology (Shenzhen) Co., Ltd

Room B37, Warehouse A5, No.3 Chiwan 4th Road, Zhaoshang Street, Nanshan District Shenzhen, Guangdong, People's Republic of China

Tel: +86 755 8869 6566 Fax: +86 755 8869 6577 Email: customerservice.sw@bureauveritas.com



BUREAU VERITAS

Test Report No.: W7L-P23120015R102

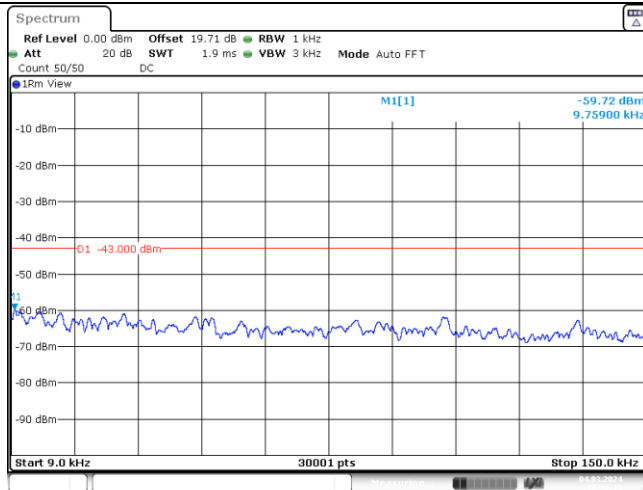

Date: 4.MAR.2024 10:32:13

Band2-10MHz-16QAM-18900-1-0-Low-0.009-0.15--59.72-PASS

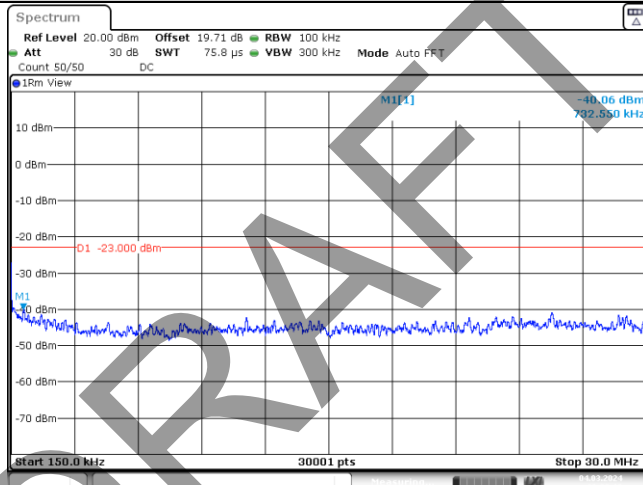

Date: 4.MAR.2024 10:32:18

Band2-10MHz-16QAM-18900-1-0-Low-0.15-30--40.06-PASS

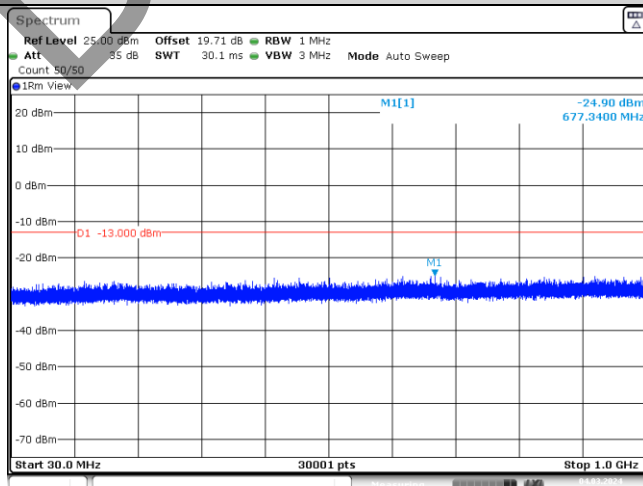

Date: 4.MAR.2024 10:32:25

Band2-10MHz-16QAM-18900-1-0-Low-30-1000--24.9-PASS

BV 7Layers Communications Technology (Shenzhen) Co., Ltd

Room B37, Warehouse A5, No.3 Chiwan 4th Road, Zhaoshang Street, Nanshan District Shenzhen, Guangdong, People's Republic of China

Tel: +86 755 8869 6566 Fax: +86 755 8869 6577

Email: customerservice.sw@bureauveritas.com



BUREAU VERITAS

Test Report No.: W7L-P23120015R102

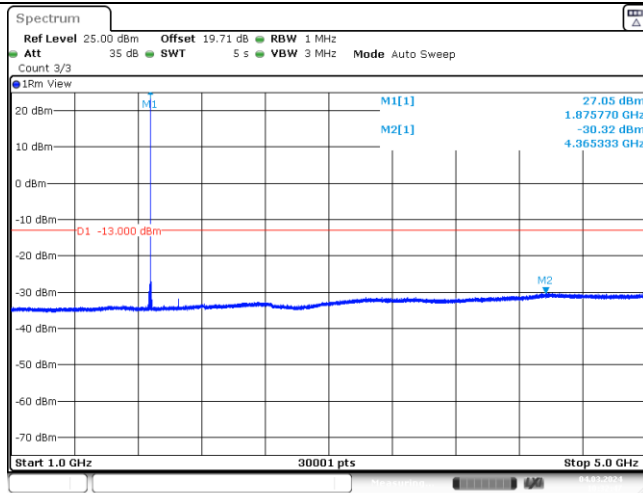

Band2-10MHz-16QAM-18900-1-0-Low-1000-5000--30.32-PASS

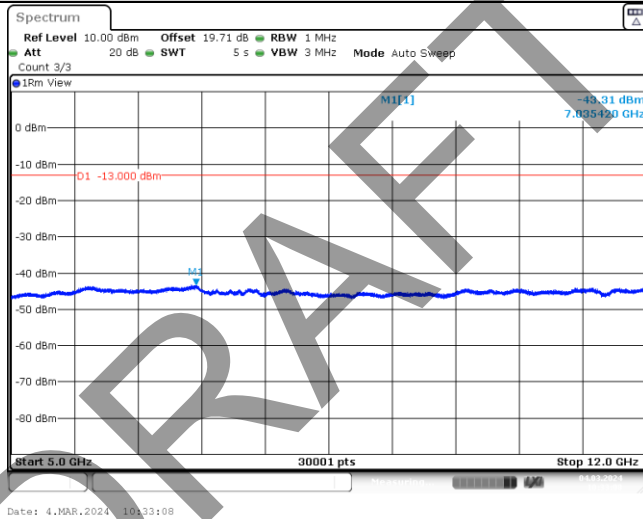

Band2-10MHz-16QAM-18900-1-0-Low-5000-12000--43.31-PASS

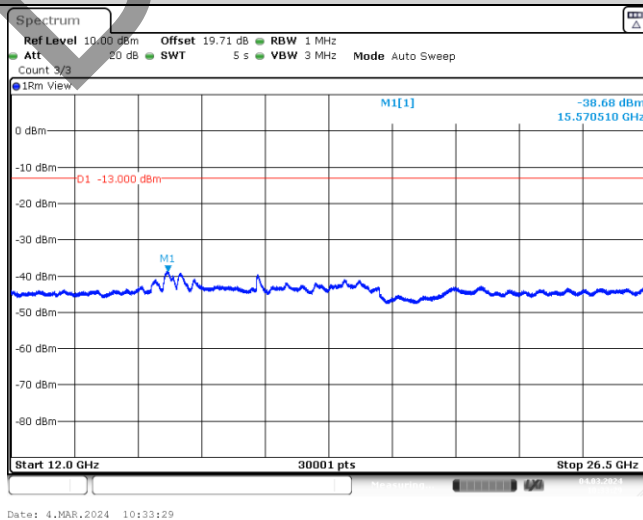

Band2-10MHz-16QAM-18900-1-0-Low-12000-26500--38.68-PASS



BUREAU VERITAS

Test Report No.: W7L-P23120015R102

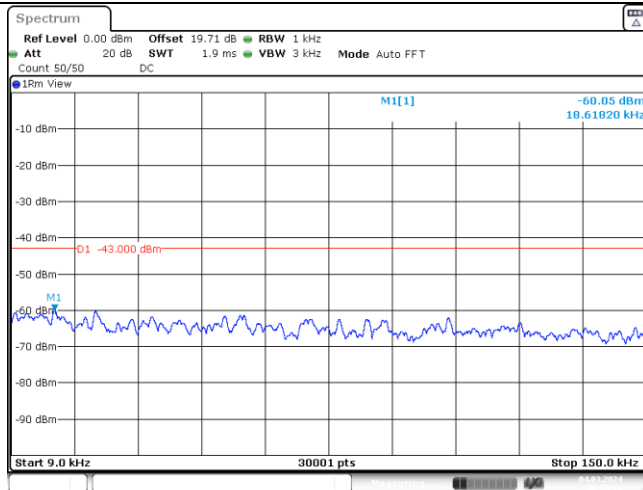

Date: 4.MAR.2024 10:34:58

Band2-10MHz-16QAM-19150-1-0-High-0.009-0.15--60.05-PASS

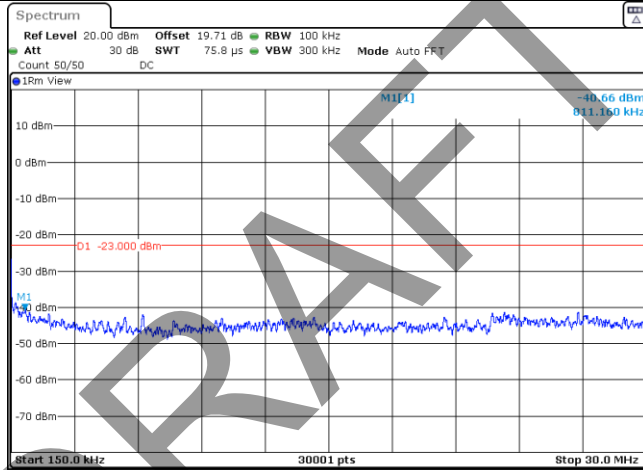

Date: 4.MAR.2024 10:35:02

Band2-10MHz-16QAM-19150-1-0-High-0.15-30--40.66-PASS

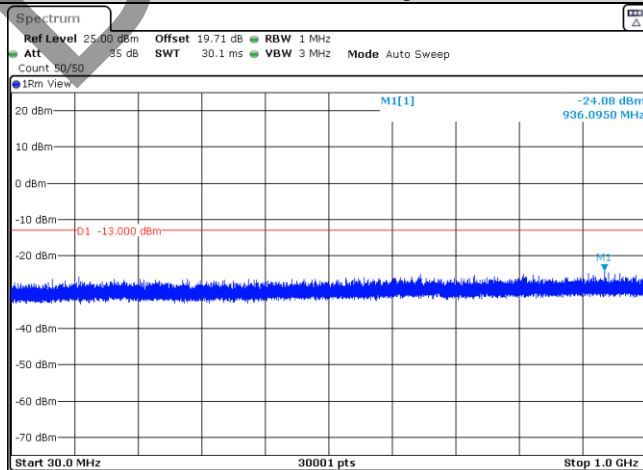

Date: 4.MAR.2024 10:35:09

Band2-10MHz-16QAM-19150-1-0-High-30-1000--24.08-PASS

BV 7Layers Communications Technology (Shenzhen) Co., Ltd

Room B37, Warehouse A5, No.3 Chiwan 4th Road, Zhaoshang Street, Nanshan District Shenzhen, Guangdong, People's Republic of China

Tel: +86 755 8869 6566

Fax: +86 755 8869 6577

Email: customerservice.sw@bureauveritas.com



BUREAU VERITAS

Test Report No.: W7L-P23120015R102

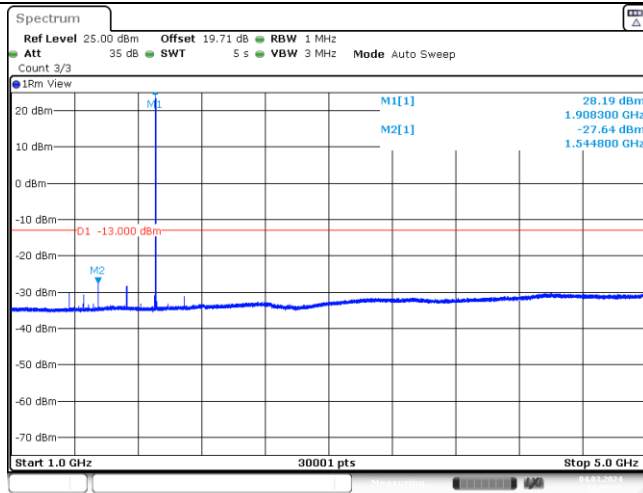

Band2-10MHz-16QAM-19150-1-0-High-1000-5000--27.64-PASS

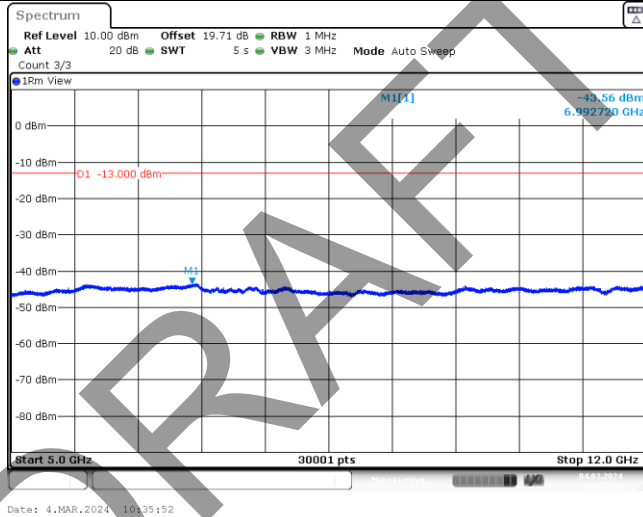

Band2-10MHz-16QAM-19150-1-0-High-5000-12000--43.56-PASS

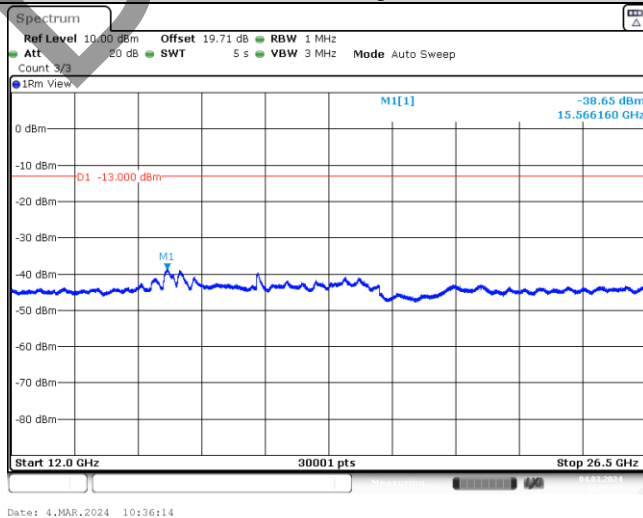

Band2-10MHz-16QAM-19150-1-0-High-12000-26500--38.65-PASS



BUREAU VERITAS

Test Report No.: W7L-P23120015R102

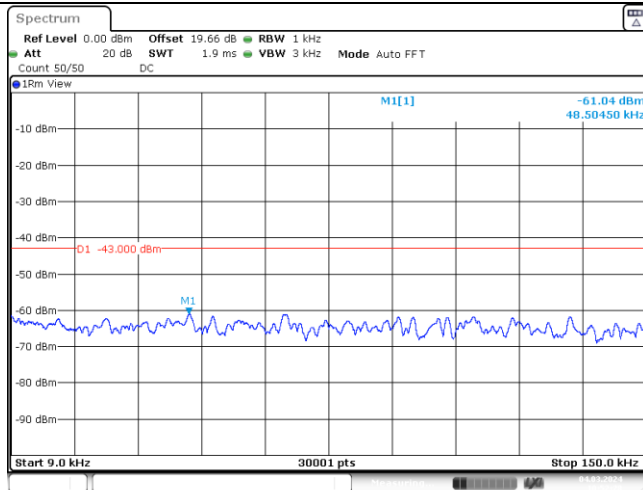

Date: 4.MAR.2024 10:52:28

Band2-15MHz-QPSK-18675-1-0-Low-0.009-0.15--61.04-PASS

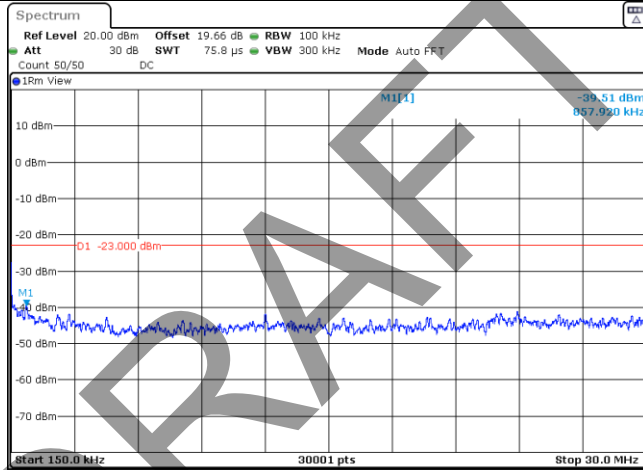

Date: 4.MAR.2024 10:52:32

Band2-15MHz-QPSK-18675-1-0-Low-0.15-30--39.51-PASS

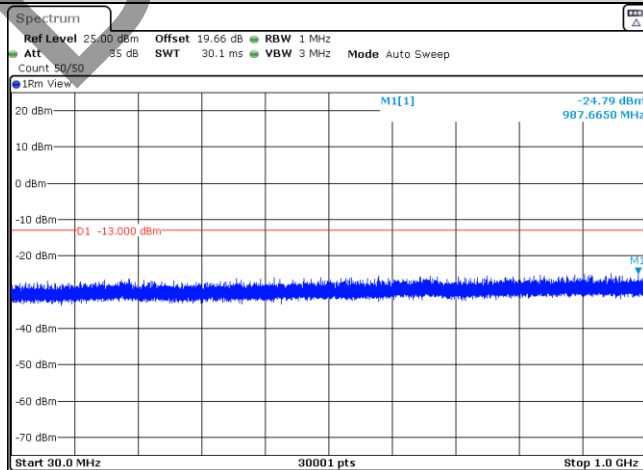

Date: 4.MAR.2024 10:52:39

Band2-15MHz-QPSK-18675-1-0-Low-30-1000--24.79-PASS

BV 7Layers Communications Technology (Shenzhen) Co., Ltd

Room B37, Warehouse A5, No.3 Chiwan 4th Road, Zhaoshang Street, Nanshan District Shenzhen, Guangdong, People's Republic of China

Tel: +86 755 8869 6566 Fax: +86 755 8869 6577

Email: customerservice.sw@bureauveritas.com



BUREAU VERITAS

Test Report No.: W7L-P23120015R102

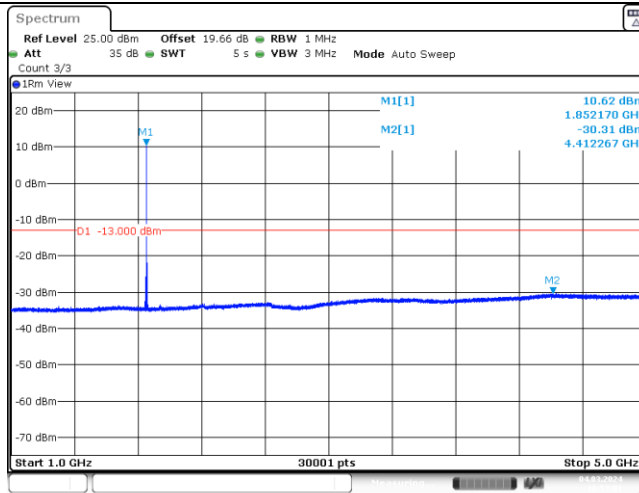

Band2-15MHz-QPSK-18675-1-0-Low-1000-5000--30.31-PASS

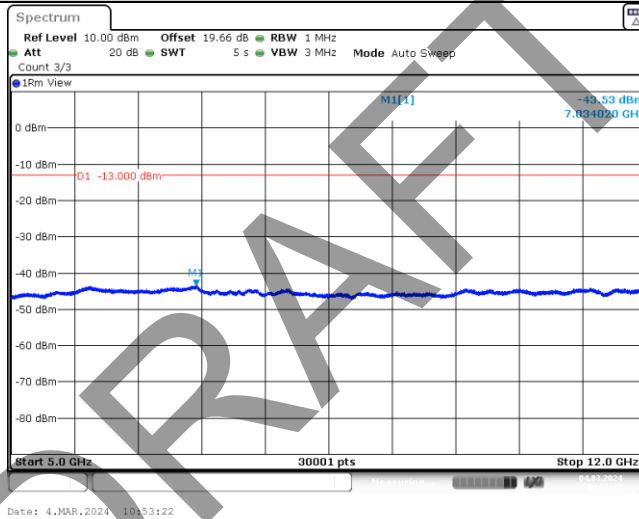

Band2-15MHz-QPSK-18675-1-0-Low-5000-12000--43.53-PASS

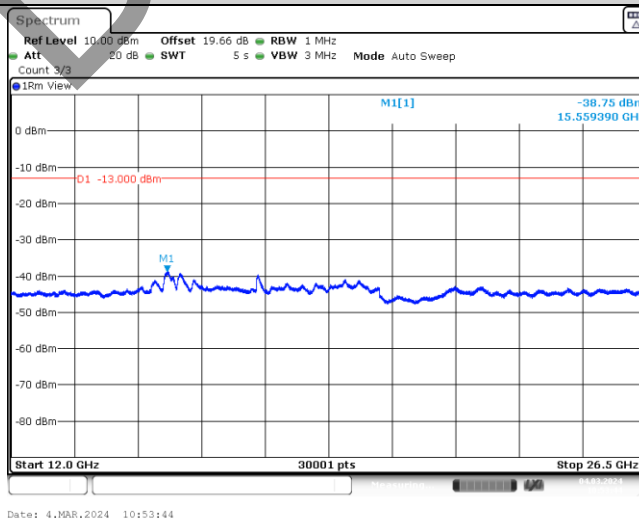

Band2-15MHz-QPSK-18675-1-0-Low-12000-26500--38.75-PASS

BV 7Layers Communications Technology (Shenzhen) Co., Ltd

Room B37, Warehouse A5, No.3 Chiwan 4th Road, Zhaoshang Street, Nanshan District Shenzhen, Guangdong, People's Republic of China

Tel: +86 755 8869 6566 Fax: +86 755 8869 6577

Email: customerservice.sw@bureauveritas.com



BUREAU VERITAS

Test Report No.: W7L-P23120015R102

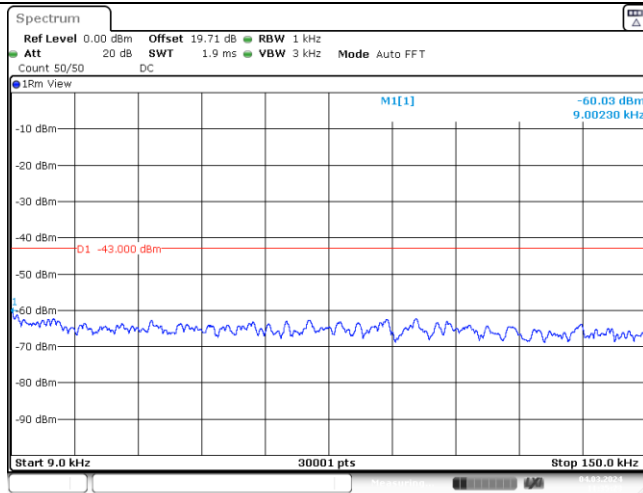

Date: 4.MAR.2024 11:35:23

Band2-15MHz-QPSK-18900-1-0-Low-0.009-0.15--60.03-PASS

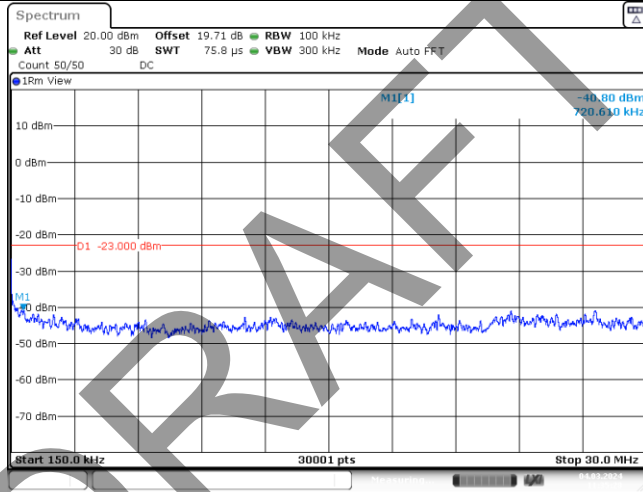

Date: 4.MAR.2024 11:35:28

Band2-15MHz-QPSK-18900-1-0-Low-0.15-30--40.8-PASS

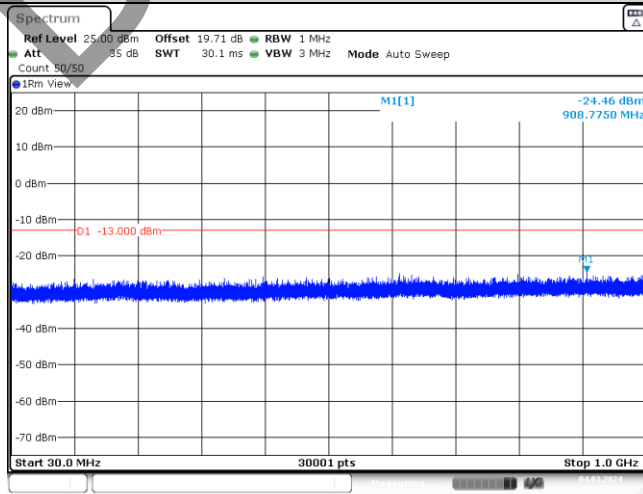

Date: 4.MAR.2024 11:35:35

Band2-15MHz-QPSK-18900-1-0-Low-30-1000--24.46-PASS

BV 7Layers Communications Technology (Shenzhen) Co., Ltd

Room B37, Warehouse A5, No.3 Chiwan 4th Road, Zhaoshang Street, Nanshan District Shenzhen, Guangdong, People's Republic of China

Tel: +86 755 8869 6566
 Fax: +86 755 8869 6577
 Email: customerservice.sw@bureauveritas.com



BUREAU VERITAS

Test Report No.: W7L-P23120015R102

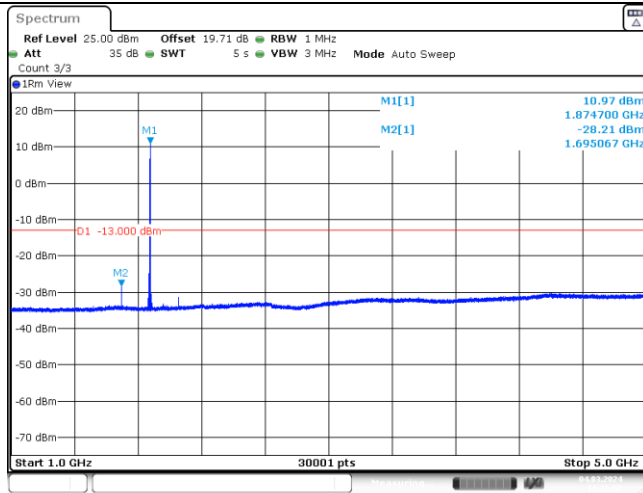

Band2-15MHz-QPSK-18900-1-0-Low-1000-5000--28.21-PASS

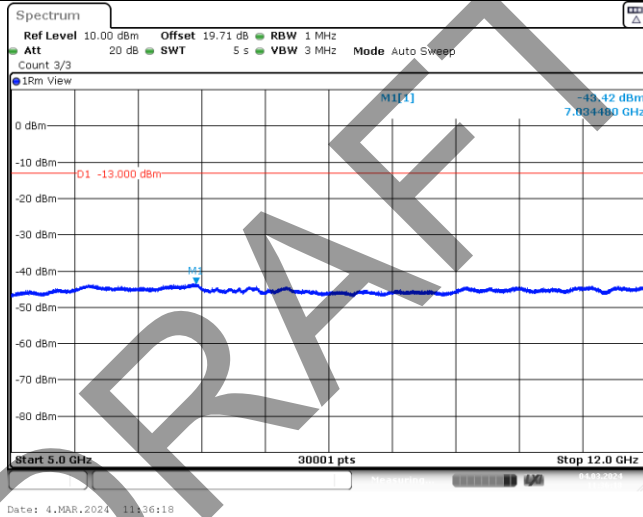

Band2-15MHz-QPSK-18900-1-0-Low-5000-12000--43.42-PASS

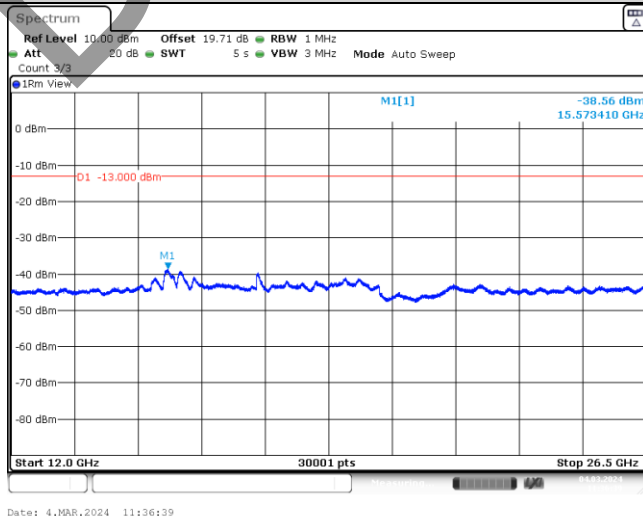

Band2-15MHz-QPSK-18900-1-0-Low-12000-26500--38.56-PASS

BV 7Layers Communications Technology (Shenzhen) Co., Ltd

Room B37, Warehouse A5, No.3 Chiwan 4th Road, Zhaoshang Street, Nanshan District Shenzhen, Guangdong, People's Republic of China

Tel: +86 755 8869 6566 Fax: +86 755 8869 6577 Email: customerservice.sw@bureauveritas.com



BUREAU VERITAS

Test Report No.: W7L-P23120015R102

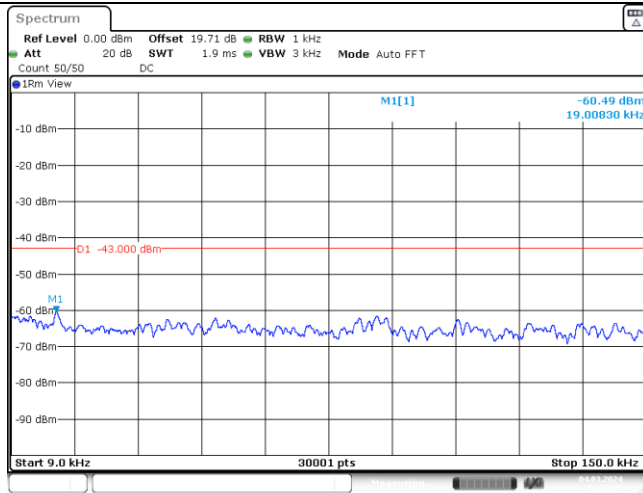

Band2-15MHz-QPSK-19125-1-0-High-0.009-0.15--60.49-PASS

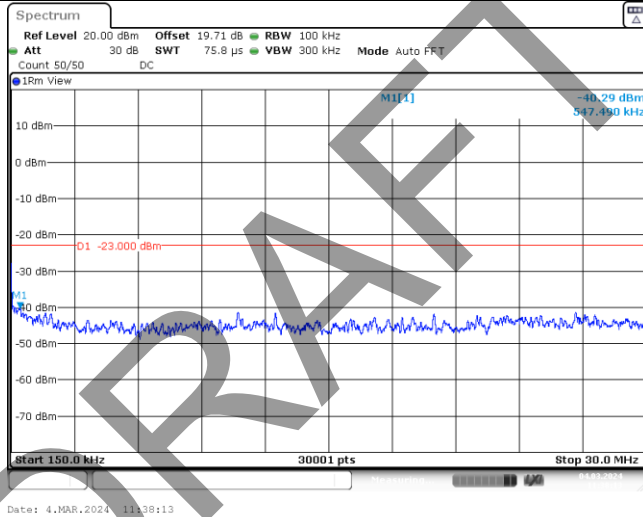

Band2-15MHz-QPSK-19125-1-0-High-0.15-30--40.29-PASS

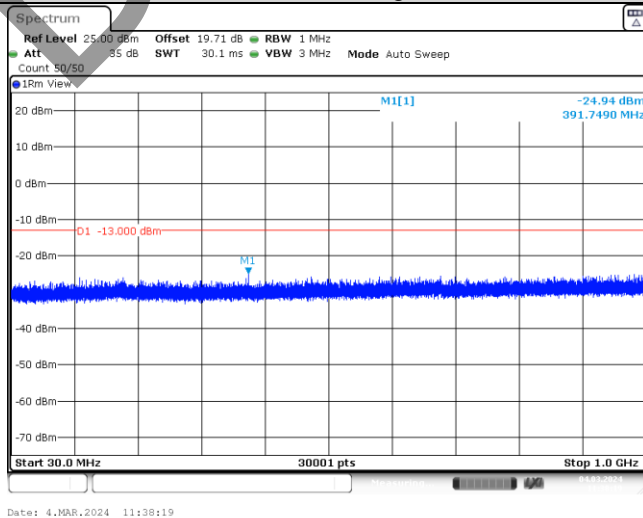

Band2-15MHz-QPSK-19125-1-0-High-30-1000--24.94-PASS

BV 7Layers Communications Technology (Shenzhen) Co., Ltd

Room B37, Warehouse A5, No.3 Chiwan 4th Road, Zhaoshang Street, Nanshan District Shenzhen, Guangdong, People's Republic of China

Tel: +86 755 8869 6566 Fax: +86 755 8869 6577

Email: customerservice.sw@bureauveritas.com



BUREAU VERITAS

Test Report No.: W7L-P23120015R102

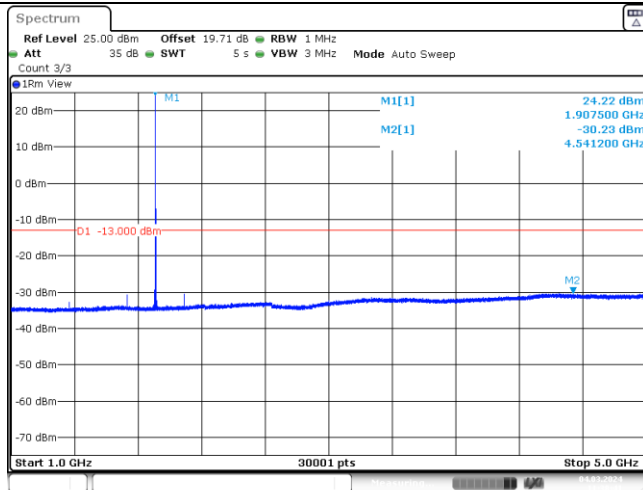

Date: 4.MAR.2024 11:38:41

Band2-15MHz-QPSK-19125-1-0-High-1000-5000--30.23-PASS

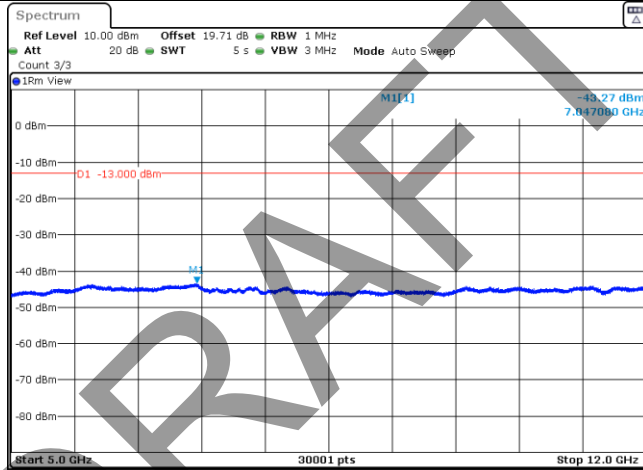

Date: 4.MAR.2024 11:39:03

Band2-15MHz-QPSK-19125-1-0-High-5000-12000--43.27-PASS

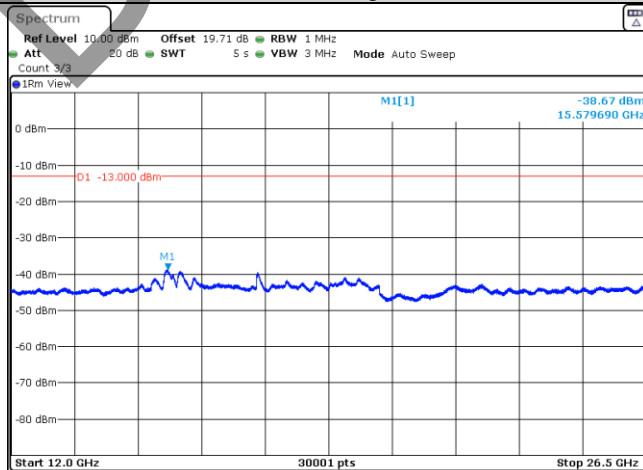

Date: 4.MAR.2024 11:39:24

Band2-15MHz-QPSK-19125-1-0-High-12000-26500--38.67-PASS

BV 7Layers Communications Technology (Shenzhen) Co., Ltd

Room B37, Warehouse A5, No.3 Chiwan 4th Road, Zhaoshang Street, Nanshan District Shenzhen, Guangdong, People's Republic of China

Tel: +86 755 8869 6566 Fax: +86 755 8869 6577

Email: customerservice.sw@bureauveritas.com



BUREAU VERITAS

Test Report No.: W7L-P23120015R102

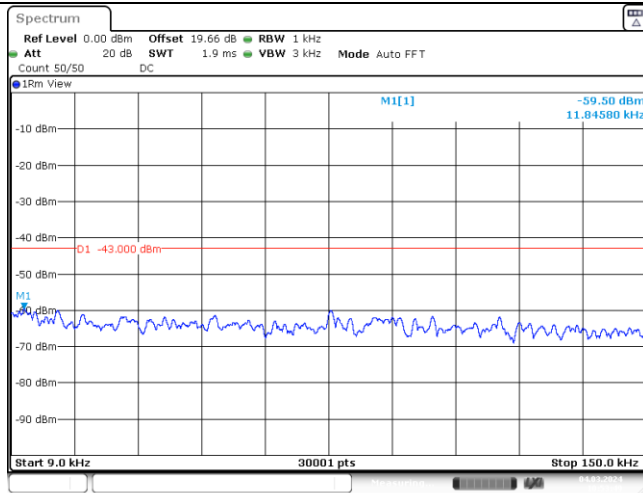

Band2-15MHz-16QAM-18675-1-0-Low-0.15--59.5-PASS

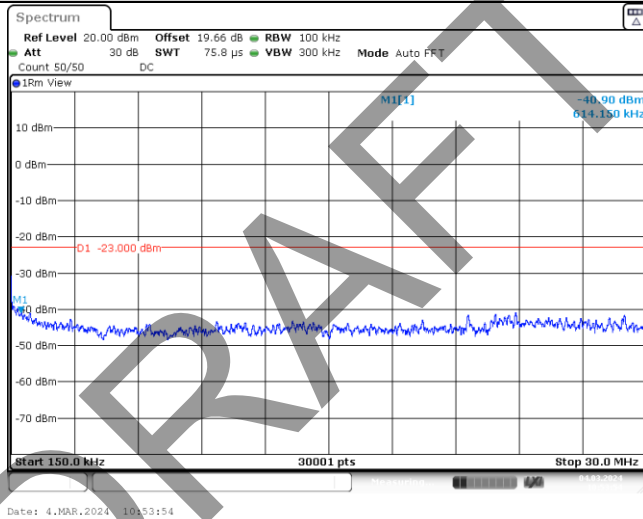

Band2-15MHz-16QAM-18675-1-0-Low-0.15-30--40.9-PASS

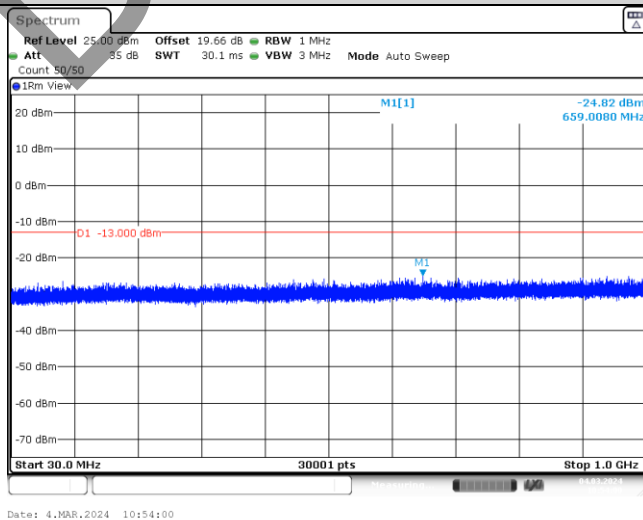

Band2-15MHz-16QAM-18675-1-0-Low-30-1000--24.82-PASS

BV 7Layers Communications Technology (Shenzhen) Co., Ltd

Room B37, Warehouse A5, No.3 Chiwan 4th Road, Zhaoshang Street, Nanshan District Shenzhen, Guangdong, People's Republic of China

Tel: +86 755 8869 6566
 Fax: +86 755 8869 6577
 Email: customerservice.sw@bureauveritas.com



BUREAU VERITAS

Test Report No.: W7L-P23120015R102

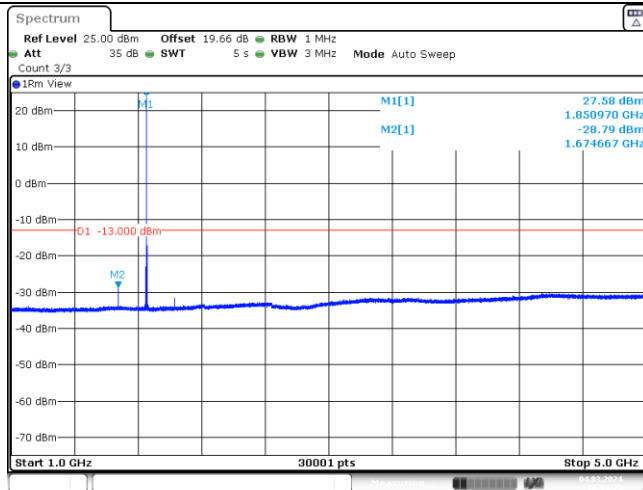

Date: 4.MAR.2024 10:54:23

Band2-15MHz-16QAM-18675-1-0-Low-1000-5000--28.79-PASS

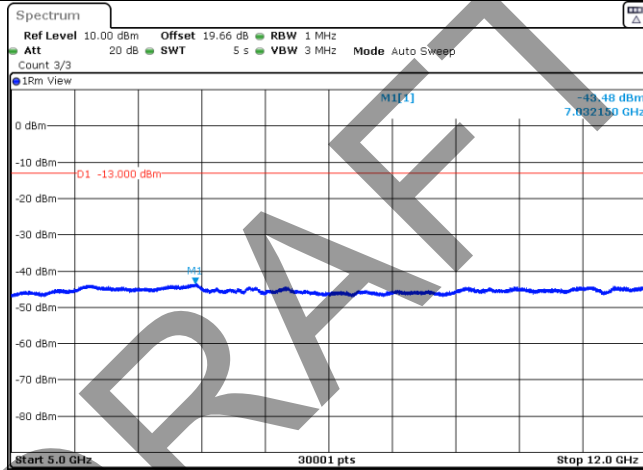

Date: 4.MAR.2024 10:54:44

Band2-15MHz-16QAM-18675-1-0-Low-5000-12000--43.48-PASS

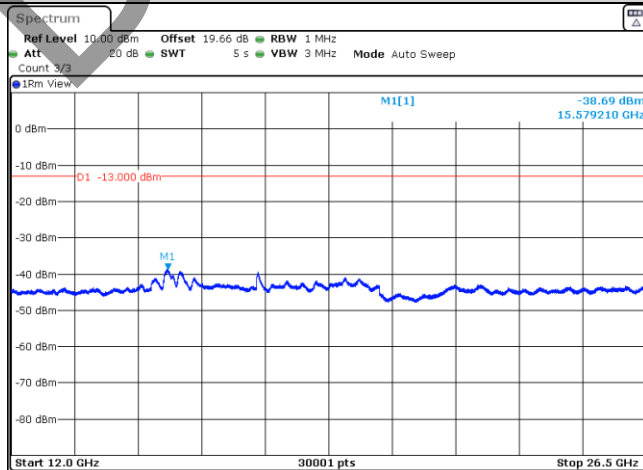

Date: 4.MAR.2024 10:55:05

Band2-15MHz-16QAM-18675-1-0-Low-12000-26500--38.69-PASS

BV 7Layers Communications Technology (Shenzhen) Co., Ltd

Room B37, Warehouse A5, No.3 Chiwan 4th Road, Zhaoshang Street, Nanshan District Shenzhen, Guangdong, People's Republic of China

Tel: +86 755 8869 6566 Fax: +86 755 8869 6577

Email: customerservice.sw@bureauveritas.com



BUREAU VERITAS

Test Report No.: W7L-P23120015R102

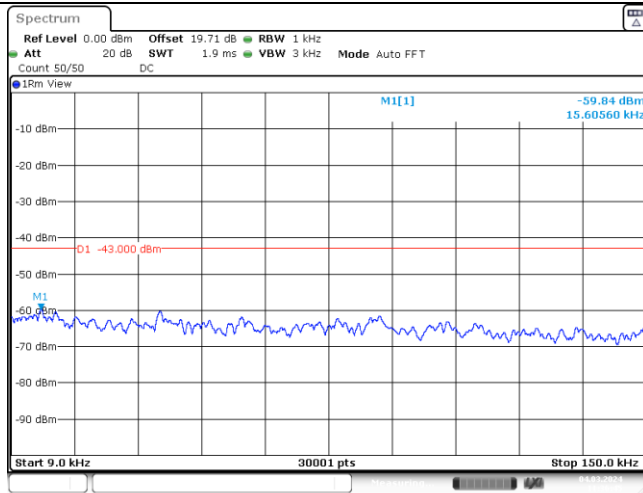

Band2-15MHz-16QAM-18900-1-0-Low-0.009-0.15--59.84-PASS

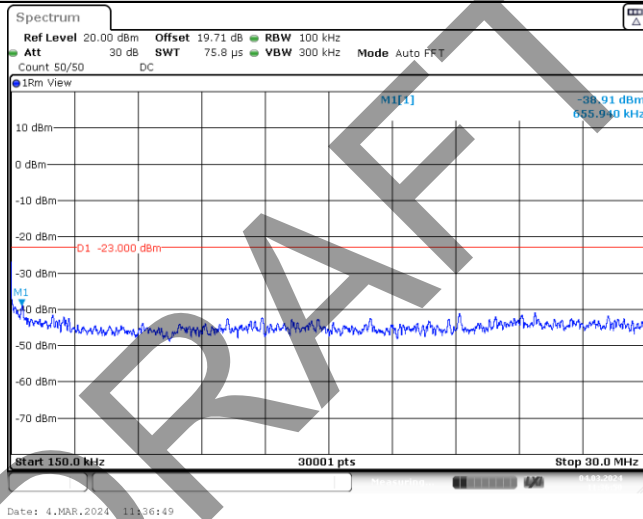

Band2-15MHz-16QAM-18900-1-0-Low-0.15-30--38.91-PASS

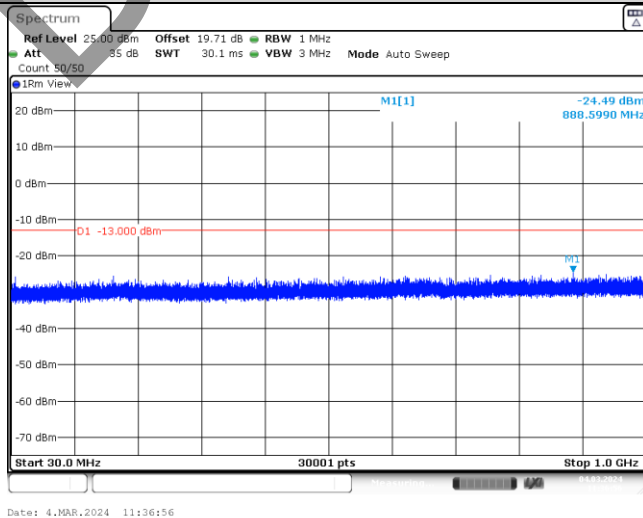

Band2-15MHz-16QAM-18900-1-0-Low-30-1000--24.49-PASS

BV 7Layers Communications Technology (Shenzhen) Co., Ltd

Room B37, Warehouse A5, No.3 Chiwan 4th Road, Zhaoshang Street, Nanshan District Shenzhen, Guangdong, People's Republic of China

Tel: +86 755 8869 6566
 Fax: +86 755 8869 6577
 Email: customerservice.sw@bureauveritas.com



BUREAU VERITAS

Test Report No.: W7L-P23120015R102

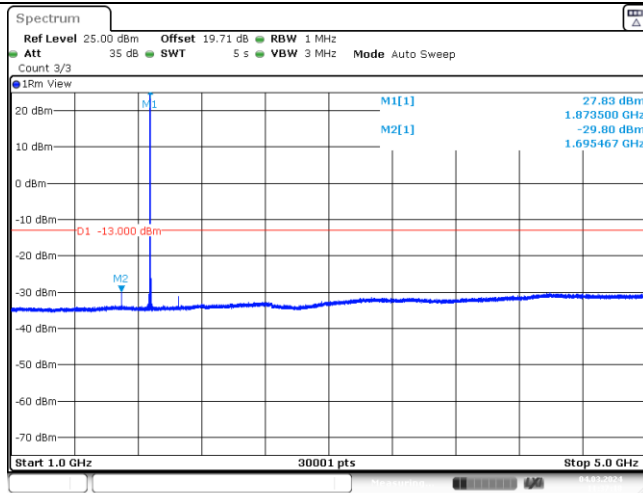

Date: 4.MAR.2024 11:37:18

Band2-15MHz-16QAM-18900-1-0-Low-1000-5000--29.8-PASS

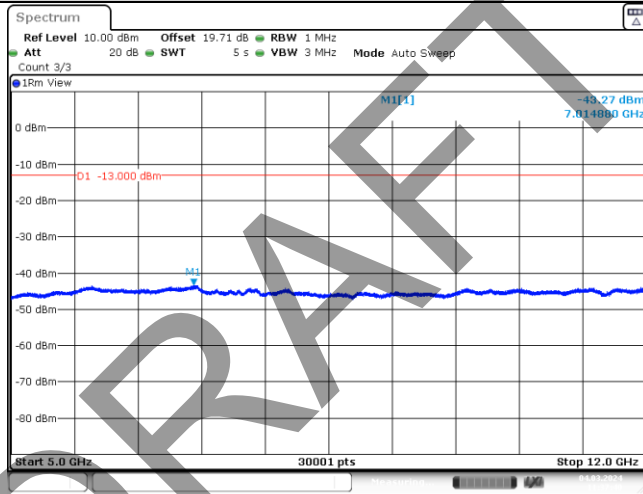

Date: 4.MAR.2024 11:37:40

Band2-15MHz-16QAM-18900-1-0-Low-5000-12000--43.27-PASS

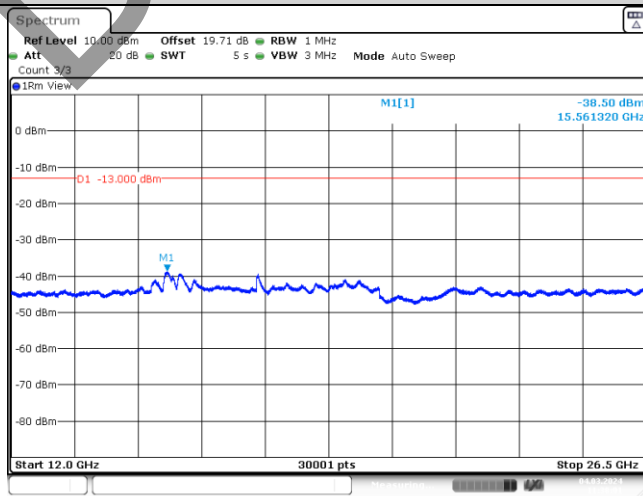

Date: 4.MAR.2024 11:38:01

Band2-15MHz-16QAM-18900-1-0-Low-12000-26500--38.5-PASS

BV 7Layers Communications Technology (Shenzhen) Co., Ltd

Room B37, Warehouse A5, No.3 Chiwan 4th Road, Zhaoshang Street, Nanshan District Shenzhen, Guangdong, People's Republic of China

Tel: +86 755 8869 6566 Fax: +86 755 8869 6577 Email: customerservice.sw@bureauveritas.com



BUREAU VERITAS

Test Report No.: W7L-P23120015R102

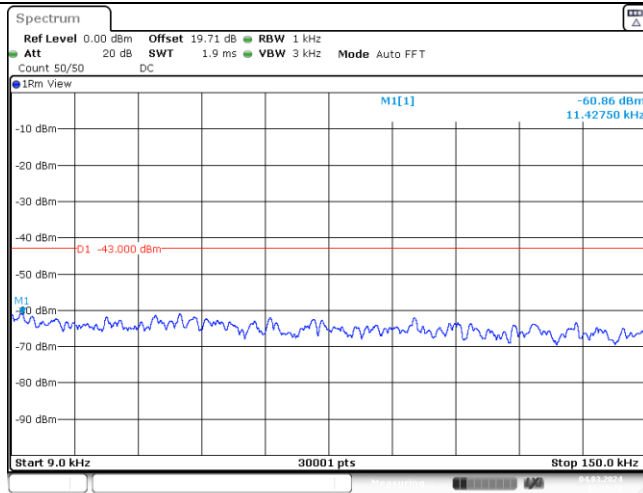

Band2-15MHz-16QAM-19125-1-0-High-0.009-0.15--60.86-PASS

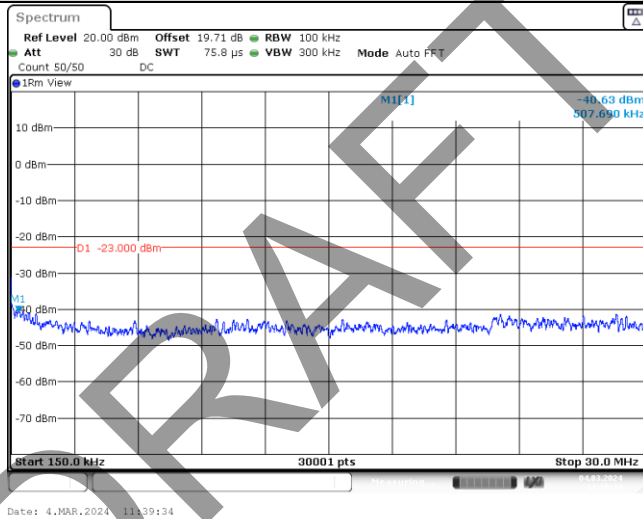

Band2-15MHz-16QAM-19125-1-0-High-0.15-30--40.63-PASS

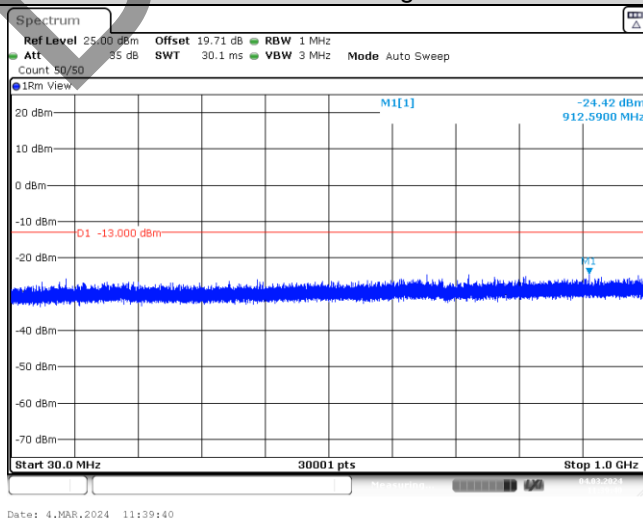

Band2-15MHz-16QAM-19125-1-0-High-30-1000--24.42-PASS



BUREAU VERITAS

Test Report No.: W7L-P23120015R102

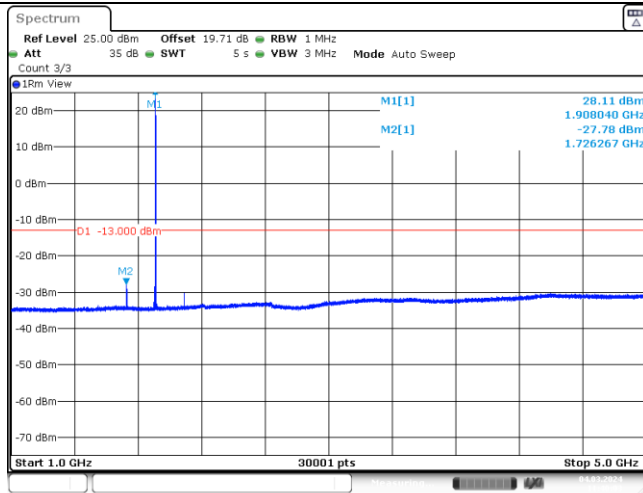

Date: 4.MAR.2024 11:40:03

Band2-15MHz-16QAM-19125-1-0-High-1000-5000--27.78-PASS

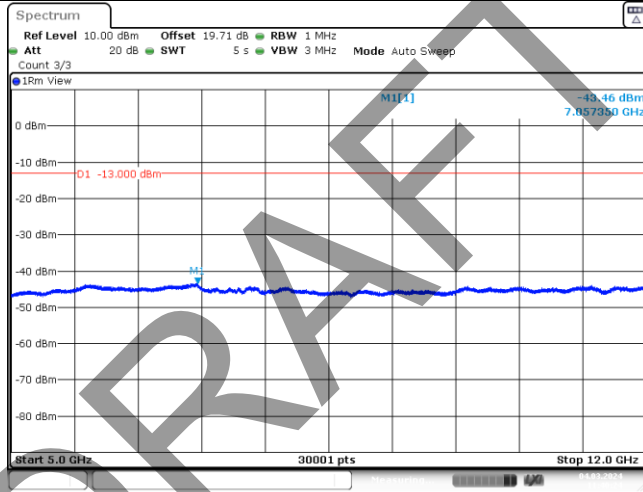

Date: 4.MAR.2024 11:40:24

Band2-15MHz-16QAM-19125-1-0-High-5000-12000--43.46-PASS

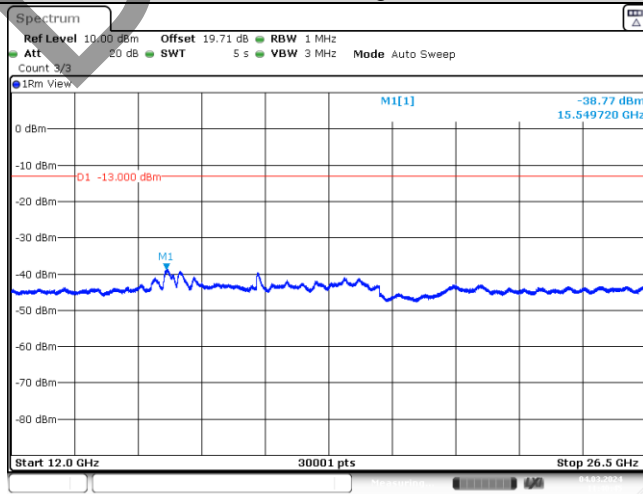

Date: 4.MAR.2024 11:40:45

Band2-15MHz-16QAM-19125-1-0-High-12000-26500--38.77-PASS

BV 7Layers Communications Technology (Shenzhen) Co., Ltd

Room B37, Warehouse A5, No.3 Chiwan 4th Road, Zhaoshang Street, Nanshan District Shenzhen, Guangdong, People's Republic of China

Tel: +86 755 8869 6566 Fax: +86 755 8869 6577

Email: customerservice.sw@bureauveritas.com



BUREAU VERITAS

Test Report No.: W7L-P23120015R102

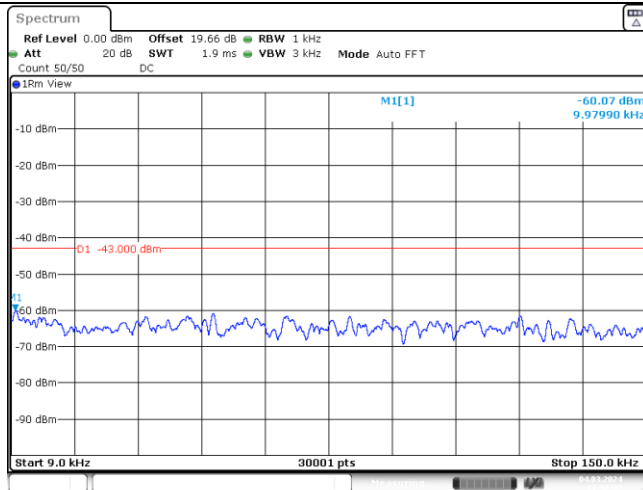

Date: 4.MAR.2024 11:57:07

Band2-20MHz-QPSK-18700-1-0-Low-0.009-0.15--60.07-PASS

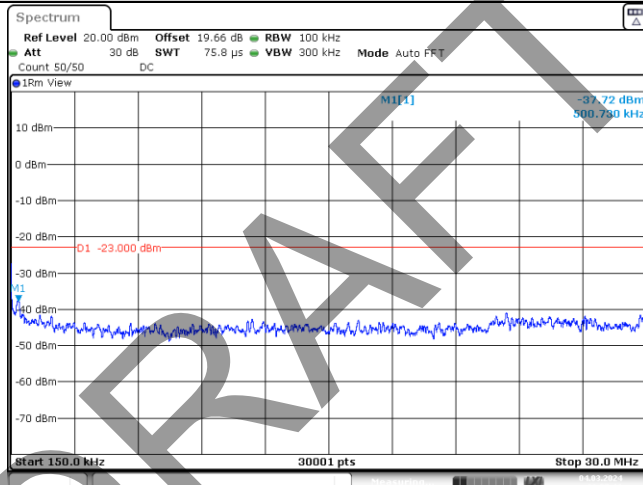

Date: 4.MAR.2024 11:57:11

Band2-20MHz-QPSK-18700-1-0-Low-0.15-30--37.72-PASS

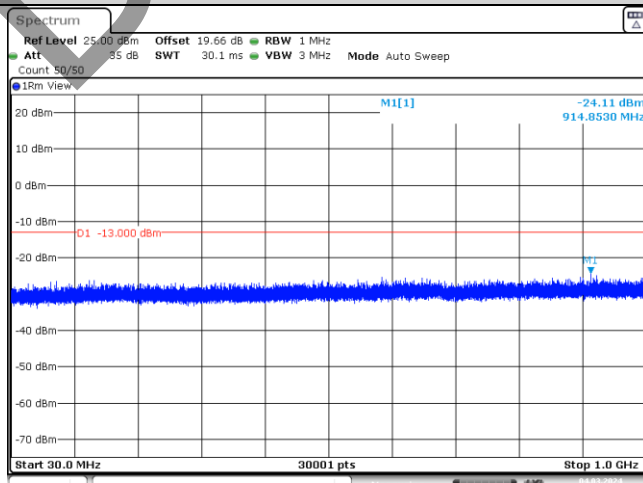

Date: 4.MAR.2024 11:57:18

Band2-20MHz-QPSK-18700-1-0-Low-30-1000--24.11-PASS

BV 7Layers Communications Technology (Shenzhen) Co., Ltd

Room B37, Warehouse A5, No.3 Chiwan 4th Road, Zhaoshang Street, Nanshan District Shenzhen, Guangdong, People's Republic of China

Tel: +86 755 8869 6566 Fax: +86 755 8869 6577

Email: customerservice.sw@bureauveritas.com



BUREAU VERITAS

Test Report No.: W7L-P23120015R102

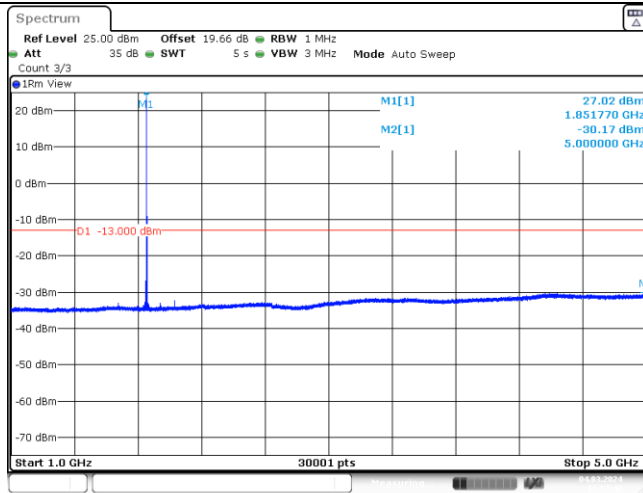

Band2-20MHz-QPSK-18700-1-0-Low-1000-5000--30.17-PASS

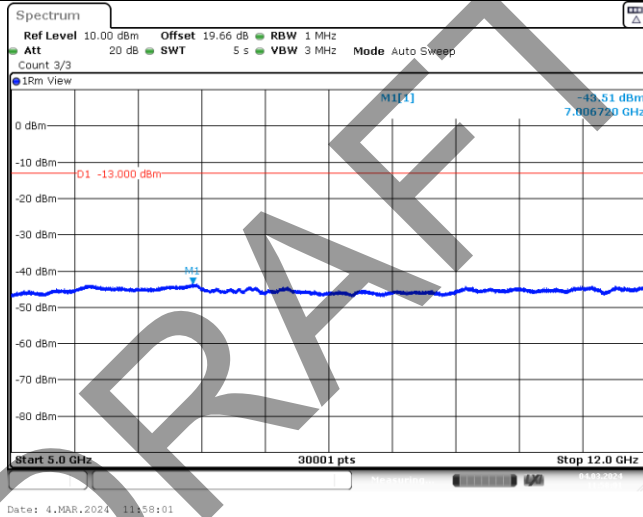

Band2-20MHz-QPSK-18700-1-0-Low-5000-12000--43.51-PASS

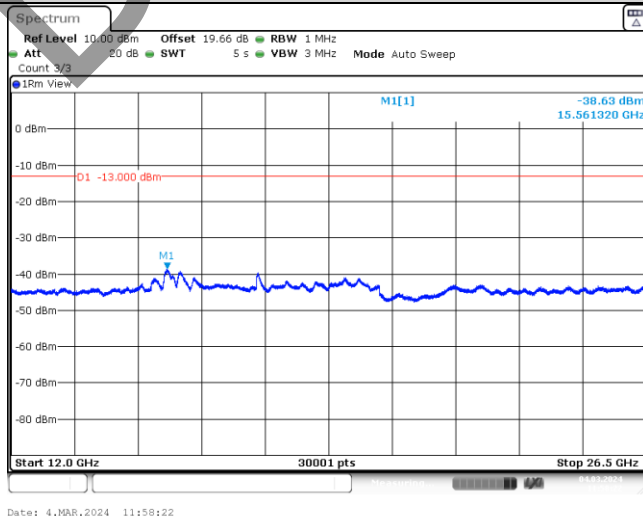

Band2-20MHz-QPSK-18700-1-0-Low-12000-26500--38.63-PASS

BV 7Layers Communications Technology (Shenzhen) Co., Ltd

Room B37, Warehouse A5, No.3 Chiwan 4th Road, Zhaoshang Street, Nanshan District Shenzhen, Guangdong, People's Republic of China

Tel: +86 755 8869 6566 Fax: +86 755 8869 6577 Email: customerservice.sw@bureauveritas.com



BUREAU VERITAS

Test Report No.: W7L-P23120015R102

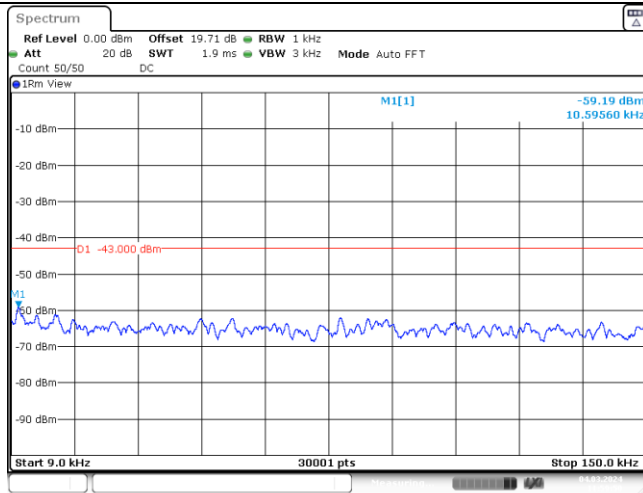

Band2-20MHz-QPSK-18900-1-0-Low-0.009-0.15--59.19-PASS

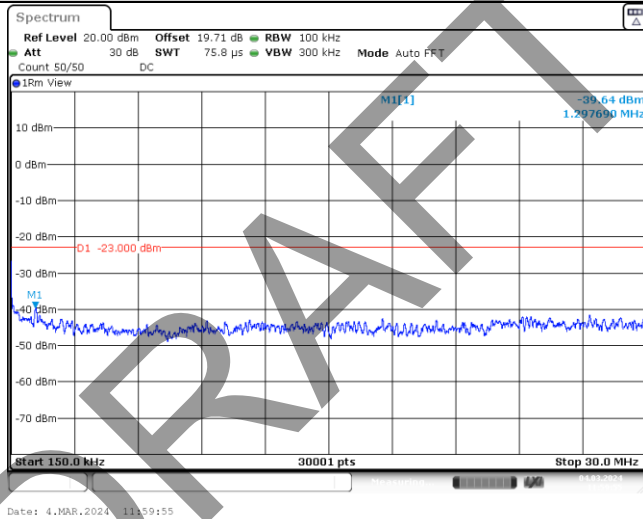

Band2-20MHz-QPSK-18900-1-0-Low-0.15-30--39.64-PASS

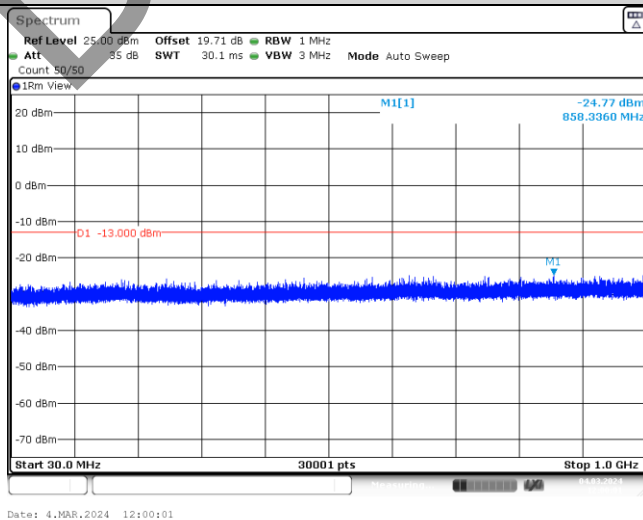

Band2-20MHz-QPSK-18900-1-0-Low-30-1000--24.77-PASS

BV 7Layers Communications Technology (Shenzhen) Co., Ltd

Room B37, Warehouse A5, No.3 Chiwan 4th Road, Zhaoshang Street, Nanshan District Shenzhen, Guangdong, People's Republic of China

Tel: +86 755 8869 6566
 Fax: +86 755 8869 6577
 Email: customerservice.sw@bureauveritas.com



BUREAU VERITAS

Test Report No.: W7L-P23120015R102

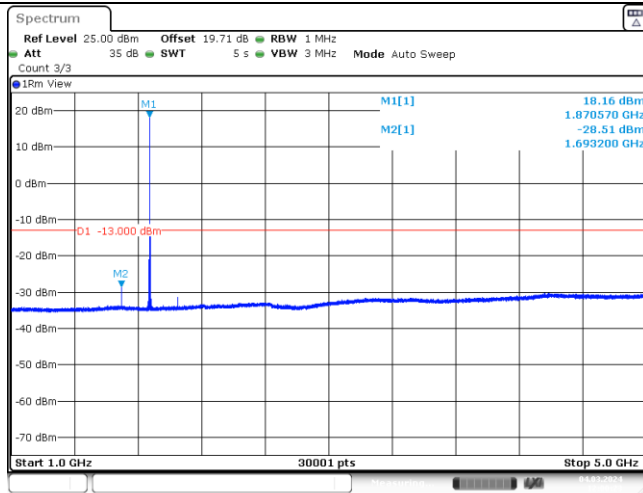

Band2-20MHz-QPSK-18900-1-0-Low-1000-5000--28.51-PASS

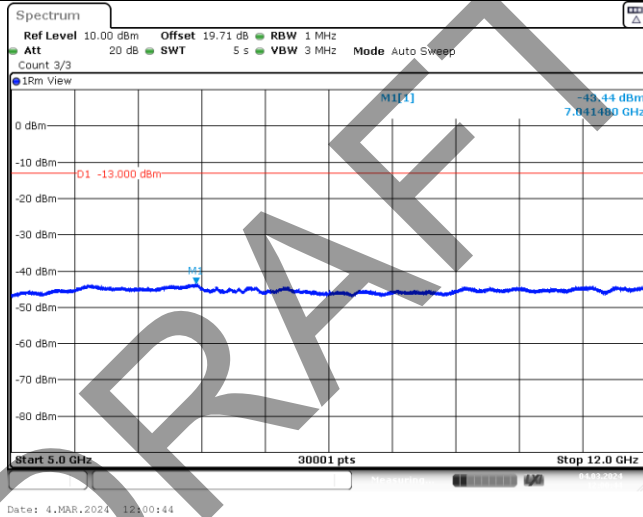

Band2-20MHz-QPSK-18900-1-0-Low-5000-12000--43.44-PASS

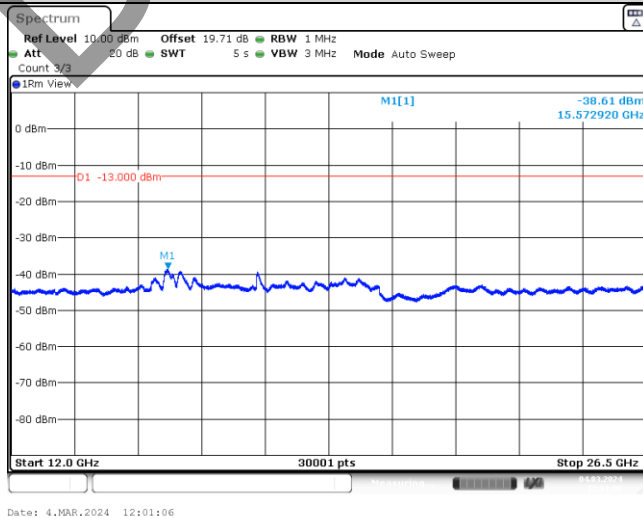

Band2-20MHz-QPSK-18900-1-0-Low-12000-26500--38.61-PASS

BV 7Layers Communications Technology (Shenzhen) Co., Ltd

Room B37, Warehouse A5, No.3 Chiwan 4th Road, Zhaoshang Street, Nanshan District Shenzhen, Guangdong, People's Republic of China

Tel: +86 755 8869 6566
 Fax: +86 755 8869 6577
 Email: customerservice.sw@bureauveritas.com



BUREAU VERITAS

Test Report No.: W7L-P23120015R102

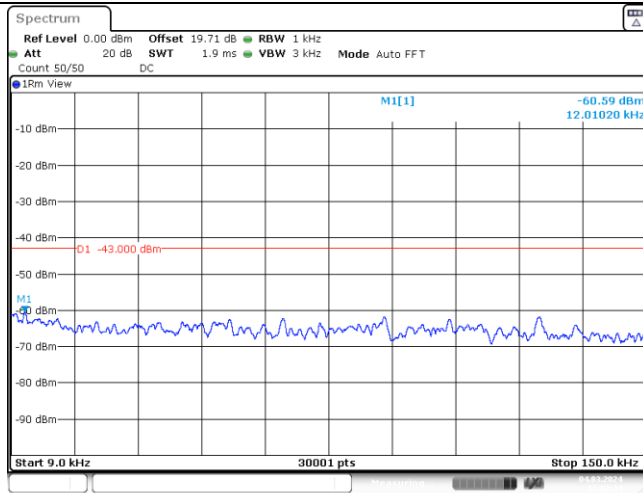

Band2-20MHz-QPSK-19100-1-0-High-0.009-0.15--60.59-PASS

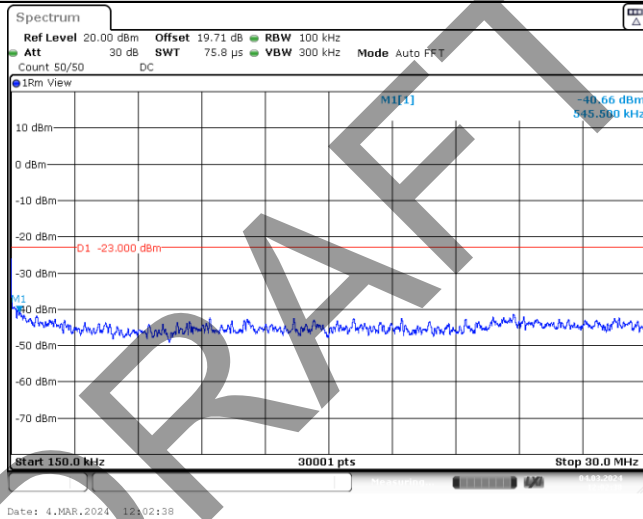

Band2-20MHz-QPSK-19100-1-0-High-0.15-30--40.66-PASS

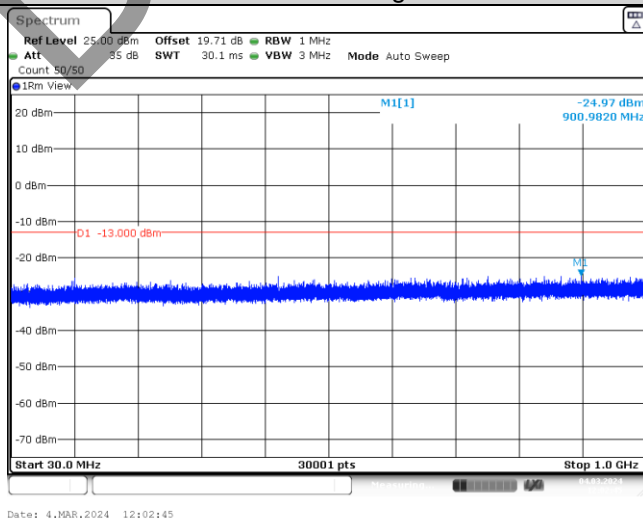

Band2-20MHz-QPSK-19100-1-0-High-30-1000--24.97-PASS

BV 7Layers Communications Technology (Shenzhen) Co., Ltd

Room B37, Warehouse A5, No.3 Chiwan 4th Road, Zhaoshang Street, Nanshan District Shenzhen, Guangdong, People's Republic of China

Tel: +86 755 8869 6566 Fax: +86 755 8869 6577

Email: customerservice.sw@bureauveritas.com



BUREAU VERITAS

Test Report No.: W7L-P23120015R102

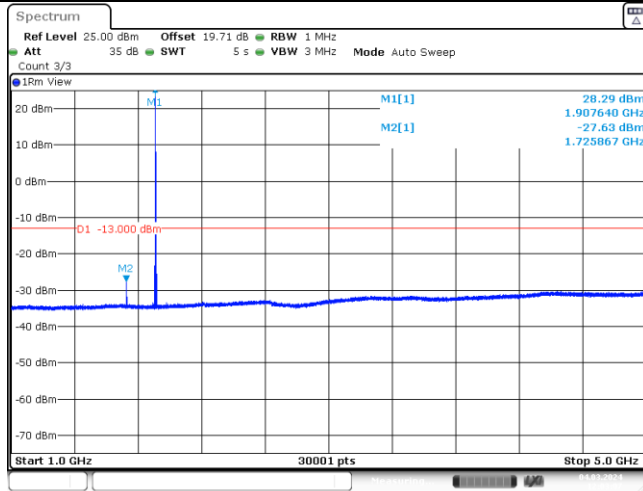

Date: 4.MAR.2024 12:03:07

Band2-20MHz-QPSK-19100-1-0-High-1000-5000--27.63-PASS

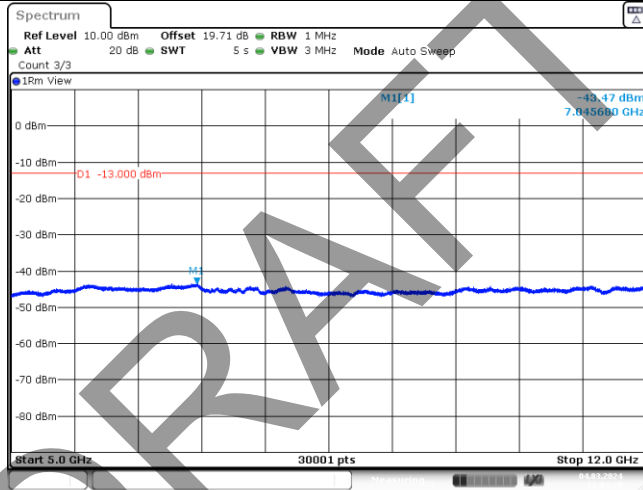

Date: 4.MAR.2024 12:03:28

Band2-20MHz-QPSK-19100-1-0-High-5000-12000--43.47-PASS

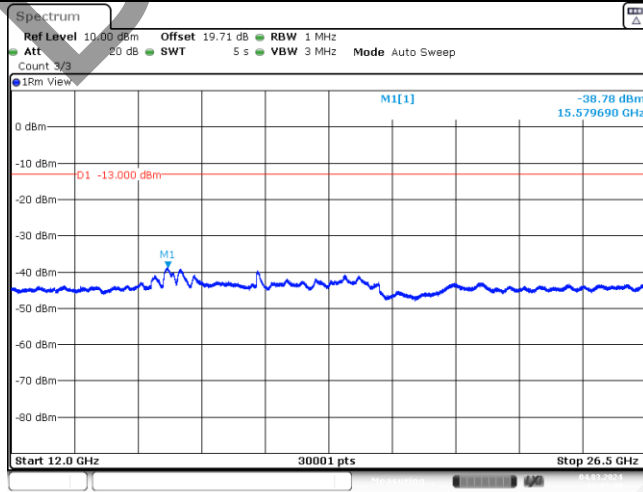

Date: 4.MAR.2024 12:03:49

Band2-20MHz-QPSK-19100-1-0-High-12000-26500--38.78-PASS

BV 7Layers Communications Technology (Shenzhen) Co., Ltd

Room B37, Warehouse A5, No.3 Chiwan 4th Road, Zhaoshang Street, Nanshan District Shenzhen, Guangdong, People's Republic of China

Tel: +86 755 8869 6566 Fax: +86 755 8869 6577

Email: customerservice.sw@bureauveritas.com



BUREAU VERITAS

Test Report No.: W7L-P23120015R102

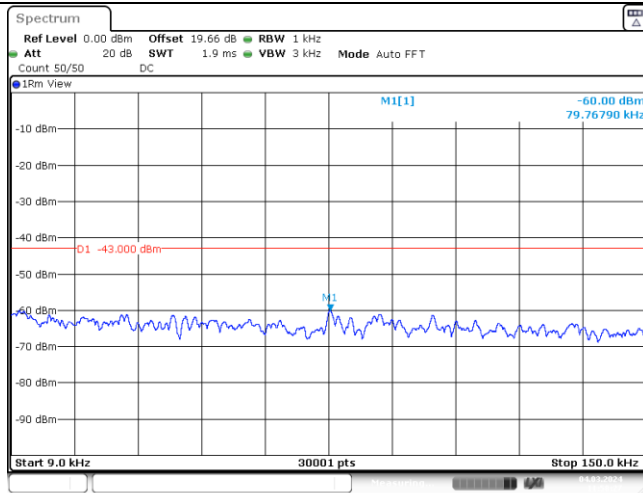

Band2-20MHz-16QAM-18700-1-0-Low-0.15--60-PASS

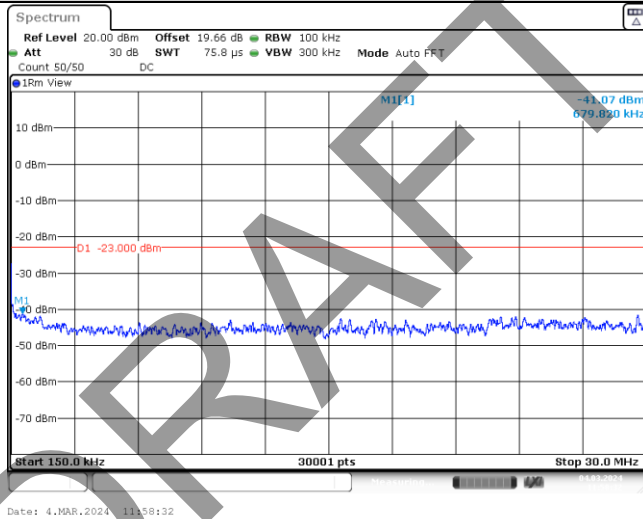

Band2-20MHz-16QAM-18700-1-0-Low-0.15-30--41.07-PASS

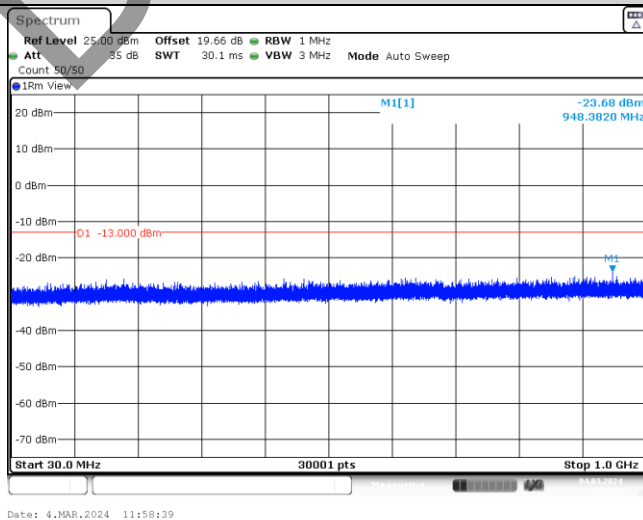

Band2-20MHz-16QAM-18700-1-0-Low-30-1000--23.68-PASS



BUREAU VERITAS

Test Report No.: W7L-P23120015R102

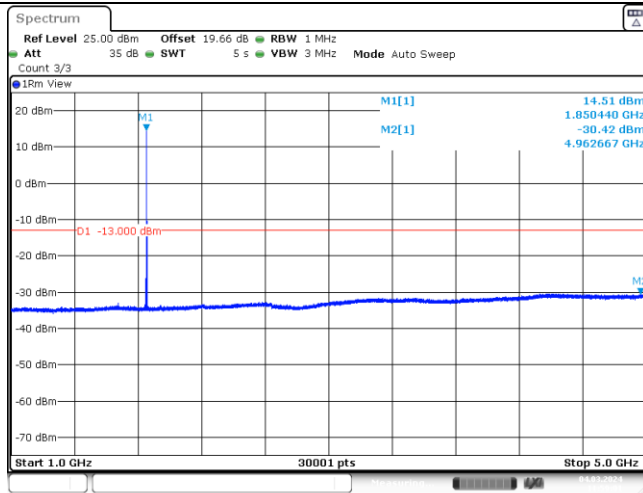

Band2-20MHz-16QAM-18700-1-0-Low-1000-5000--30.42-PASS



Band2-20MHz-16QAM-18700-1-0-Low-5000-12000--43.29-PASS

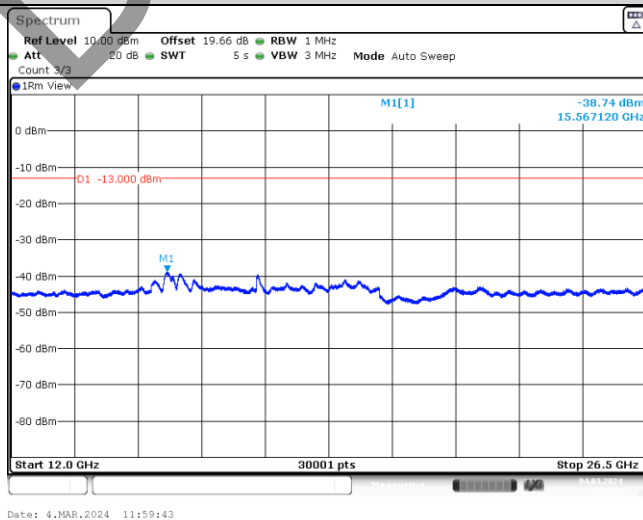

Band2-20MHz-16QAM-18700-1-0-Low-12000-26500--38.74-PASS

BV 7Layers Communications Technology (Shenzhen) Co., Ltd

Room B37, Warehouse A5, No.3 Chiwan 4th Road, Zhaoshang Street, Nanshan District Shenzhen, Guangdong, People's Republic of China

Tel: +86 755 8869 6566 Fax: +86 755 8869 6577 Email: customerservice.sw@bureauveritas.com



BUREAU VERITAS

Test Report No.: W7L-P23120015R102

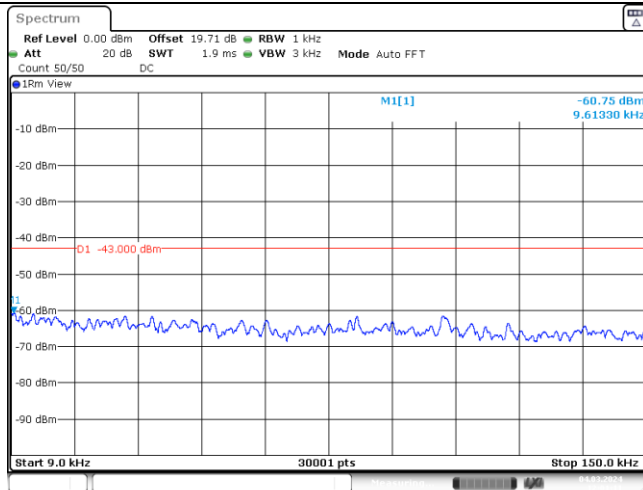

Date: 4.MAR.2024 12:01:11

Band2-20MHz-16QAM-18900-1-0-Low-0.009-0.15--60.75-PASS

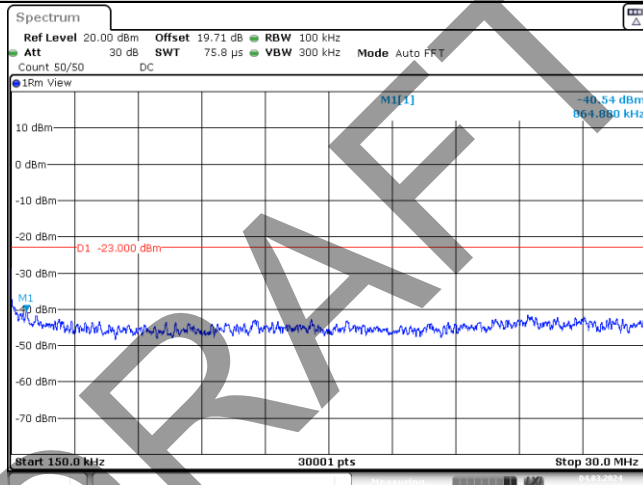

Date: 4.MAR.2024 12:01:15

Band2-20MHz-16QAM-18900-1-0-Low-0.15-30--40.54-PASS

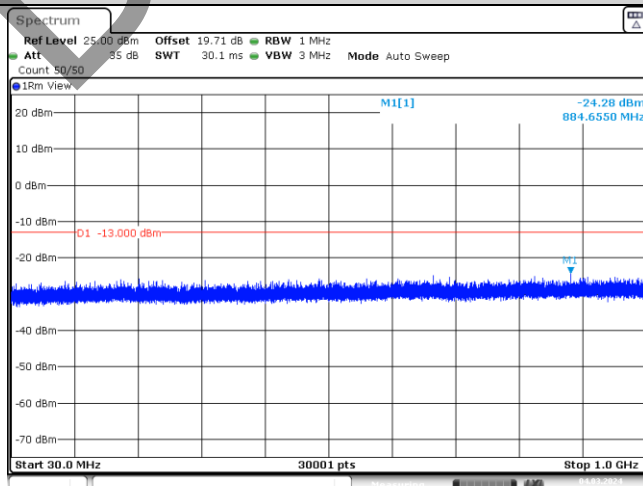

Date: 4.MAR.2024 12:01:22

Band2-20MHz-16QAM-18900-1-0-Low-30-1000--24.28-PASS

BV 7Layers Communications Technology (Shenzhen) Co., Ltd

Room B37, Warehouse A5, No.3 Chiwan 4th Road, Zhaoshang Street, Nanshan District Shenzhen, Guangdong, People's Republic of China

Tel: +86 755 8869 6566 Fax: +86 755 8869 6577

Email: customerservice.sw@bureauveritas.com



BUREAU VERITAS

Test Report No.: W7L-P23120015R102

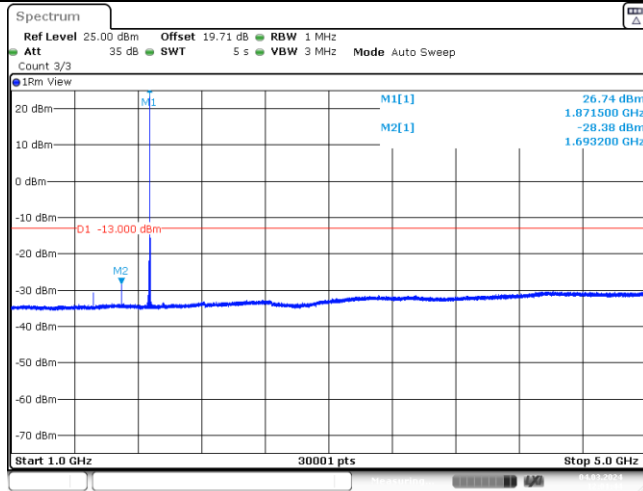

Band2-20MHz-16QAM-18900-1-0-Low-1000-5000--28.38-PASS

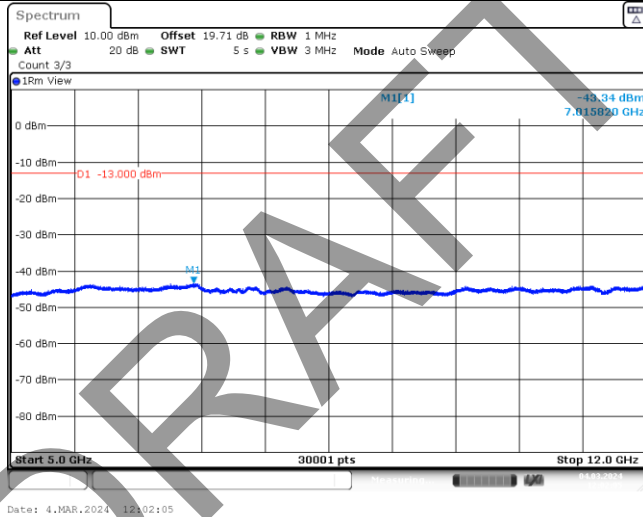

Band2-20MHz-16QAM-18900-1-0-Low-5000-12000--43.34-PASS

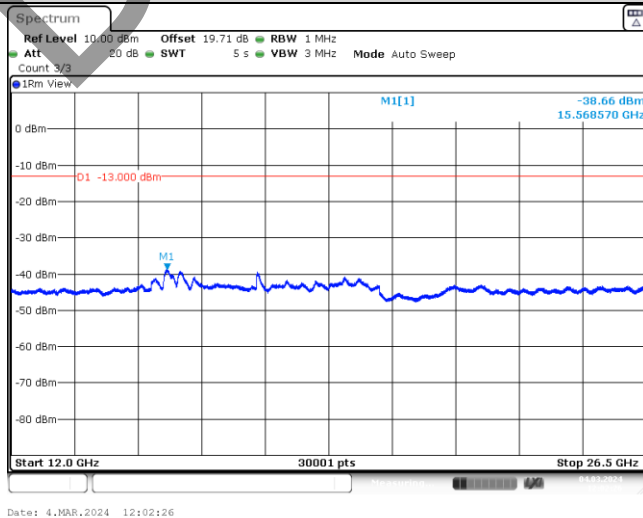

Band2-20MHz-16QAM-18900-1-0-Low-12000-26500--38.66-PASS

BV 7Layers Communications Technology (Shenzhen) Co., Ltd

Room B37, Warehouse A5, No.3 Chiwan 4th Road, Zhaoshang Street, Nanshan District Shenzhen, Guangdong, People's Republic of China

Tel: +86 755 8869 6566 Fax: +86 755 8869 6577

Email: customerservice.sw@bureauveritas.com



BUREAU VERITAS

Test Report No.: W7L-P23120015R102

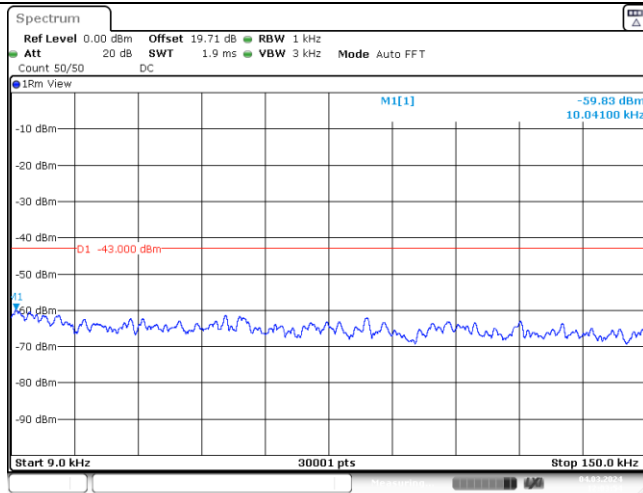

Band2-20MHz-16QAM-19100-1-0-High-0.009-0.15--59.83-PASS

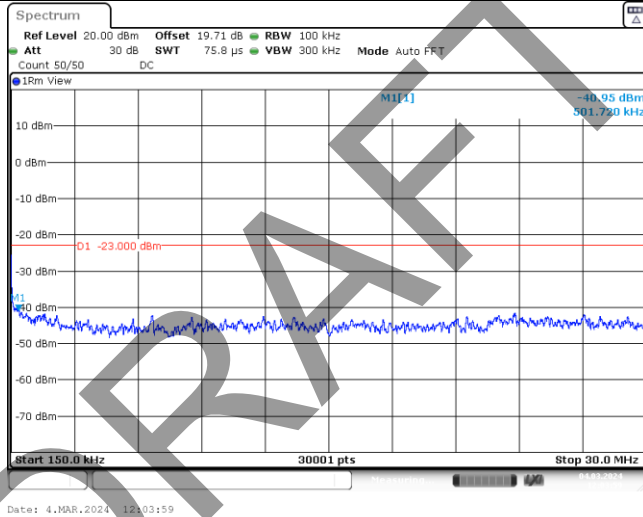

Band2-20MHz-16QAM-19100-1-0-High-0.15-30--40.95-PASS

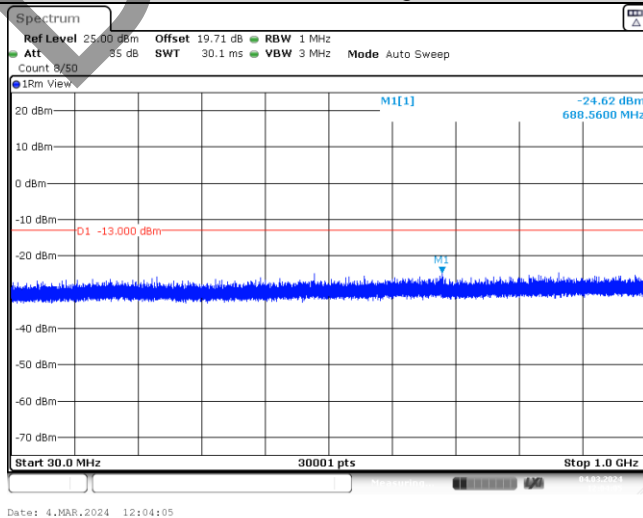

Band2-20MHz-16QAM-19100-1-0-High-30-1000--24.62-PASS

BV 7Layers Communications Technology (Shenzhen) Co., Ltd

Room B37, Warehouse A5, No.3 Chiwan 4th Road, Zhaoshang Street, Nanshan District Shenzhen, Guangdong, People's Republic of China

Tel: +86 755 8869 6566 Fax: +86 755 8869 6577

Email: customerservice.sw@bureauveritas.com



BUREAU VERITAS

Test Report No.: W7L-P23120015R102

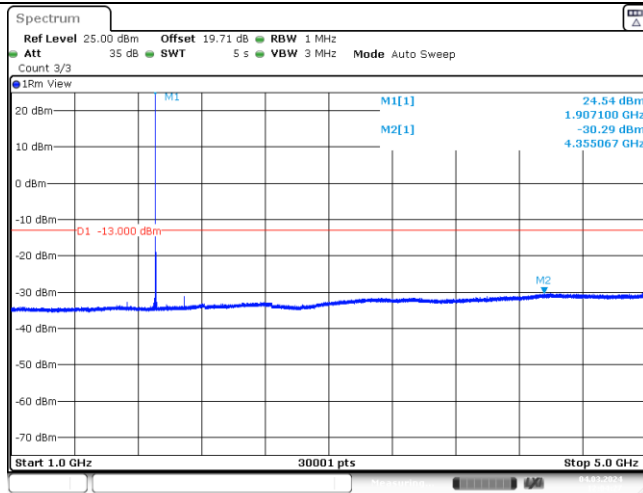

Band2-20MHz-16QAM-19100-1-0-High-1000-5000--30.29-PASS

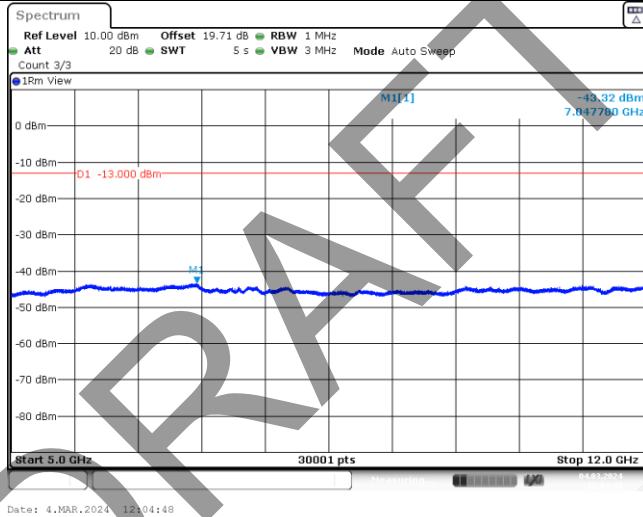

Band2-20MHz-16QAM-19100-1-0-High-5000-12000--43.32-PASS

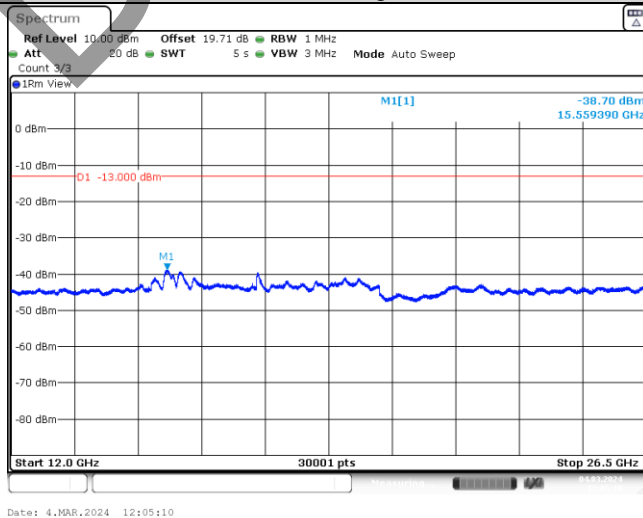

Band2-20MHz-16QAM-19100-1-0-High-12000-26500--38.7-PASS

BV 7Layers Communications Technology (Shenzhen) Co., Ltd

Room B37, Warehouse A5, No.3 Chiwan 4th Road, Zhaoshang Street, Nanshan District Shenzhen, Guangdong, People's Republic of China

Tel: +86 755 8869 6566 Fax: +86 755 8869 6577

Email: customerservice.sw@bureauveritas.com



BAND 25 TEST RESULT

Band	Bandwidth	Modulation	Channel	RB Size	RB Start	NB Index	Start Freq	Stop Freq	Result (dBm)	Verdict
Band25	1.4MHz	26047	QPSK	1	0	Low	0.009	0.15	-61.11	PASS
Band25	1.4MHz	26047	QPSK	1	0	Low	0.15	30	-40.03	PASS
Band25	1.4MHz	26047	QPSK	1	0	Low	30	1000	-23.57	PASS
Band25	1.4MHz	26047	QPSK	1	0	Low	1000	5000	-28.08	PASS
Band25	1.4MHz	26047	QPSK	1	0	Low	5000	12000	-43.16	PASS
Band25	1.4MHz	26047	QPSK	1	0	Low	12000	26500	-38.46	PASS
Band25	1.4MHz	26365	QPSK	1	0	Low	0.009	0.15	-61.65	PASS
Band25	1.4MHz	26365	QPSK	1	0	Low	0.15	30	-39.13	PASS
Band25	1.4MHz	26365	QPSK	1	0	Low	30	1000	-24.36	PASS
Band25	1.4MHz	26365	QPSK	1	0	Low	1000	5000	-27.46	PASS
Band25	1.4MHz	26365	QPSK	1	0	Low	5000	12000	-43.11	PASS
Band25	1.4MHz	26365	QPSK	1	0	Low	12000	26500	-38.53	PASS
Band25	1.4MHz	26683	QPSK	1	0	High	0.009	0.15	-60.75	PASS
Band25	1.4MHz	26683	QPSK	1	0	High	0.15	30	-40.2	PASS
Band25	1.4MHz	26683	QPSK	1	0	High	30	1000	-24.34	PASS
Band25	1.4MHz	26683	QPSK	1	0	High	1000	5000	-29.79	PASS
Band25	1.4MHz	26683	QPSK	1	0	High	5000	12000	-42.8	PASS
Band25	1.4MHz	26683	QPSK	1	0	High	12000	26500	-38.25	PASS
Band25	1.4MHz	26047	16QAM	1	0	Low	0.009	0.15	-59.9	PASS
Band25	1.4MHz	26047	16QAM	1	0	Low	0.15	30	-40.47	PASS
Band25	1.4MHz	26047	16QAM	1	0	Low	30	1000	-23.77	PASS
Band25	1.4MHz	26047	16QAM	1	0	Low	1000	5000	-28.51	PASS
Band25	1.4MHz	26047	16QAM	1	0	Low	5000	12000	-43.29	PASS
Band25	1.4MHz	26047	16QAM	1	0	Low	12000	26500	-38.55	PASS
Band25	1.4MHz	26365	16QAM	1	0	Low	0.009	0.15	-60.43	PASS
Band25	1.4MHz	26365	16QAM	1	0	Low	0.15	30	-40.75	PASS
Band25	1.4MHz	26365	16QAM	1	0	Low	30	1000	-24.83	PASS
Band25	1.4MHz	26365	16QAM	1	0	Low	1000	5000	-27.11	PASS
Band25	1.4MHz	26365	16QAM	1	0	Low	5000	12000	-43.12	PASS
Band25	1.4MHz	26365	16QAM	1	0	Low	12000	26500	-38.21	PASS
Band25	1.4MHz	26683	16QAM	1	0	High	0.009	0.15	-60.42	PASS
Band25	1.4MHz	26683	16QAM	1	0	High	0.15	30	-40.52	PASS
Band25	1.4MHz	26683	16QAM	1	0	High	30	1000	-24.39	PASS
Band25	1.4MHz	26683	16QAM	1	0	High	1000	5000	-27	PASS
Band25	1.4MHz	26683	16QAM	1	0	High	5000	12000	-42.76	PASS
Band25	1.4MHz	26683	16QAM	1	0	High	12000	26500	-38.2	PASS
Band25	3MHz	26055	QPSK	1	0	Low	0.009	0.15	-61.76	PASS
Band25	3MHz	26055	QPSK	1	0	Low	0.15	30	-41.07	PASS
Band25	3MHz	26055	QPSK	1	0	Low	30	1000	-24.89	PASS
Band25	3MHz	26055	QPSK	1	0	Low	1000	5000	-29.66	PASS
Band25	3MHz	26055	QPSK	1	0	Low	5000	12000	-43.38	PASS
Band25	3MHz	26055	QPSK	1	0	Low	12000	26500	-38.53	PASS
Band25	3MHz	26365	QPSK	1	0	Low	0.009	0.15	-61.15	PASS
Band25	3MHz	26365	QPSK	1	0	Low	0.15	30	-40.71	PASS
Band25	3MHz	26365	QPSK	1	0	Low	30	1000	-24.74	PASS
Band25	3MHz	26365	QPSK	1	0	Low	1000	5000	-28.42	PASS
Band25	3MHz	26365	QPSK	1	0	Low	5000	12000	-43.4	PASS
Band25	3MHz	26365	QPSK	1	0	Low	12000	26500	-38.58	PASS



BUREAU
VERITAS

Test Report No.: W7L-P23120015R102

Band25	3MHz	26675	QPSK	1	0	High	0.009	0.15	-59.71	PASS
Band25	3MHz	26675	QPSK	1	0	High	0.15	30	-40.09	PASS
Band25	3MHz	26675	QPSK	1	0	High	30	1000	-24.52	PASS
Band25	3MHz	26675	QPSK	1	0	High	1000	5000	-28	PASS
Band25	3MHz	26675	QPSK	1	0	High	5000	12000	-43.14	PASS
Band25	3MHz	26675	QPSK	1	0	High	12000	26500	-38.43	PASS
Band25	3MHz	26055	16QAM	1	0	Low	0.009	0.15	-60.42	PASS
Band25	3MHz	26055	16QAM	1	0	Low	0.15	30	-40.59	PASS
Band25	3MHz	26055	16QAM	1	0	Low	30	1000	-23.82	PASS
Band25	3MHz	26055	16QAM	1	0	Low	1000	5000	-30.31	PASS
Band25	3MHz	26055	16QAM	1	0	Low	5000	12000	-43.35	PASS
Band25	3MHz	26055	16QAM	1	0	Low	12000	26500	-38.66	PASS
Band25	3MHz	26365	16QAM	1	0	Low	0.009	0.15	-60.68	PASS
Band25	3MHz	26365	16QAM	1	0	Low	0.15	30	-39.92	PASS
Band25	3MHz	26365	16QAM	1	0	Low	30	1000	-24.14	PASS
Band25	3MHz	26365	16QAM	1	0	Low	1000	5000	-29.92	PASS
Band25	3MHz	26365	16QAM	1	0	Low	5000	12000	-43.39	PASS
Band25	3MHz	26365	16QAM	1	0	Low	12000	26500	-38.59	PASS
Band25	3MHz	26675	16QAM	1	0	High	0.009	0.15	-61.05	PASS
Band25	3MHz	26675	16QAM	1	0	High	0.15	30	-40.1	PASS
Band25	3MHz	26675	16QAM	1	0	High	30	1000	-24.04	PASS
Band25	3MHz	26675	16QAM	1	0	High	1000	5000	-30.07	PASS
Band25	3MHz	26675	16QAM	1	0	High	5000	12000	-42.97	PASS
Band25	3MHz	26675	16QAM	1	0	High	12000	26500	-38.33	PASS
Band25	5MHz	26065	QPSK	1	0	Low	0.009	0.15	-60.73	PASS
Band25	5MHz	26065	QPSK	1	0	Low	0.15	30	-40.38	PASS
Band25	5MHz	26065	QPSK	1	0	Low	30	1000	-25.11	PASS
Band25	5MHz	26065	QPSK	1	0	Low	1000	5000	-30.33	PASS
Band25	5MHz	26065	QPSK	1	0	Low	5000	12000	-43.79	PASS
Band25	5MHz	26065	QPSK	1	0	Low	12000	26500	-39.15	PASS
Band25	5MHz	26365	QPSK	1	0	Low	0.009	0.15	-60.94	PASS
Band25	5MHz	26365	QPSK	1	0	Low	0.15	30	-40.25	PASS
Band25	5MHz	26365	QPSK	1	0	Low	30	1000	-25.09	PASS
Band25	5MHz	26365	QPSK	1	0	Low	1000	5000	-29.4	PASS
Band25	5MHz	26365	QPSK	1	0	Low	5000	12000	-43.62	PASS
Band25	5MHz	26365	QPSK	1	0	Low	12000	26500	-39.06	PASS
Band25	5MHz	26665	QPSK	1	0	High	0.009	0.15	-60.26	PASS
Band25	5MHz	26665	QPSK	1	0	High	0.15	30	-39.88	PASS
Band25	5MHz	26665	QPSK	1	0	High	30	1000	-24.57	PASS
Band25	5MHz	26665	QPSK	1	0	High	1000	5000	-29.66	PASS
Band25	5MHz	26665	QPSK	1	0	High	5000	12000	-43.43	PASS
Band25	5MHz	26665	QPSK	1	0	High	12000	26500	-38.58	PASS
Band25	5MHz	26065	16QAM	1	0	Low	0.009	0.15	-60.19	PASS
Band25	5MHz	26065	16QAM	1	0	Low	0.15	30	-40.22	PASS
Band25	5MHz	26065	16QAM	1	0	Low	30	1000	-25.31	PASS
Band25	5MHz	26065	16QAM	1	0	Low	1000	5000	-29.89	PASS
Band25	5MHz	26065	16QAM	1	0	Low	5000	12000	-43.78	PASS
Band25	5MHz	26065	16QAM	1	0	Low	12000	26500	-39.08	PASS
Band25	5MHz	26365	16QAM	1	0	Low	0.009	0.15	-60.58	PASS
Band25	5MHz	26365	16QAM	1	0	Low	0.15	30	-40.19	PASS
Band25	5MHz	26365	16QAM	1	0	Low	30	1000	-25.04	PASS
Band25	5MHz	26365	16QAM	1	0	Low	1000	5000	-29.22	PASS



**BUREAU
VERITAS**

Test Report No.: W7L-P23120015R102

Band25	5MHz	26365	16QAM	1	0	Low	5000	12000	-43.62	PASS
Band25	5MHz	26365	16QAM	1	0	Low	12000	26500	-39.06	PASS
Band25	5MHz	26665	16QAM	1	0	High	0.009	0.15	-61.2	PASS
Band25	5MHz	26665	16QAM	1	0	High	0.15	30	-39.69	PASS
Band25	5MHz	26665	16QAM	1	0	High	30	1000	-24.84	PASS
Band25	5MHz	26665	16QAM	1	0	High	1000	5000	-30.27	PASS
Band25	5MHz	26665	16QAM	1	0	High	5000	12000	-43.11	PASS
Band25	5MHz	26665	16QAM	1	0	High	12000	26500	-38.81	PASS
Band25	10MHz	26090	QPSK	1	0	Low	0.009	0.15	-60.89	PASS
Band25	10MHz	26090	QPSK	1	0	Low	0.15	30	-39.92	PASS
Band25	10MHz	26090	QPSK	1	0	Low	30	1000	-25.04	PASS
Band25	10MHz	26090	QPSK	1	0	Low	1000	5000	-29.66	PASS
Band25	10MHz	26090	QPSK	1	0	Low	5000	12000	-43.8	PASS
Band25	10MHz	26090	QPSK	1	0	Low	12000	26500	-39.13	PASS
Band25	10MHz	26365	QPSK	1	0	Low	0.009	0.15	-61.45	PASS
Band25	10MHz	26365	QPSK	1	0	Low	0.15	30	-40.15	PASS
Band25	10MHz	26365	QPSK	1	0	Low	30	1000	-24.67	PASS
Band25	10MHz	26365	QPSK	1	0	Low	1000	5000	-30.5	PASS
Band25	10MHz	26365	QPSK	1	0	Low	5000	12000	-43.59	PASS
Band25	10MHz	26365	QPSK	1	0	Low	12000	26500	-39.04	PASS
Band25	10MHz	26640	QPSK	1	0	High	0.009	0.15	-60.35	PASS
Band25	10MHz	26640	QPSK	1	0	High	0.15	30	-39.77	PASS
Band25	10MHz	26640	QPSK	1	0	High	30	1000	-24.72	PASS
Band25	10MHz	26640	QPSK	1	0	High	1000	5000	-29.88	PASS
Band25	10MHz	26640	QPSK	1	0	High	5000	12000	-43.34	PASS
Band25	10MHz	26640	QPSK	1	0	High	12000	26500	-38.78	PASS
Band25	10MHz	26090	16QAM	1	0	Low	0.009	0.15	-59.43	PASS
Band25	10MHz	26090	16QAM	1	0	Low	0.15	30	-40.86	PASS
Band25	10MHz	26090	16QAM	1	0	Low	30	1000	-25.19	PASS
Band25	10MHz	26090	16QAM	1	0	Low	1000	5000	-30.43	PASS
Band25	10MHz	26090	16QAM	1	0	Low	5000	12000	-43.72	PASS
Band25	10MHz	26090	16QAM	1	0	Low	12000	26500	-39.06	PASS
Band25	10MHz	26365	16QAM	1	0	Low	0.009	0.15	-60.47	PASS
Band25	10MHz	26365	16QAM	1	0	Low	0.15	30	-40.26	PASS
Band25	10MHz	26365	16QAM	1	0	Low	30	1000	-24.78	PASS
Band25	10MHz	26365	16QAM	1	0	Low	1000	5000	-29.54	PASS
Band25	10MHz	26365	16QAM	1	0	Low	5000	12000	-43.8	PASS
Band25	10MHz	26365	16QAM	1	0	Low	12000	26500	-39.05	PASS
Band25	10MHz	26640	16QAM	1	0	High	0.009	0.15	-60.09	PASS
Band25	10MHz	26640	16QAM	1	0	High	0.15	30	-39.4	PASS
Band25	10MHz	26640	16QAM	1	0	High	30	1000	-24.74	PASS
Band25	10MHz	26640	16QAM	1	0	High	1000	5000	-29.09	PASS
Band25	10MHz	26640	16QAM	1	0	High	5000	12000	-43.47	PASS
Band25	10MHz	26640	16QAM	1	0	High	12000	26500	-38.97	PASS
Band25	15MHz	26115	QPSK	1	0	Low	0.009	0.15	-61.6	PASS
Band25	15MHz	26115	QPSK	1	0	Low	0.15	30	-40.61	PASS
Band25	15MHz	26115	QPSK	1	0	Low	30	1000	-24.84	PASS
Band25	15MHz	26115	QPSK	1	0	Low	1000	5000	-30.53	PASS
Band25	15MHz	26115	QPSK	1	0	Low	5000	12000	-43.76	PASS
Band25	15MHz	26115	QPSK	1	0	Low	12000	26500	-38.95	PASS
Band25	15MHz	26365	QPSK	1	0	Low	0.009	0.15	-60.7	PASS
Band25	15MHz	26365	QPSK	1	0	Low	0.15	30	-40.57	PASS

BV 7Layers Communications Technology
(Shenzhen) Co., Ltd

Room B37, Warehouse A5, No.3 Chiwan 4th Road,
Zhaoshang Street, Nanshan District Shenzhen,
Guangdong, People's Republic of China

Tel: +86 755 8869 6566
Fax: +86 755 8869 6577
Email: customerservice.sw@bureauveritas.com



BUREAU VERITAS

Test Report No.: W7L-P23120015R102

Band25	15MHz	26365	QPSK	1	0	Low	30	1000	-24.37	PASS
Band25	15MHz	26365	QPSK	1	0	Low	1000	5000	-30.47	PASS
Band25	15MHz	26365	QPSK	1	0	Low	5000	12000	-43.57	PASS
Band25	15MHz	26365	QPSK	1	0	Low	12000	26500	-38.85	PASS
Band25	15MHz	26615	QPSK	1	0	High	0.009	0.15	-61.67	PASS
Band25	15MHz	26615	QPSK	1	0	High	0.15	30	-40.69	PASS
Band25	15MHz	26615	QPSK	1	0	High	30	1000	-25.39	PASS
Band25	15MHz	26615	QPSK	1	0	High	1000	5000	-29.39	PASS
Band25	15MHz	26615	QPSK	1	0	High	5000	12000	-43.62	PASS
Band25	15MHz	26615	QPSK	1	0	High	12000	26500	-39.05	PASS
Band25	15MHz	26115	16QAM	1	0	Low	0.009	0.15	-60.74	PASS
Band25	15MHz	26115	16QAM	1	0	Low	0.15	30	-39.9	PASS
Band25	15MHz	26115	16QAM	1	0	Low	30	1000	-24.84	PASS
Band25	15MHz	26115	16QAM	1	0	Low	1000	5000	-30.66	PASS
Band25	15MHz	26115	16QAM	1	0	Low	5000	12000	-43.72	PASS
Band25	15MHz	26115	16QAM	1	0	Low	12000	26500	-39.12	PASS
Band25	15MHz	26365	16QAM	1	0	Low	0.009	0.15	-61.6	PASS
Band25	15MHz	26365	16QAM	1	0	Low	0.15	30	-40.44	PASS
Band25	15MHz	26365	16QAM	1	0	Low	30	1000	-24.73	PASS
Band25	15MHz	26365	16QAM	1	0	Low	1000	5000	-29.27	PASS
Band25	15MHz	26365	16QAM	1	0	Low	5000	12000	-43.58	PASS
Band25	15MHz	26365	16QAM	1	0	Low	12000	26500	-39.03	PASS
Band25	15MHz	26615	16QAM	1	0	High	0.009	0.15	-60.69	PASS
Band25	15MHz	26615	16QAM	1	0	High	0.15	30	-40.96	PASS
Band25	15MHz	26615	16QAM	1	0	High	30	1000	-24.64	PASS
Band25	15MHz	26615	16QAM	1	0	High	1000	5000	-30.49	PASS
Band25	15MHz	26615	16QAM	1	0	High	5000	12000	-43.74	PASS
Band25	15MHz	26615	16QAM	1	0	High	12000	26500	-39.05	PASS
Band25	20MHz	26140	QPSK	1	0	Low	0.009	0.15	-60.68	PASS
Band25	20MHz	26140	QPSK	1	0	Low	0.15	30	-40.39	PASS
Band25	20MHz	26140	QPSK	1	0	Low	30	1000	-24.42	PASS
Band25	20MHz	26140	QPSK	1	0	Low	1000	5000	-29.83	PASS
Band25	20MHz	26140	QPSK	1	0	Low	5000	12000	-43.79	PASS
Band25	20MHz	26140	QPSK	1	0	Low	12000	26500	-39.14	PASS
Band25	20MHz	26365	QPSK	1	0	Low	0.009	0.15	-62.08	PASS
Band25	20MHz	26365	QPSK	1	0	Low	0.15	30	-40.45	PASS
Band25	20MHz	26365	QPSK	1	0	Low	30	1000	-24.25	PASS
Band25	20MHz	26365	QPSK	1	0	Low	1000	5000	-29.41	PASS
Band25	20MHz	26365	QPSK	1	0	Low	5000	12000	-43.49	PASS
Band25	20MHz	26365	QPSK	1	0	Low	12000	26500	-39.18	PASS
Band25	20MHz	26590	QPSK	1	0	High	0.009	0.15	-60.93	PASS
Band25	20MHz	26590	QPSK	1	0	High	0.15	30	-39.78	PASS
Band25	20MHz	26590	QPSK	1	0	High	30	1000	-24.08	PASS
Band25	20MHz	26590	QPSK	1	0	High	1000	5000	-29.53	PASS
Band25	20MHz	26590	QPSK	1	0	High	5000	12000	-43.7	PASS
Band25	20MHz	26590	QPSK	1	0	High	12000	26500	-39.05	PASS
Band25	20MHz	26140	16QAM	1	0	Low	0.009	0.15	-61.36	PASS
Band25	20MHz	26140	16QAM	1	0	Low	0.15	30	-39.74	PASS
Band25	20MHz	26140	16QAM	1	0	Low	30	1000	-24.49	PASS
Band25	20MHz	26140	16QAM	1	0	Low	1000	5000	-30.2	PASS
Band25	20MHz	26140	16QAM	1	0	Low	5000	12000	-43.71	PASS
Band25	20MHz	26140	16QAM	1	0	Low	12000	26500	-39.3	PASS

BV 7Layers Communications Technology (Shenzhen) Co., Ltd

Room B37, Warehouse A5, No.3 Chiwan 4th Road, Zhaoshang Street, Nanshan District Shenzhen, Guangdong, People's Republic of China

Tel: +86 755 8869 6566 Fax: +86 755 8869 6577 Email: customerservice.sw@bureauveritas.com



**BUREAU
VERITAS**

Test Report No.: W7L-P23120015R102

Band25	20MHz	26365	16QAM	1	0	Low	0.009	0.15	-60.76	PASS
Band25	20MHz	26365	16QAM	1	0	Low	0.15	30	-39.81	PASS
Band25	20MHz	26365	16QAM	1	0	Low	30	1000	-24.6	PASS
Band25	20MHz	26365	16QAM	1	0	Low	1000	5000	-29.82	PASS
Band25	20MHz	26365	16QAM	1	0	Low	5000	12000	-43.41	PASS
Band25	20MHz	26365	16QAM	1	0	Low	12000	26500	-38.98	PASS
Band25	20MHz	26590	16QAM	1	0	High	0.009	0.15	-61.44	PASS
Band25	20MHz	26590	16QAM	1	0	High	0.15	30	-40.67	PASS
Band25	20MHz	26590	16QAM	1	0	High	30	1000	-24.46	PASS
Band25	20MHz	26590	16QAM	1	0	High	1000	5000	-29.38	PASS
Band25	20MHz	26590	16QAM	1	0	High	5000	12000	-43.69	PASS
Band25	20MHz	26590	16QAM	1	0	High	12000	26500	-39.14	PASS

BAND 25 TEST GRAPHS

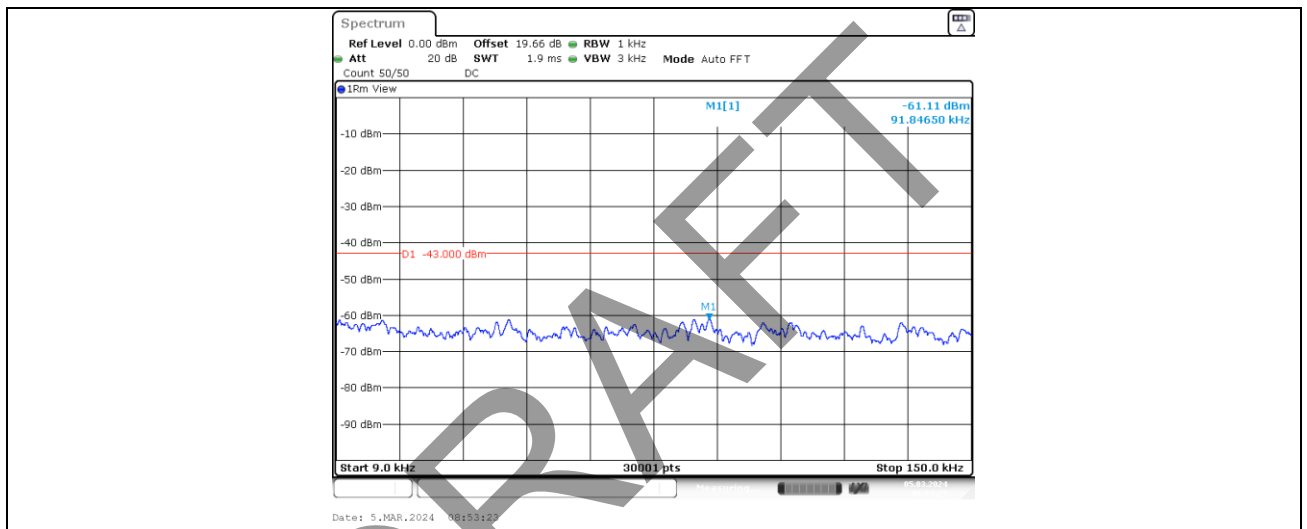

Band25-1.4MHz-QPSK-26047-1-0-Low-0.009-0.15--61.11-PASS

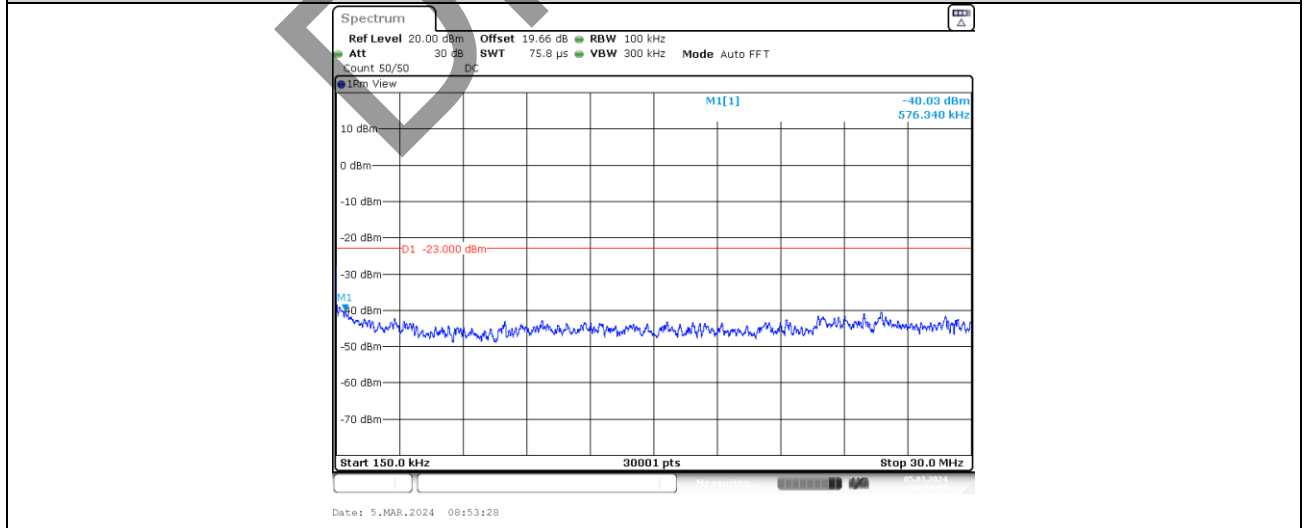

Band25-1.4MHz-QPSK-26047-1-0-Low-0.15-30--40.03-PASS

BV 7Layers Communications Technology
(Shenzhen) Co., Ltd

Room B37, Warehouse A5, No.3 Chiwan 4th Road,
Zhaoshang Street, Nanshan District Shenzhen,
Guangdong, People's Republic of China

Tel: +86 755 8869 6566
 Fax: +86 755 8869 6577
 Email: customerservice.sw@bureauveritas.com



BUREAU VERITAS

Test Report No.: W7L-P23120015R102

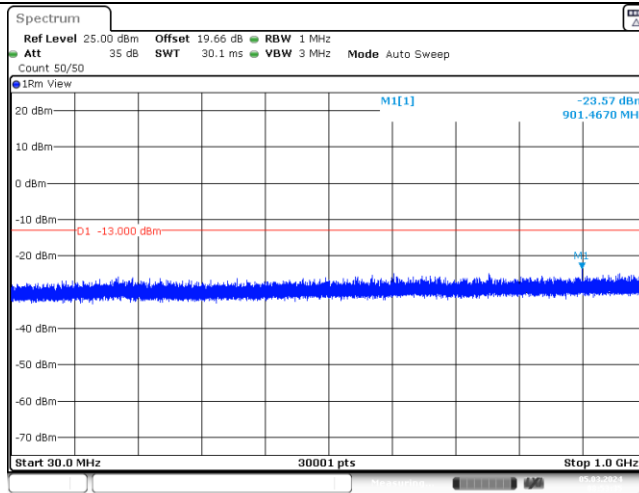

Date: 5.MAR.2024 08:53:35

Band25-1.4MHz-QPSK-26047-1-0-Low-30-1000--23.57-PASS

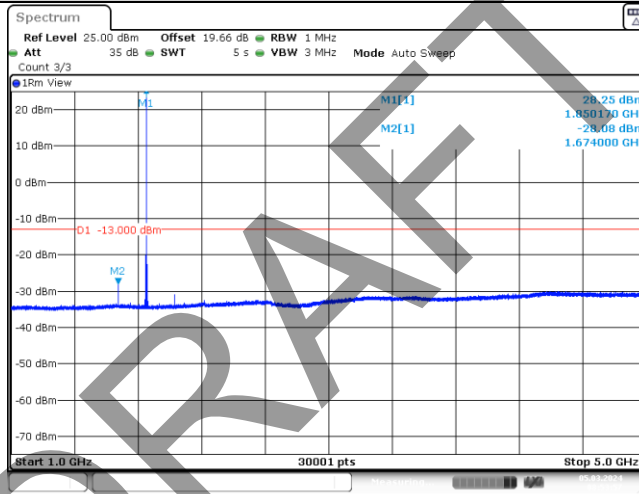

Date: 5.MAR.2024 08:53:57

Band25-1.4MHz-QPSK-26047-1-0-Low-1000-5000--28.08-PASS

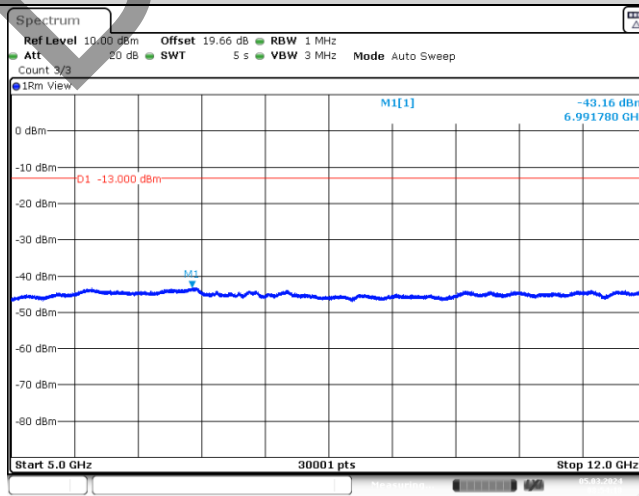

Date: 5.MAR.2024 08:54:18

Band25-1.4MHz-QPSK-26047-1-0-Low-5000-12000--43.16-PASS

BV 7Layers Communications Technology (Shenzhen) Co., Ltd

Room B37, Warehouse A5, No.3 Chiwan 4th Road, Zhaoshang Street, Nanshan District Shenzhen, Guangdong, People's Republic of China

Tel: +86 755 8869 6566 Fax: +86 755 8869 6577

Email: customerservice.sw@bureauveritas.com



BUREAU VERITAS

Test Report No.: W7L-P23120015R102

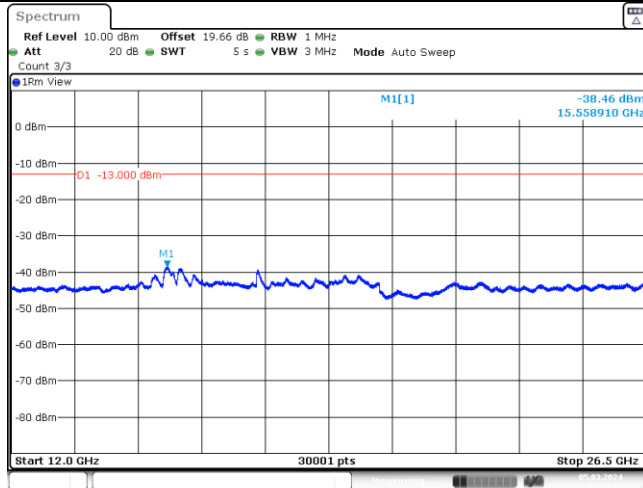

Date: 5.MAR.2024 08:54:39

Band25-1.4MHz-QPSK-26047-1-0-Low-12000-26500--38.46-PASS

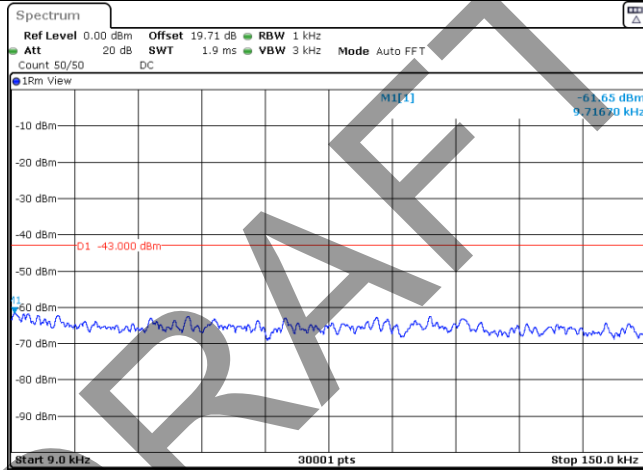

Date: 5.MAR.2024 08:56:07

Band25-1.4MHz-QPSK-26365-1-0-Low-0.009-0.15--61.65-PASS

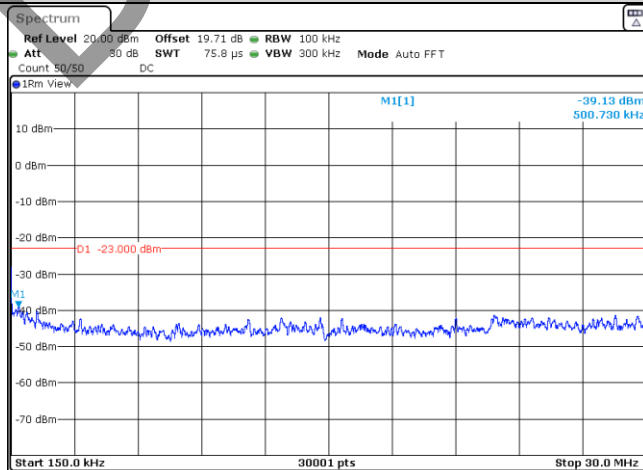

Date: 5.MAR.2024 08:56:12

Band25-1.4MHz-QPSK-26365-1-0-Low-0.15-30--39.13-PASS

BV 7Layers Communications Technology (Shenzhen) Co., Ltd

Room B37, Warehouse A5, No.3 Chiwan 4th Road, Zhaoshang Street, Nanshan District Shenzhen, Guangdong, People's Republic of China

Tel: +86 755 8869 6566 Fax: +86 755 8869 6577

Email: customerservice.sw@bureauveritas.com



BUREAU VERITAS

Test Report No.: W7L-P23120015R102

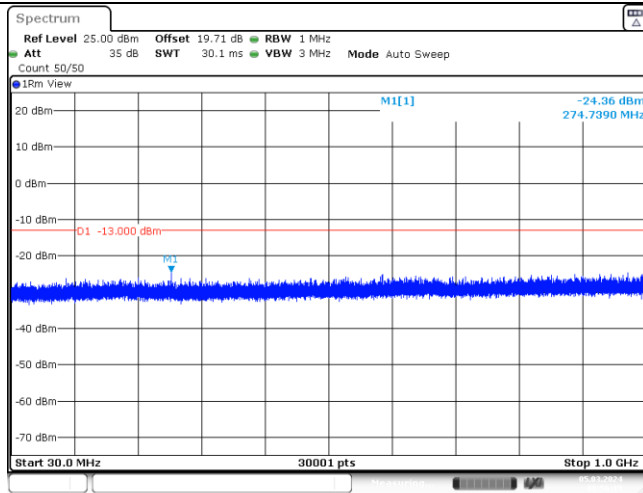

Date: 5.MAR.2024 08:56:18

Band25-1.4MHz-QPSK-26365-1-0-Low-30-1000--24.36-PASS

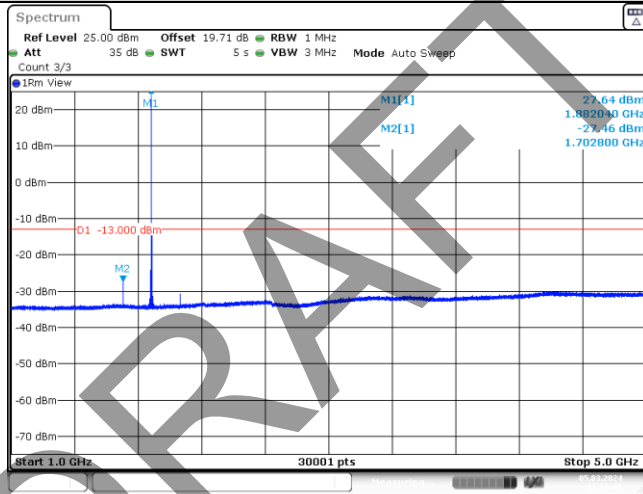

Date: 5.MAR.2024 08:56:41

Band25-1.4MHz-QPSK-26365-1-0-Low-1000-5000--27.46-PASS

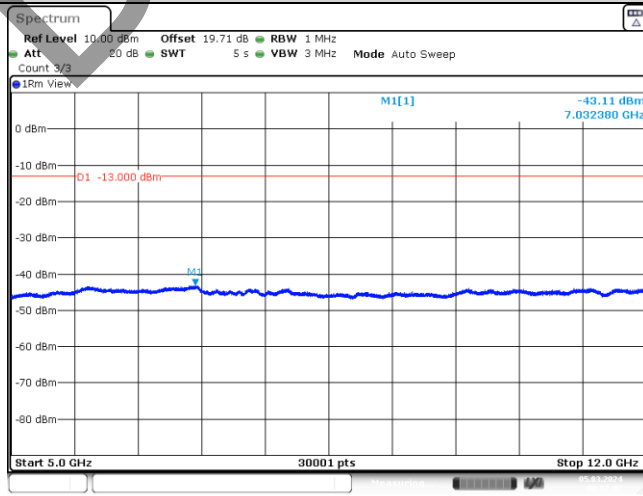

Date: 5.MAR.2024 08:57:02

Band25-1.4MHz-QPSK-26365-1-0-Low-5000-12000--43.11-PASS

BV 7Layers Communications Technology (Shenzhen) Co., Ltd

Room B37, Warehouse A5, No.3 Chiwan 4th Road, Zhaoshang Street, Nanshan District Shenzhen, Guangdong, People's Republic of China

Tel: +86 755 8869 6566 Fax: +86 755 8869 6577 Email: customerservice.sw@bureauveritas.com



BUREAU VERITAS

Test Report No.: W7L-P23120015R102

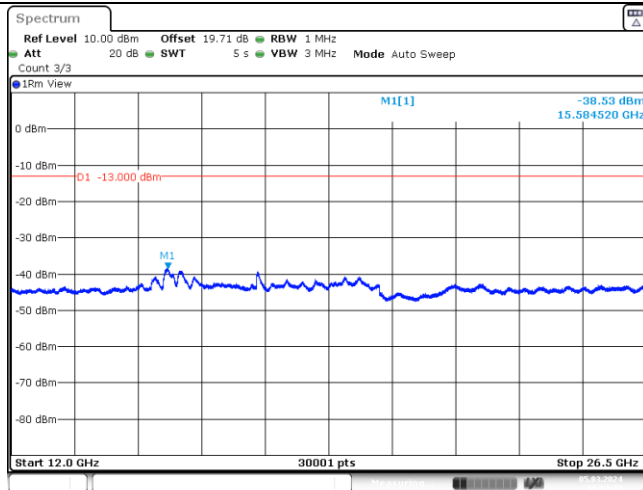

Date: 5.MAR.2024 08:57:23

Band25-1.4MHz-QPSK-26365-1-0-Low-12000-26500--38.53-PASS

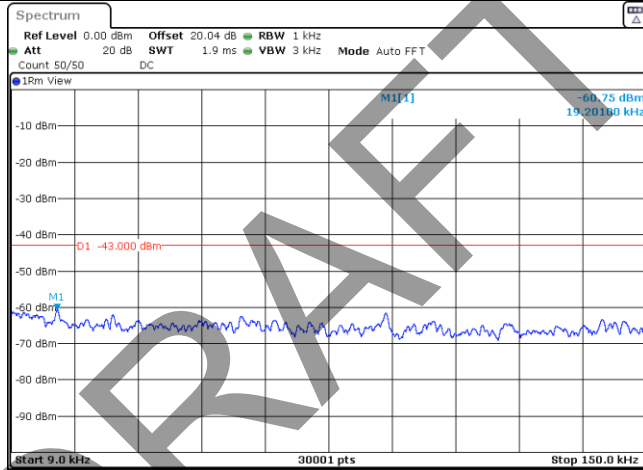

Date: 5.MAR.2024 08:58:56

Band25-1.4MHz-QPSK-26683-1-0-High-0.009-0.15--60.75-PASS

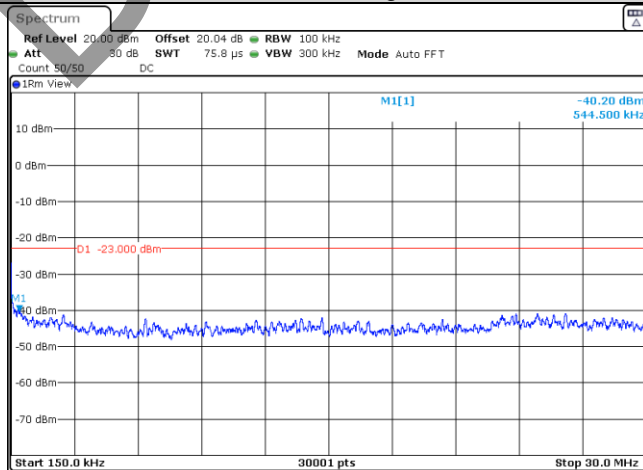

Date: 5.MAR.2024 08:59:01

Band25-1.4MHz-QPSK-26683-1-0-High-0.15-30--40.2-PASS

BV 7Layers Communications Technology (Shenzhen) Co., Ltd

Room B37, Warehouse A5, No.3 Chiwan 4th Road, Zhaoshang Street, Nanshan District Shenzhen, Guangdong, People's Republic of China

Tel: +86 755 8869 6566

Fax: +86 755 8869 6577

Email: customerservice.sw@bureauveritas.com



BUREAU VERITAS

Test Report No.: W7L-P23120015R102

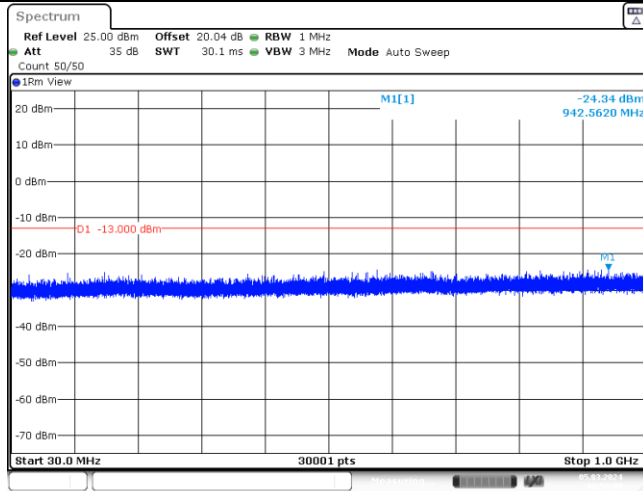

Band25-1.4MHz-QPSK-26683-1-0-High-30-1000--24.34-PASS

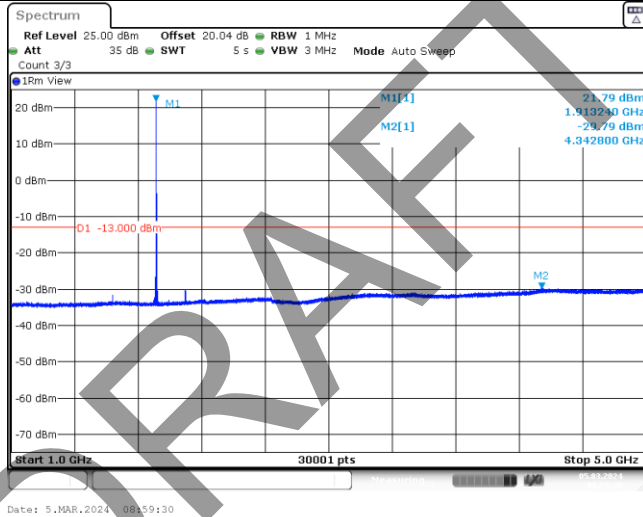

Band25-1.4MHz-QPSK-26683-1-0-High-1000-5000--29.79-PASS

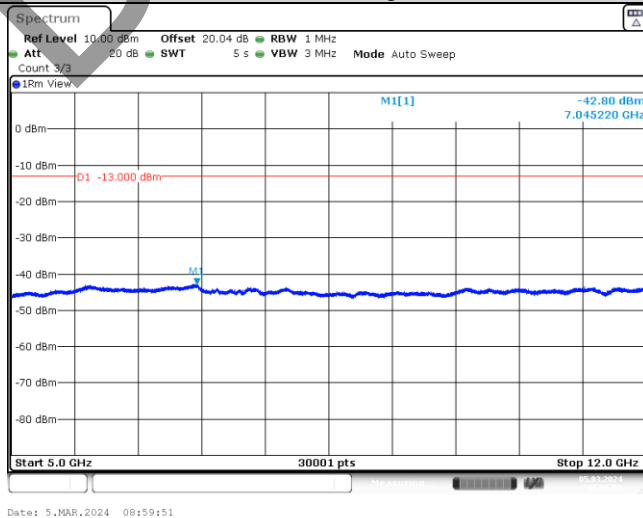

Band25-1.4MHz-QPSK-26683-1-0-High-5000-12000--42.8-PASS

BV 7Layers Communications Technology (Shenzhen) Co., Ltd

Room B37, Warehouse A5, No.3 Chiwan 4th Road, Zhaoshang Street, Nanshan District Shenzhen, Guangdong, People's Republic of China

Tel: +86 755 8869 6566 Fax: +86 755 8869 6577 Email: customerservice.sw@bureauveritas.com



BUREAU VERITAS

Test Report No.: W7L-P23120015R102

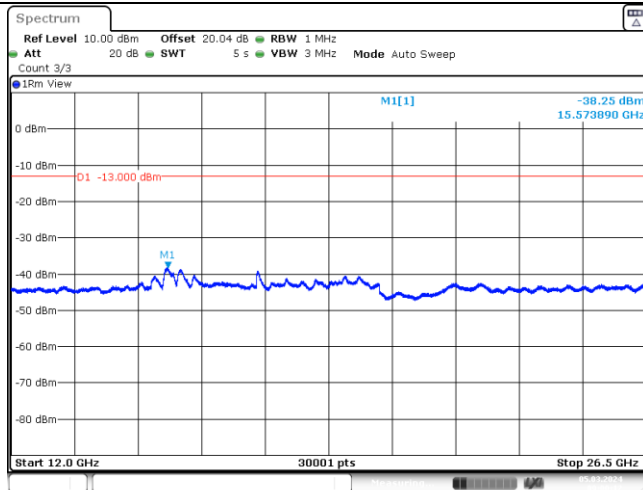

Date: 5.MAR.2024 09:00:12

Band25-1.4MHz-QPSK-26683-1-0-High-12000-26500--38.25-PASS

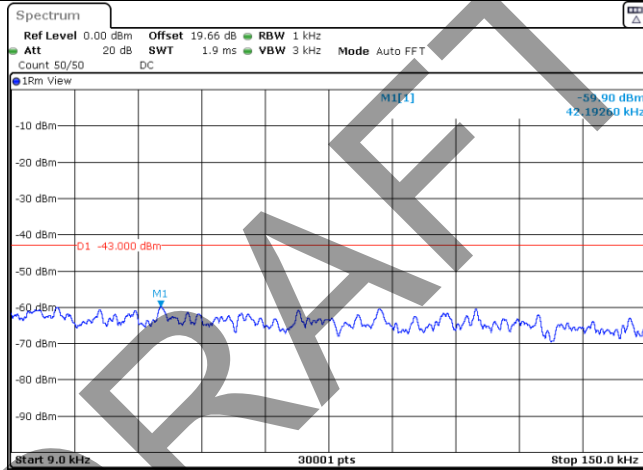

Date: 5.MAR.2024 08:54:44

Band25-1.4MHz-16QAM-26047-1-0-Low-0.009-0.15--59.9-PASS

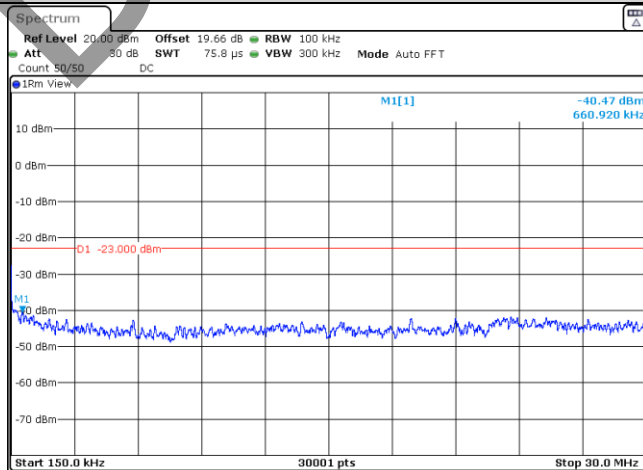

Date: 5.MAR.2024 08:54:49

Band25-1.4MHz-16QAM-26047-1-0-Low-0.15-30--40.47-PASS

BV 7Layers Communications Technology (Shenzhen) Co., Ltd

Room B37, Warehouse A5, No.3 Chiwan 4th Road, Zhaoshang Street, Nanshan District Shenzhen, Guangdong, People's Republic of China

Tel: +86 755 8869 6566 Fax: +86 755 8869 6577 Email: customerservice.sw@bureauveritas.com



BUREAU VERITAS

Test Report No.: W7L-P23120015R102

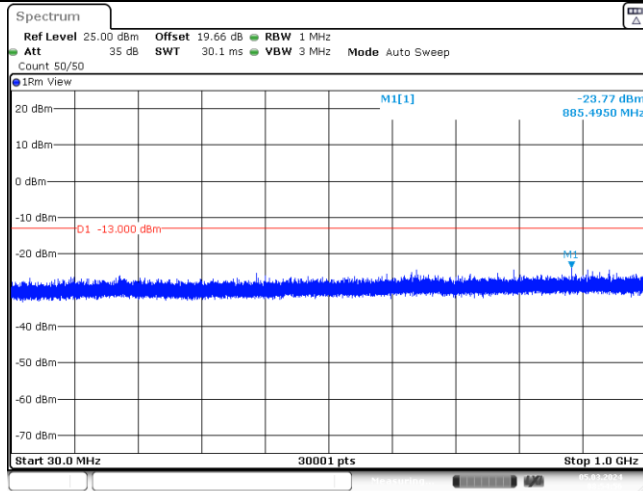

Band25-1.4MHz-16QAM-26047-1-0-Low-30-1000--23.77-PASS

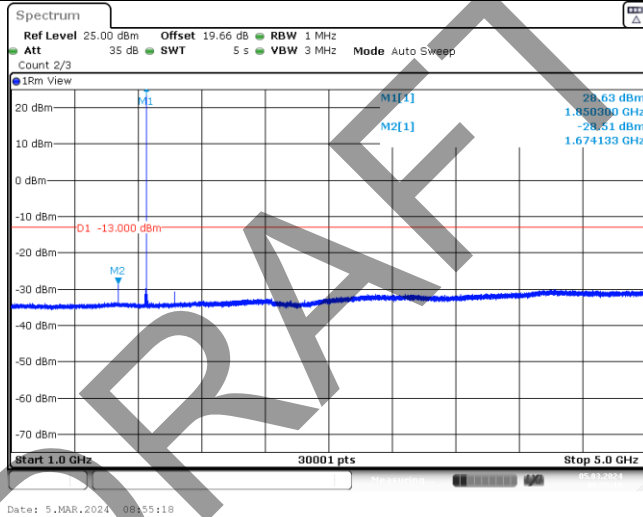

Band25-1.4MHz-16QAM-26047-1-0-Low-1000-5000--28.51-PASS

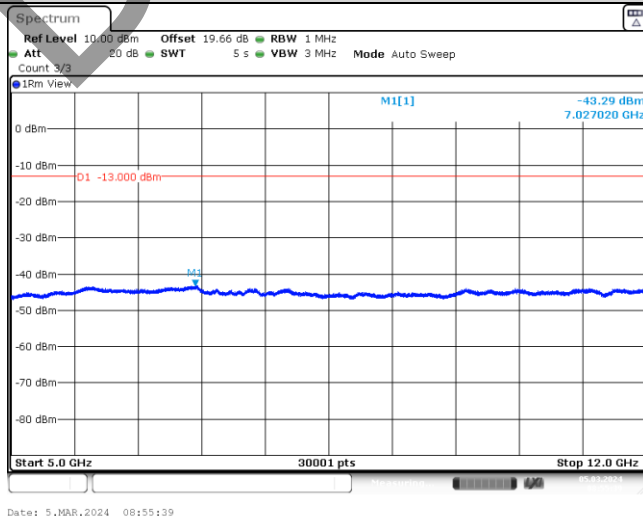

Band25-1.4MHz-16QAM-26047-1-0-Low-5000-12000--43.29-PASS

BV 7Layers Communications Technology (Shenzhen) Co., Ltd

Room B37, Warehouse A5, No.3 Chiwan 4th Road, Zhaoshang Street, Nanshan District Shenzhen, Guangdong, People's Republic of China

Tel: +86 755 8869 6566
Fax: +86 755 8869 6577
Email: customerservice.sw@bureauveritas.com



BUREAU VERITAS

Test Report No.: W7L-P23120015R102

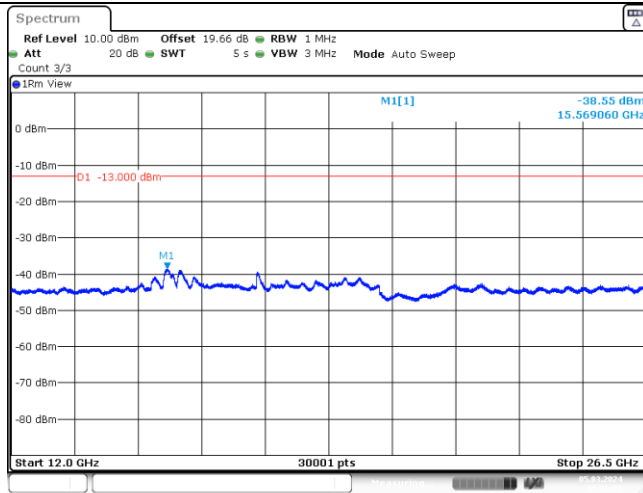

Date: 5.MAR.2024 08:56:00

Band25-1.4MHz-16QAM-26047-1-0-Low-12000-26500--38.55-PASS

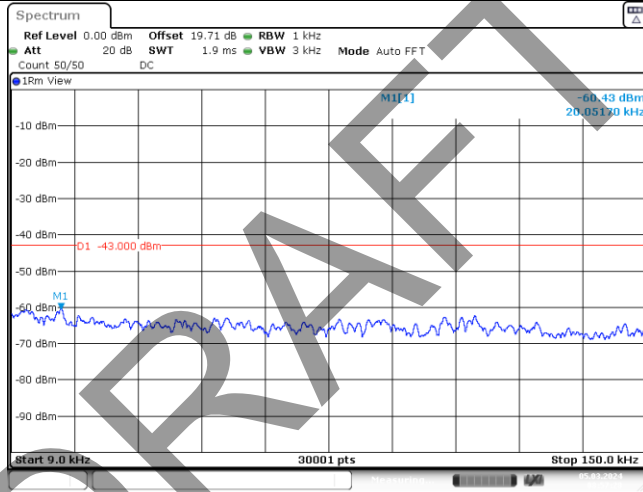

Date: 5.MAR.2024 08:57:28

Band25-1.4MHz-16QAM-26365-1-0-Low-0.009-0.15--60.43-PASS

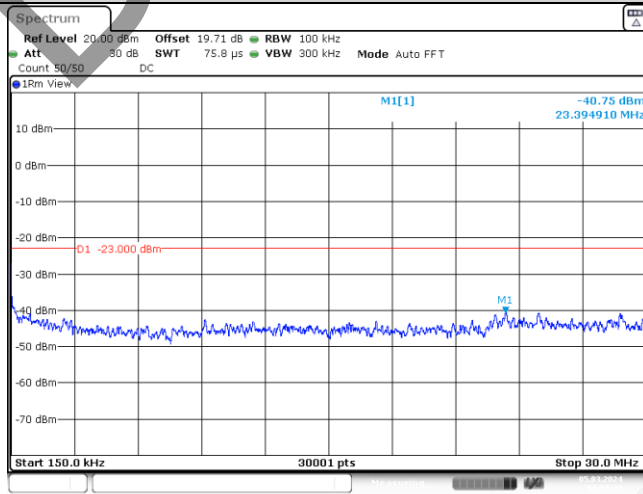

Date: 5.MAR.2024 08:57:33

Band25-1.4MHz-16QAM-26365-1-0-Low-0.15-30--40.75-PASS

BV 7Layers Communications Technology (Shenzhen) Co., Ltd

Room B37, Warehouse A5, No.3 Chiwan 4th Road, Zhaoshang Street, Nanshan District Shenzhen, Guangdong, People's Republic of China

Tel: +86 755 8869 6566 Fax: +86 755 8869 6577

Email: customerservice.sw@bureauveritas.com



BUREAU VERITAS

Test Report No.: W7L-P23120015R102

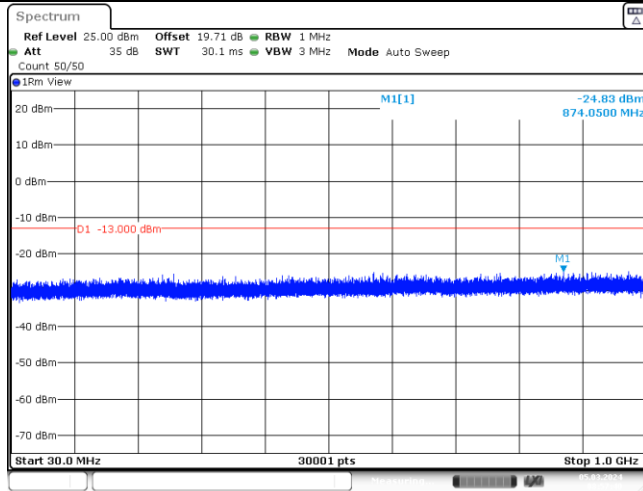

Date: 5.MAR.2024 08:57:40

Band25-1.4MHz-16QAM-26365-1-0-Low-30-1000--24.83-PASS

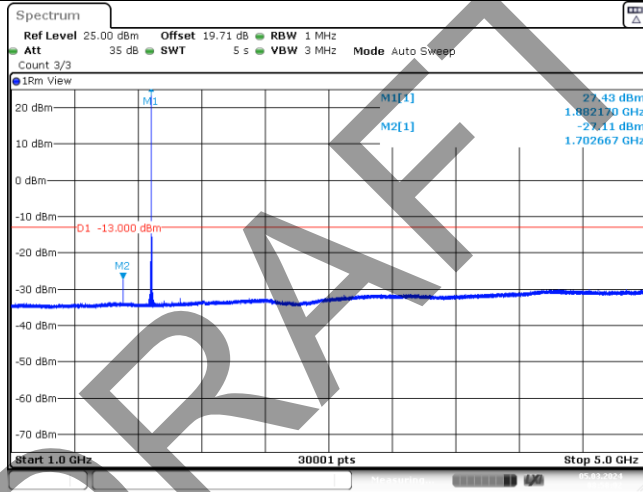

Date: 5.MAR.2024 08:58:02

Band25-1.4MHz-16QAM-26365-1-0-Low-1000-5000--27.11-PASS

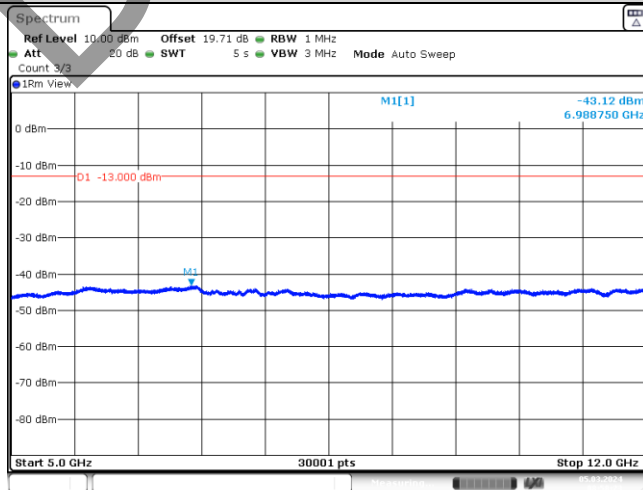

Date: 5.MAR.2024 08:58:23

Band25-1.4MHz-16QAM-26365-1-0-Low-5000-12000--43.12-PASS

BV 7Layers Communications Technology (Shenzhen) Co., Ltd

Room B37, Warehouse A5, No.3 Chiwan 4th Road, Zhaoshang Street, Nanshan District Shenzhen, Guangdong, People's Republic of China

Tel: +86 755 8869 6566 Fax: +86 755 8869 6577

Email: customerservice.sw@bureauveritas.com



BUREAU VERITAS

Test Report No.: W7L-P23120015R102

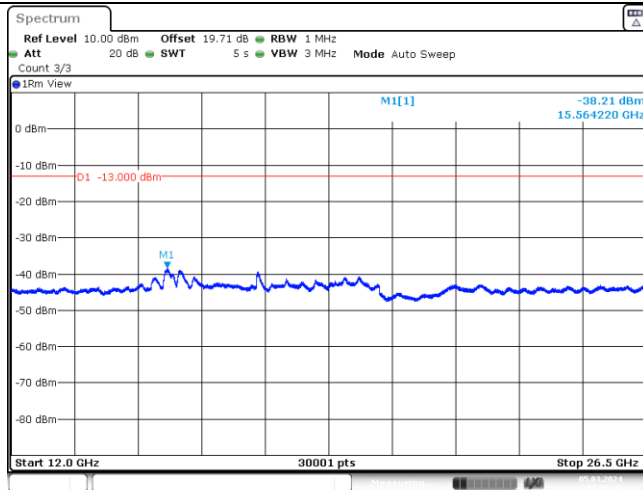

Date: 5.MAR.2024 08:58:44

Band25-1.4MHz-16QAM-26365-1-0-Low-12000-26500--38.21-PASS

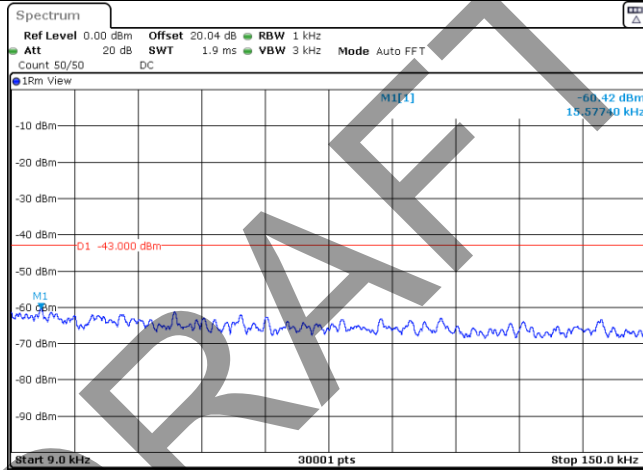

Date: 5.MAR.2024 09:00:17

Band25-1.4MHz-16QAM-26683-1-0-High-0.009-0.15--60.42-PASS

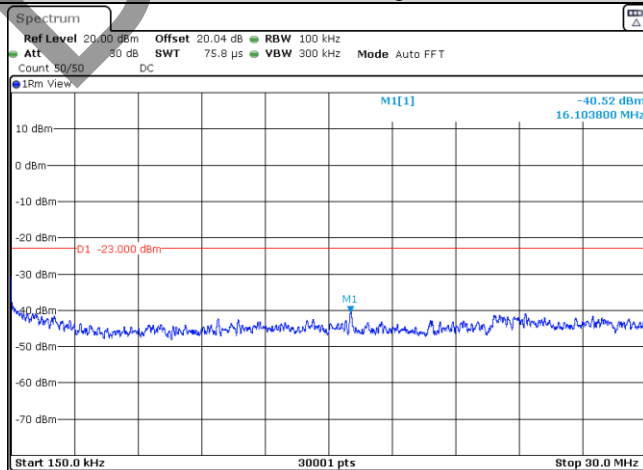

Date: 5.MAR.2024 09:00:22

Band25-1.4MHz-16QAM-26683-1-0-High-0.15-30--40.52-PASS

BV 7Layers Communications Technology (Shenzhen) Co., Ltd

Room B37, Warehouse A5, No.3 Chiwan 4th Road, Zhaoshang Street, Nanshan District Shenzhen, Guangdong, People's Republic of China

Tel: +86 755 8869 6566 Fax: +86 755 8869 6577

Email: customerservice.sw@bureauveritas.com



BUREAU VERITAS

Test Report No.: W7L-P23120015R102

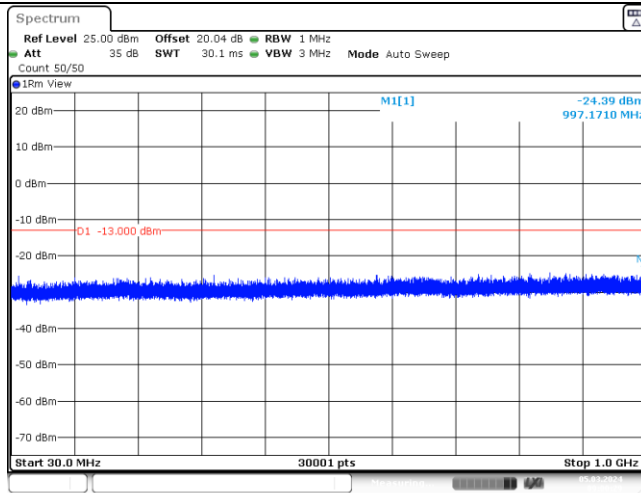

Band25-1.4MHz-16QAM-26683-1-0-High-30-1000--24.39-PASS

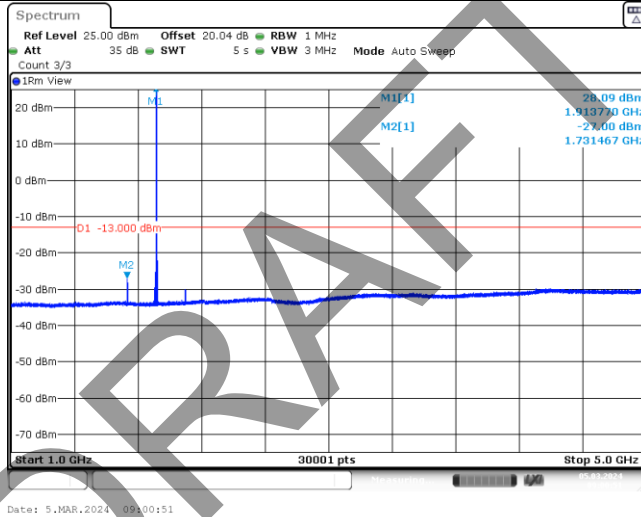

Band25-1.4MHz-16QAM-26683-1-0-High-1000-5000--27-PASS

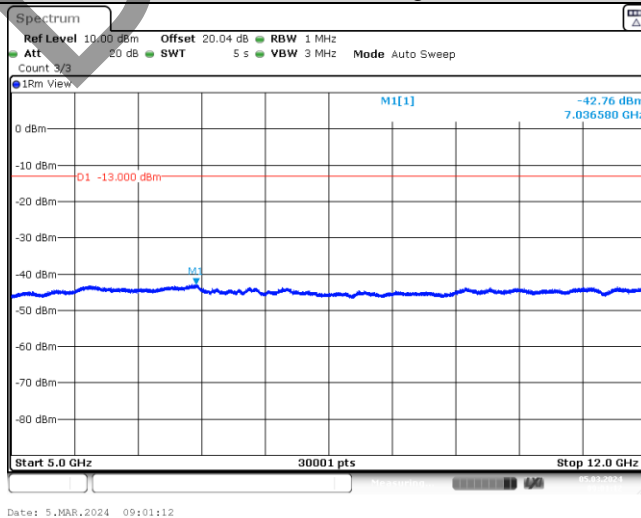

Band25-1.4MHz-16QAM-26683-1-0-High-5000-12000--42.76-PASS

BV 7Layers Communications Technology (Shenzhen) Co., Ltd

Room B37, Warehouse A5, No.3 Chiwan 4th Road, Zhaoshang Street, Nanshan District Shenzhen, Guangdong, People's Republic of China

Tel: +86 755 8869 6566
 Fax: +86 755 8869 6577
 Email: customerservice.sw@bureauveritas.com



BUREAU VERITAS

Test Report No.: W7L-P23120015R102

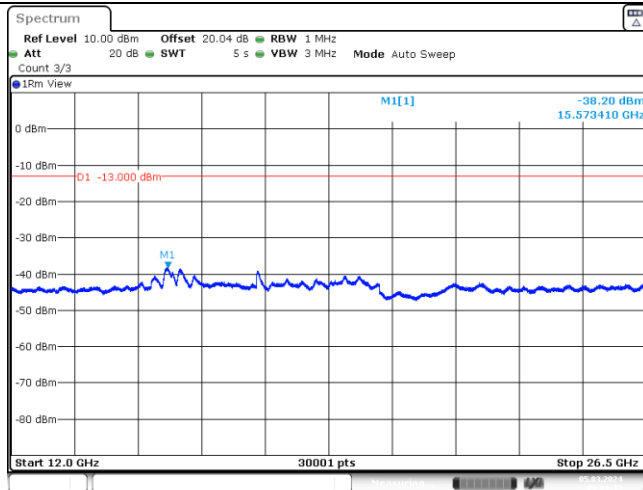

Date: 5.MAR.2024 09:01:33

Band25-1.4MHz-16QAM-26683-1-0-High-12000-26500--38.2-PASS

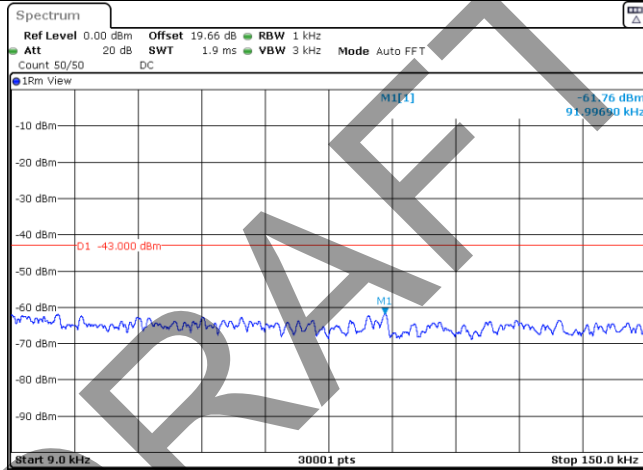

Date: 5.MAR.2024 09:17:55

Band25-3MHz-QPSK-26055-1-0-Low-0.009-0.15--61.76-PASS

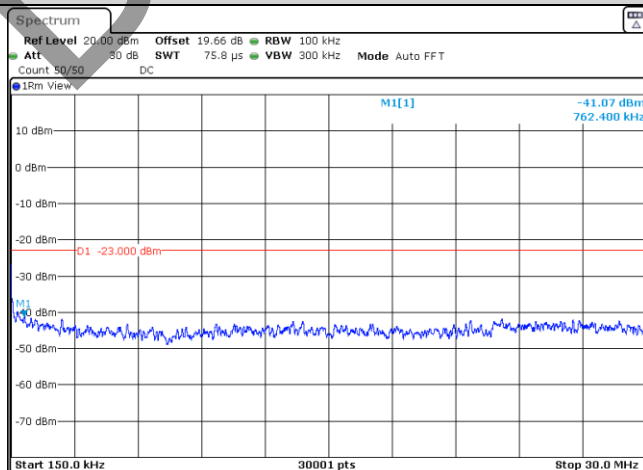

Date: 5.MAR.2024 09:17:59

Band25-3MHz-QPSK-26055-1-0-Low-0.15-30--41.07-PASS

BV 7Layers Communications Technology (Shenzhen) Co., Ltd

Room B37, Warehouse A5, No.3 Chiwan 4th Road, Zhaoshang Street, Nanshan District Shenzhen, Guangdong, People's Republic of China

Tel: +86 755 8869 6566 Fax: +86 755 8869 6577

Email: customerservice.sw@bureauveritas.com



BUREAU VERITAS

Test Report No.: W7L-P23120015R102

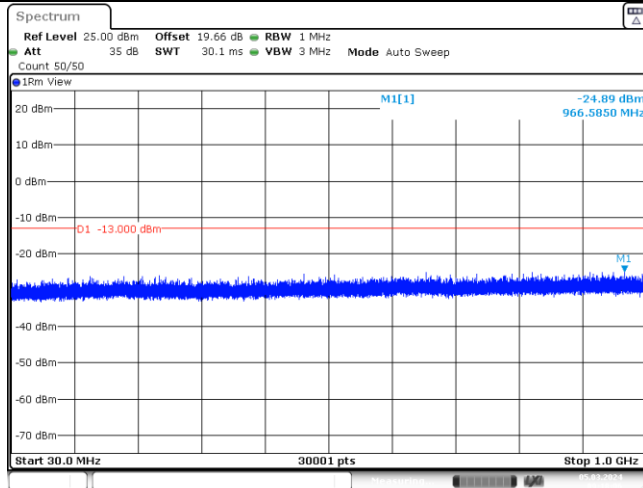

Date: 5.MAR.2024 09:18:06

Band25-3MHz-QPSK-26055-1-0-Low-30-1000--24.89-PASS

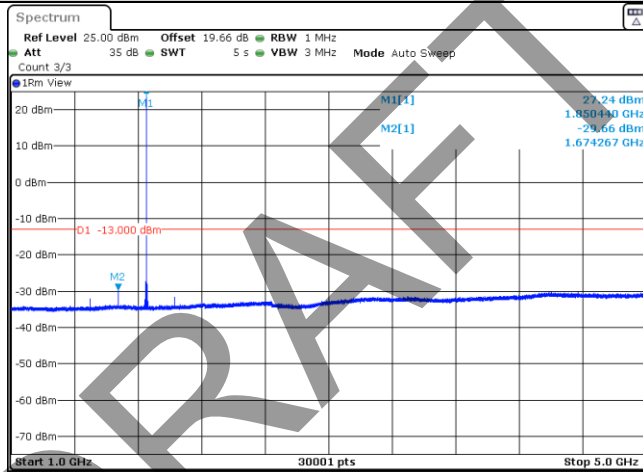

Date: 5.MAR.2024 09:18:28

Band25-3MHz-QPSK-26055-1-0-Low-1000-5000--29.66-PASS

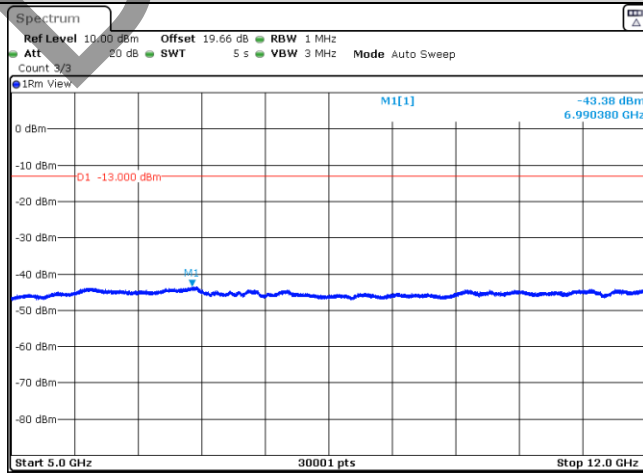

Date: 5.MAR.2024 09:18:49

Band25-3MHz-QPSK-26055-1-0-Low-5000-12000--43.38-PASS

BV 7Layers Communications Technology (Shenzhen) Co., Ltd

Room B37, Warehouse A5, No.3 Chiwan 4th Road, Zhaoshang Street, Nanshan District Shenzhen, Guangdong, People's Republic of China

Tel: +86 755 8869 6566 Fax: +86 755 8869 6577

Email: customerservice.sw@bureauveritas.com



BUREAU VERITAS

Test Report No.: W7L-P23120015R102

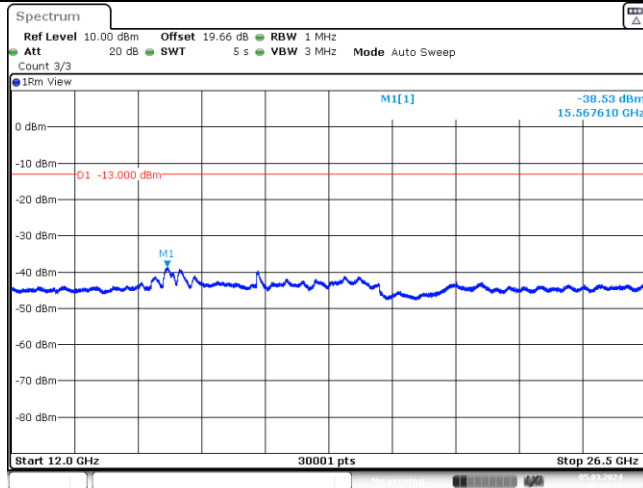

Date: 5.MAR.2024 09:19:11

Band25-3MHz-QPSK-26055-1-0-Low-12000-26500--38.53-PASS

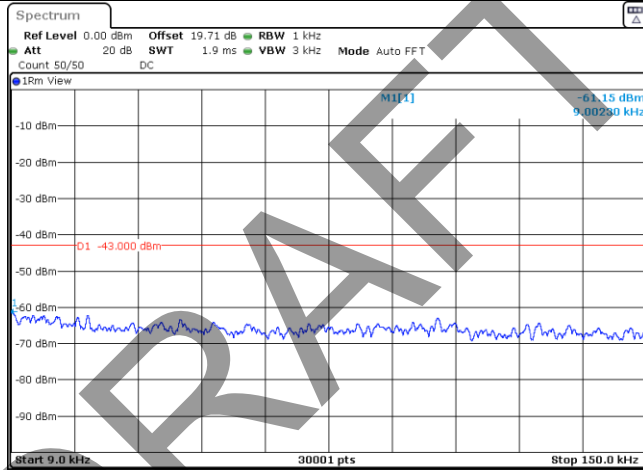

Date: 5.MAR.2024 09:20:38

Band25-3MHz-QPSK-26365-1-0-Low-0.009-0.15--61.15-PASS

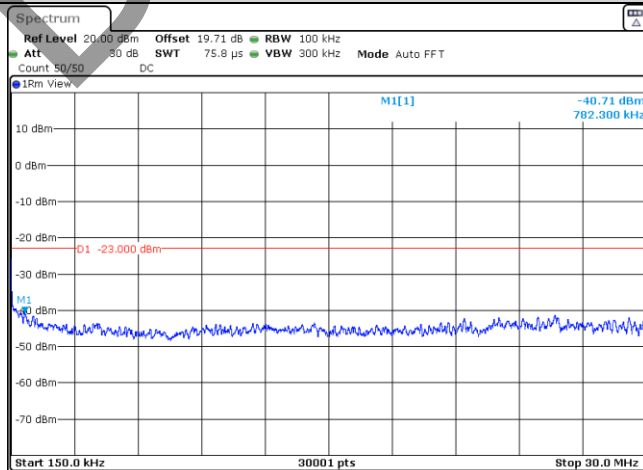

Date: 5.MAR.2024 09:20:43

Band25-3MHz-QPSK-26365-1-0-Low-0.15-30--40.71-PASS

BV 7Layers Communications Technology (Shenzhen) Co., Ltd

Room B37, Warehouse A5, No.3 Chiwan 4th Road, Zhaoshang Street, Nanshan District Shenzhen, Guangdong, People's Republic of China

Tel: +86 755 8869 6566 Fax: +86 755 8869 6577

Email: customerservice.sw@bureauveritas.com



BUREAU VERITAS

Test Report No.: W7L-P23120015R102

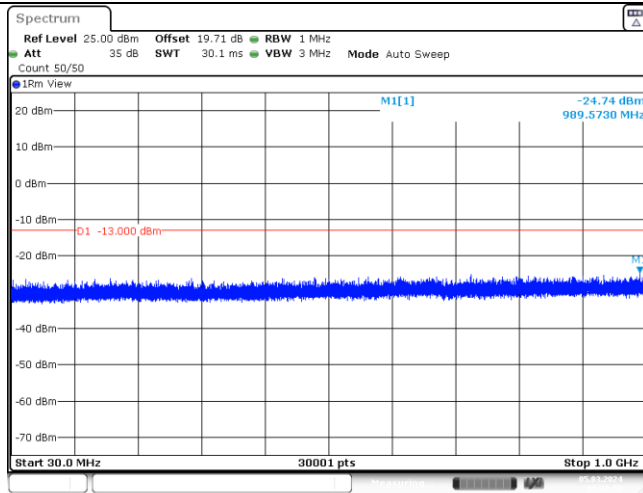

Date: 5.MAR.2024 09:20:50

Band25-3MHz-QPSK-26365-1-0-Low-30-1000--24.74-PASS

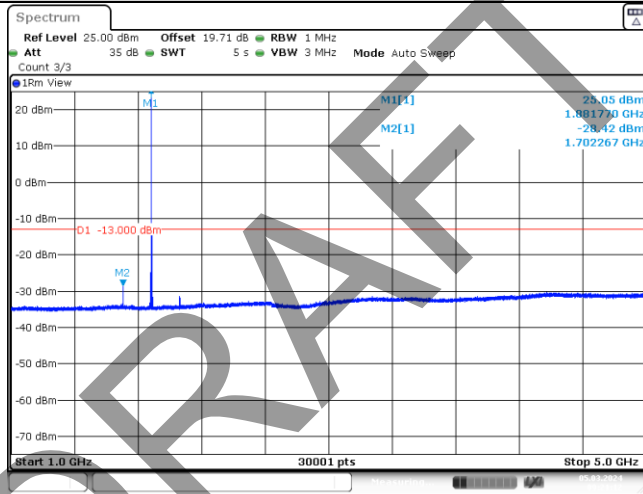

Date: 5.MAR.2024 09:21:12

Band25-3MHz-QPSK-26365-1-0-Low-1000-5000--28.42-PASS

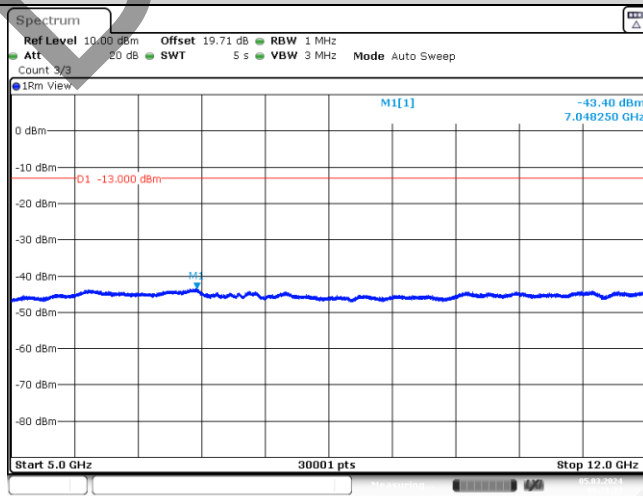

Date: 5.MAR.2024 09:21:33

Band25-3MHz-QPSK-26365-1-0-Low-5000-12000--43.4-PASS

BV 7Layers Communications Technology (Shenzhen) Co., Ltd

Room B37, Warehouse A5, No.3 Chiwan 4th Road, Zhaoshang Street, Nanshan District Shenzhen, Guangdong, People's Republic of China

Tel: +86 755 8869 6566 Fax: +86 755 8869 6577 Email: customerservice.sw@bureauveritas.com



BUREAU VERITAS

Test Report No.: W7L-P23120015R102

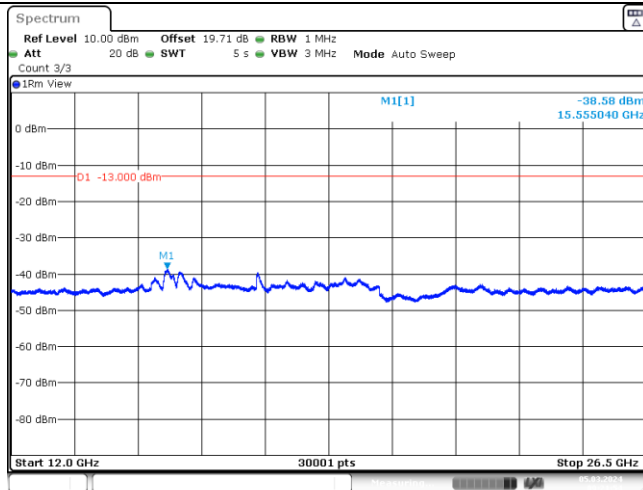

Date: 5.MAR.2024 09:21:54

Band25-3MHz-QPSK-26365-1-0-Low-12000-26500--38.58-PASS

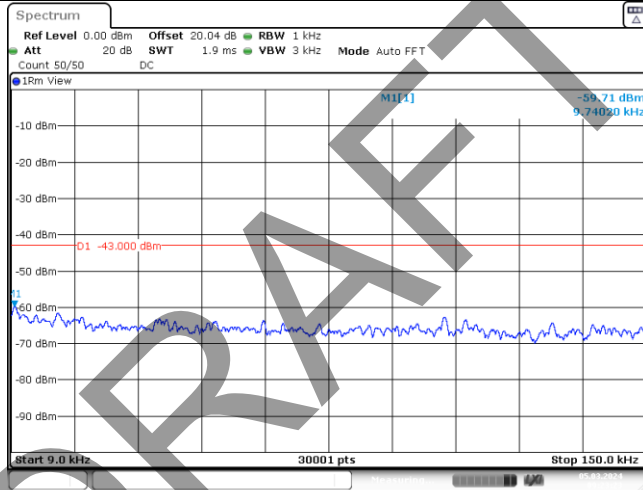

Date: 5.MAR.2024 09:23:23

Band25-3MHz-QPSK-26675-1-0-High-0.009-0.15--59.71-PASS

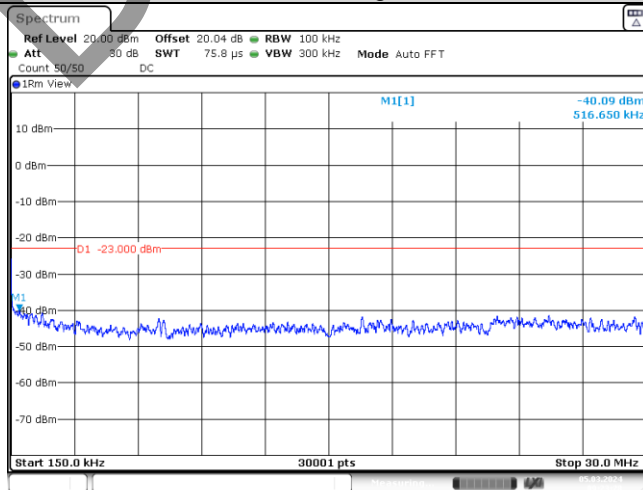

Date: 5.MAR.2024 09:23:28

Band25-3MHz-QPSK-26675-1-0-High-0.15-30--40.09-PASS

BV 7Layers Communications Technology (Shenzhen) Co., Ltd

Room B37, Warehouse A5, No.3 Chiwan 4th Road, Zhaoshang Street, Nanshan District Shenzhen, Guangdong, People's Republic of China

Tel: +86 755 8869 6566 Fax: +86 755 8869 6577

Email: customerservice.sw@bureauveritas.com



BUREAU VERITAS

Test Report No.: W7L-P23120015R102

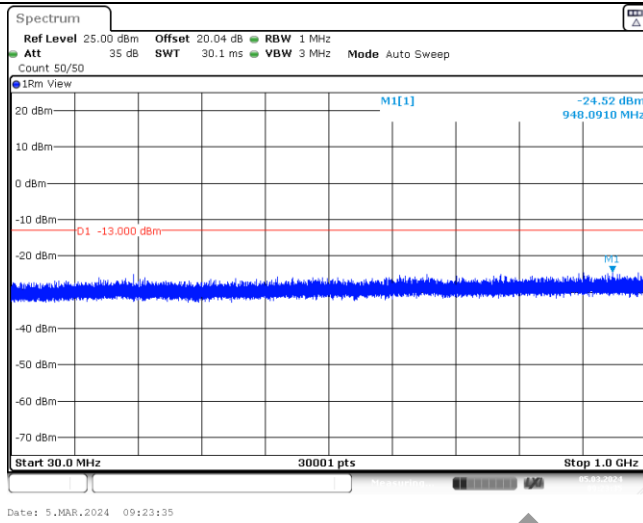

Band25-3MHz-QPSK-26675-1-0-High-30-1000--24.52-PASS

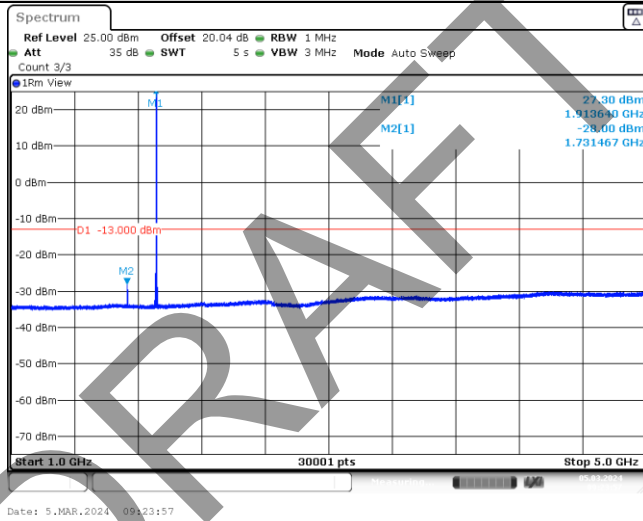

Band25-3MHz-QPSK-26675-1-0-High-1000-5000--28-PASS

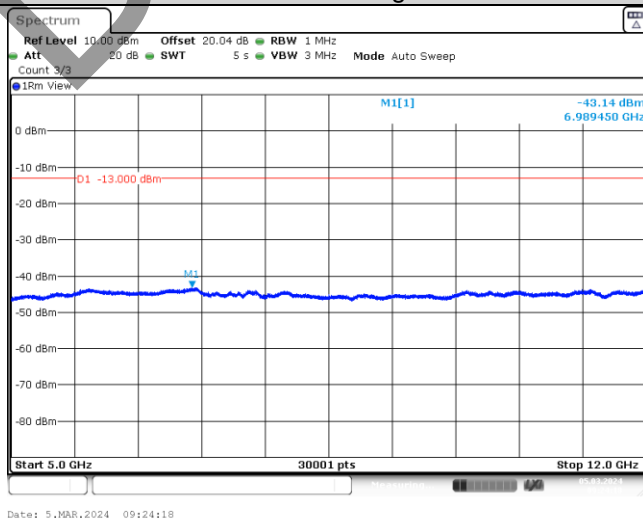

Band25-3MHz-QPSK-26675-1-0-High-5000-12000--43.14-PASS

BV 7Layers Communications Technology (Shenzhen) Co., Ltd

Room B37, Warehouse A5, No.3 Chiwan 4th Road, Zhaoshang Street, Nanshan District Shenzhen, Guangdong, People's Republic of China

Tel: +86 755 8869 6566 Fax: +86 755 8869 6577

Email: customerservice.sw@bureauveritas.com



BUREAU VERITAS

Test Report No.: W7L-P23120015R102

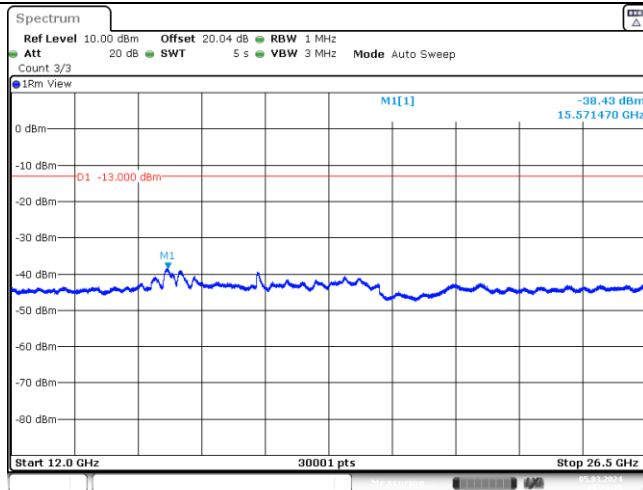

Date: 5.MAR.2024 09:24:39

Band25-3MHz-QPSK-26675-1-0-High-12000-26500--38.43-PASS

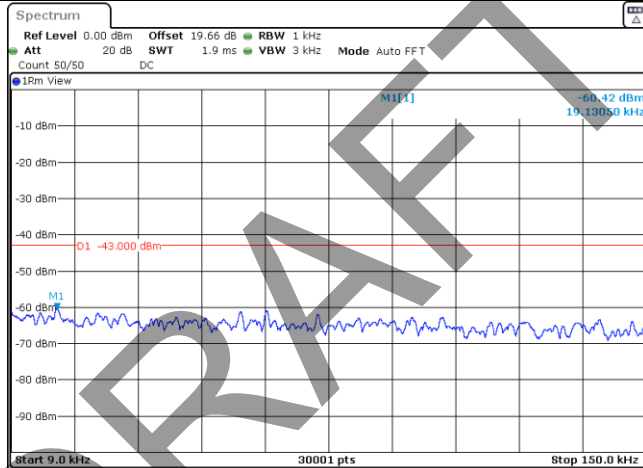

Date: 5.MAR.2024 09:19:16

Band25-3MHz-16QAM-26055-1-0-Low-0.009-0.15--60.42-PASS

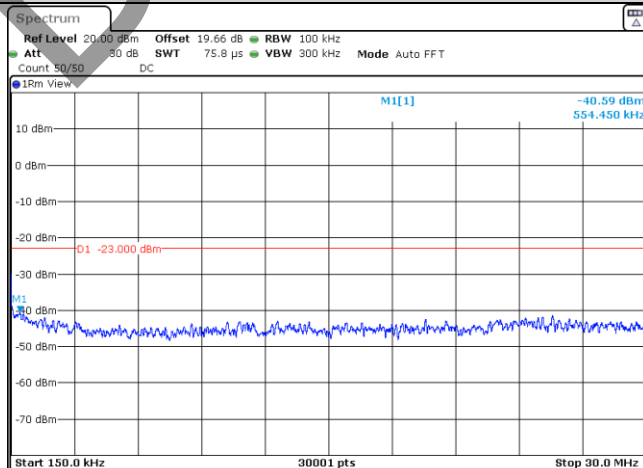

Date: 5.MAR.2024 09:19:20

Band25-3MHz-16QAM-26055-1-0-Low-0.15-30--40.59-PASS

BV 7Layers Communications Technology (Shenzhen) Co., Ltd

Room B37, Warehouse A5, No.3 Chiwan 4th Road, Zhaoshang Street, Nanshan District Shenzhen, Guangdong, People's Republic of China

Tel: +86 755 8869 6566 Fax: +86 755 8869 6577

Email: customerservice.sw@bureauveritas.com



BUREAU VERITAS

Test Report No.: W7L-P23120015R102

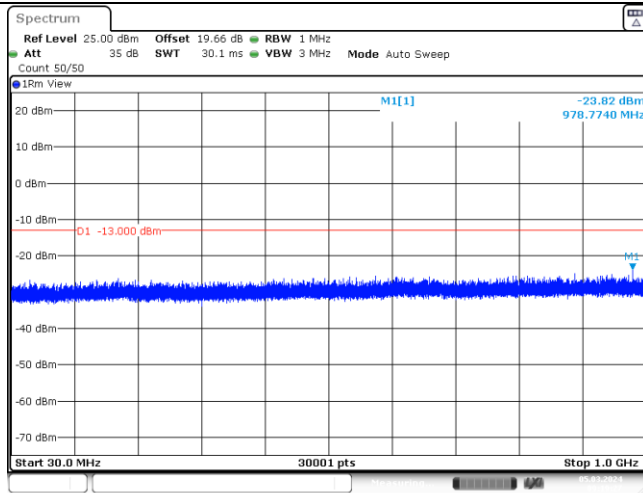

Date: 5.MAR.2024 09:19:27

Band25-3MHz-16QAM-26055-1-0-Low-30-1000--23.82-PASS



Date: 5.MAR.2024 09:19:49

Band25-3MHz-16QAM-26055-1-0-Low-1000-5000--30.31-PASS

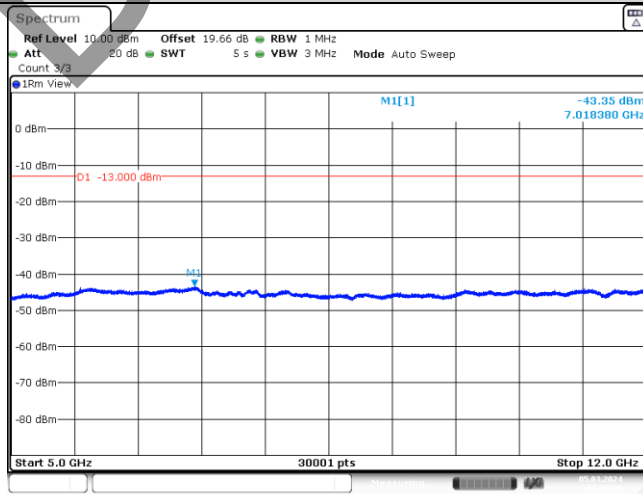

Date: 5.MAR.2024 09:20:10

Band25-3MHz-16QAM-26055-1-0-Low-5000-12000--43.35-PASS

BV 7Layers Communications Technology (Shenzhen) Co., Ltd

Room B37, Warehouse A5, No.3 Chiwan 4th Road, Zhaoshang Street, Nanshan District Shenzhen, Guangdong, People's Republic of China

Tel: +86 755 8869 6566 Fax: +86 755 8869 6577

Email: customerservice.sw@bureauveritas.com



BUREAU VERITAS

Test Report No.: W7L-P23120015R102

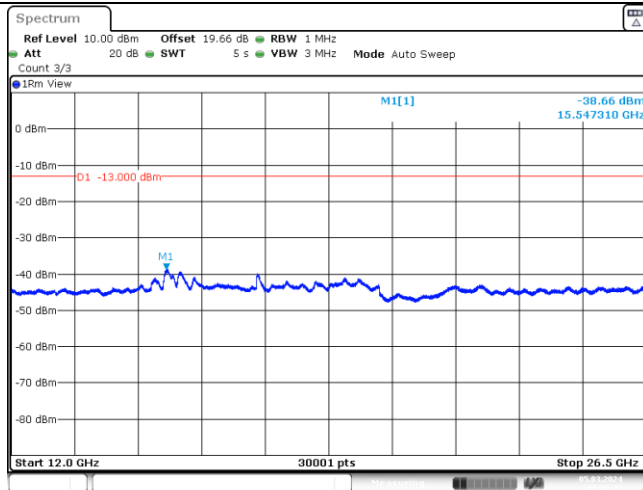

Date: 5.MAR.2024 09:20:32

Band25-3MHz-16QAM-26055-1-0-Low-12000-26500--38.66-PASS

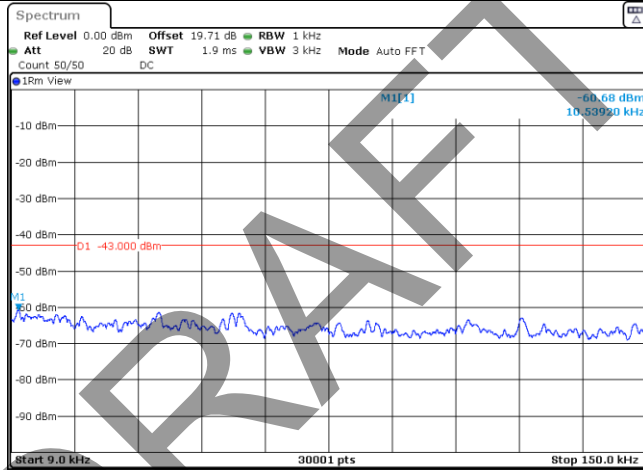

Date: 5.MAR.2024 09:21:59

Band25-3MHz-16QAM-26365-1-0-Low-0.009-0.15--60.68-PASS

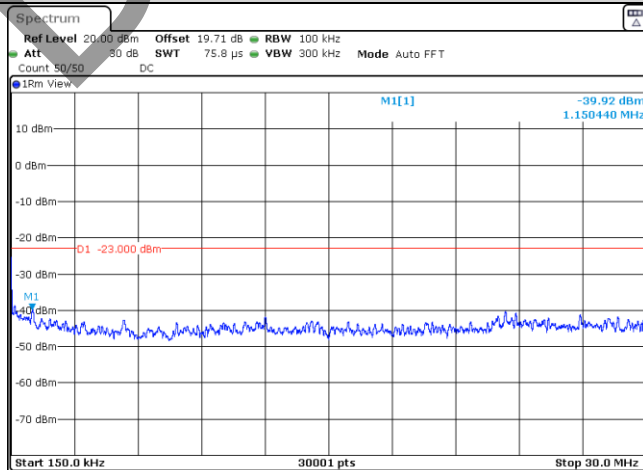

Date: 5.MAR.2024 09:22:04

Band25-3MHz-16QAM-26365-1-0-Low-0.15-30--39.92-PASS

BV 7Layers Communications Technology (Shenzhen) Co., Ltd

Room B37, Warehouse A5, No.3 Chiwan 4th Road, Zhaoshang Street, Nanshan District Shenzhen, Guangdong, People's Republic of China

Tel: +86 755 8869 6566 Fax: +86 755 8869 6577

Email: customerservice.sw@bureauveritas.com



BUREAU VERITAS

Test Report No.: W7L-P23120015R102

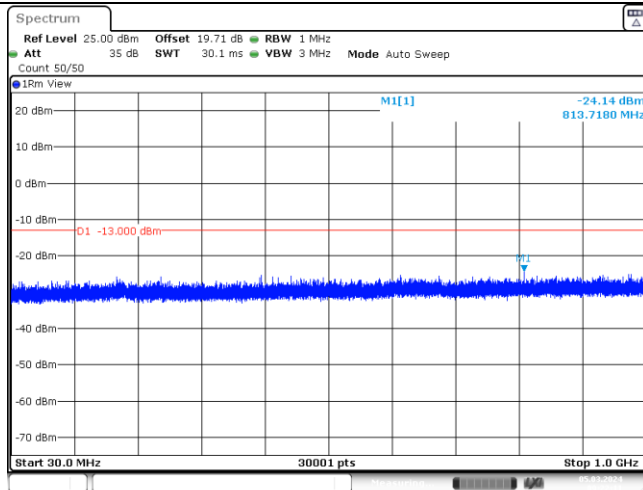

Date: 5.MAR.2024 09:22:11

Band25-3MHz-16QAM-26365-1-0-Low-30-1000--24.14-PASS

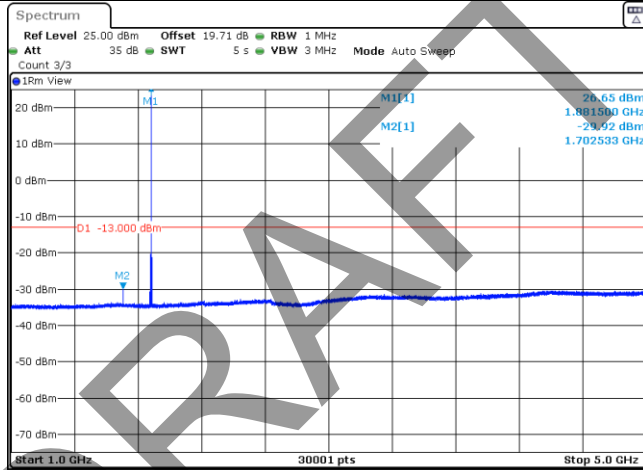

Date: 5.MAR.2024 09:22:33

Band25-3MHz-16QAM-26365-1-0-Low-1000-5000--29.92-PASS

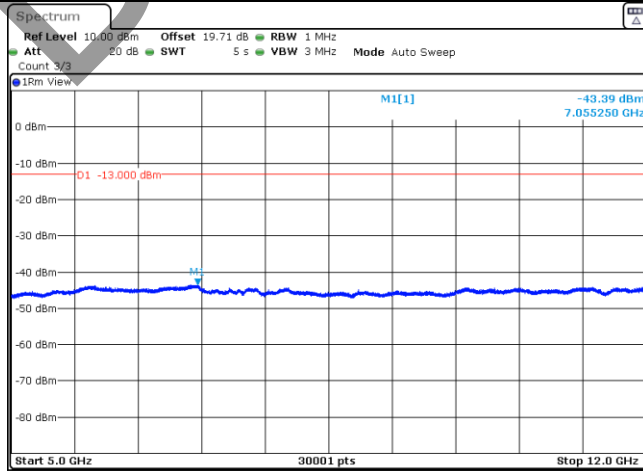

Date: 5.MAR.2024 09:22:54

Band25-3MHz-16QAM-26365-1-0-Low-5000-12000--43.39-PASS

BV 7Layers Communications Technology (Shenzhen) Co., Ltd

Room B37, Warehouse A5, No.3 Chiwan 4th Road, Zhaoshang Street, Nanshan District Shenzhen, Guangdong, People's Republic of China

Tel: +86 755 8869 6566
 Fax: +86 755 8869 6577
 Email: customerservice.sw@bureauveritas.com



BUREAU VERITAS

Test Report No.: W7L-P23120015R102

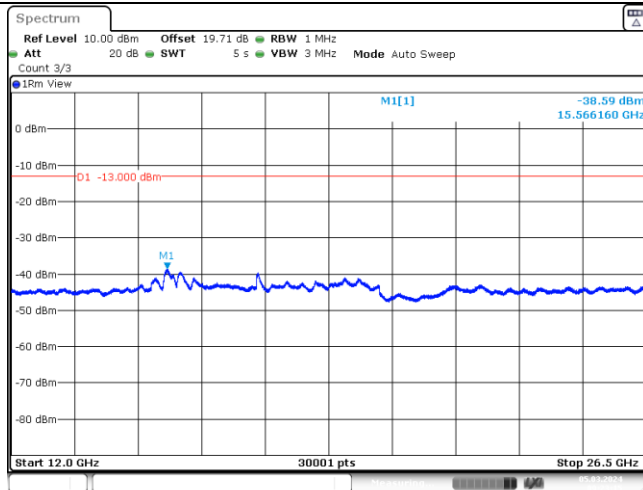

Date: 5.MAR.2024 09:23:15

Band25-3MHz-16QAM-26365-1-0-Low-12000-26500--38.59-PASS

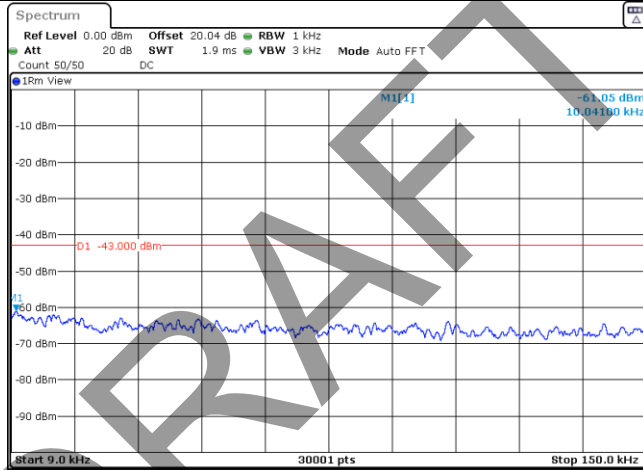

Date: 5.MAR.2024 09:24:44

Band25-3MHz-16QAM-26675-1-0-High-0.009-0.15--61.05-PASS

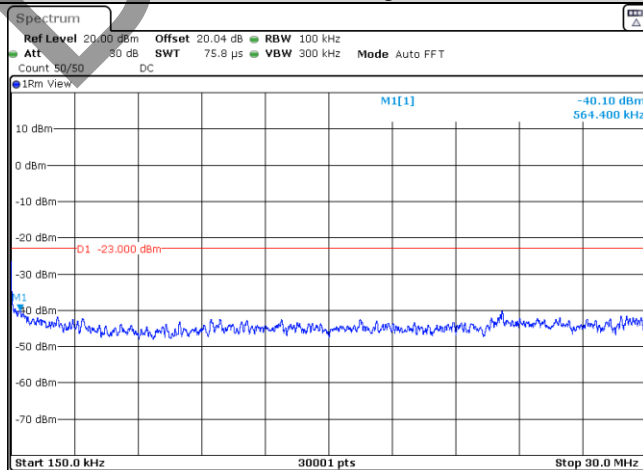

Date: 5.MAR.2024 09:24:49

Band25-3MHz-16QAM-26675-1-0-High-0.15-30--40.1-PASS

BV 7Layers Communications Technology (Shenzhen) Co., Ltd

Room B37, Warehouse A5, No.3 Chiwan 4th Road, Zhaoshang Street, Nanshan District Shenzhen, Guangdong, People's Republic of China

Tel: +86 755 8869 6566 Fax: +86 755 8869 6577

Email: customerservice.sw@bureauveritas.com



BUREAU VERITAS

Test Report No.: W7L-P23120015R102

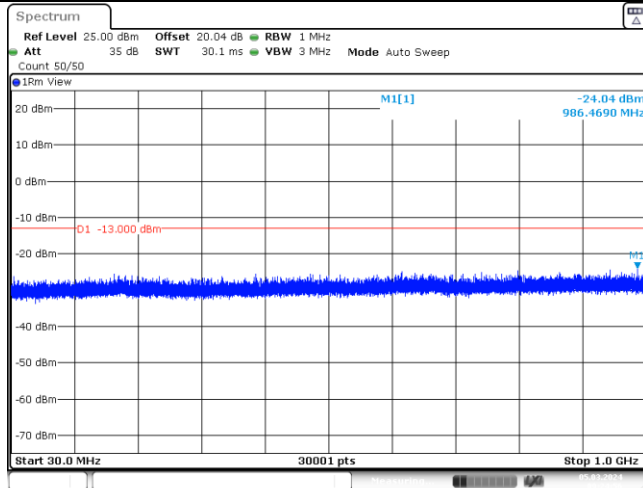

Date: 5.MAR.2024 09:24:56

Band25-3MHz-16QAM-26675-1-0-High-30-1000--24.04-PASS

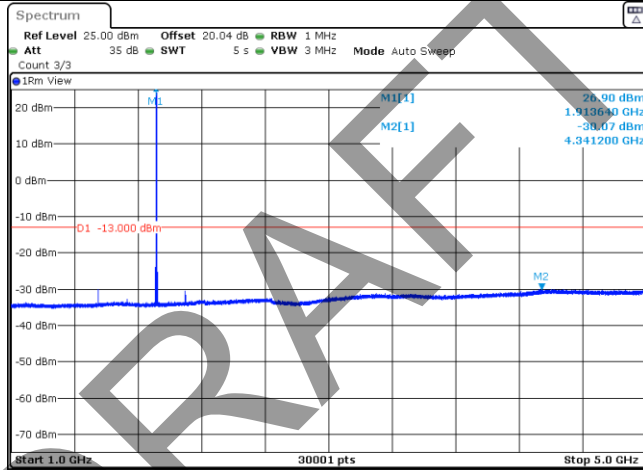

Date: 5.MAR.2024 09:25:18

Band25-3MHz-16QAM-26675-1-0-High-1000-5000--30.07-PASS

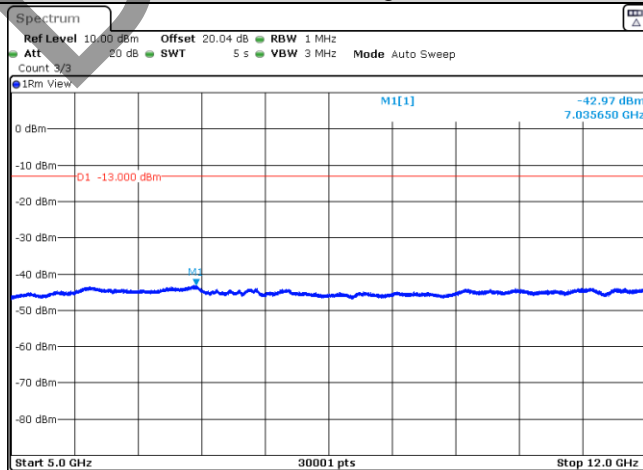

Date: 5.MAR.2024 09:25:39

Band25-3MHz-16QAM-26675-1-0-High-5000-12000--42.97-PASS

BV 7Layers Communications Technology (Shenzhen) Co., Ltd

Room B37, Warehouse A5, No.3 Chiwan 4th Road, Zhaoshang Street, Nanshan District Shenzhen, Guangdong, People's Republic of China

Tel: +86 755 8869 6566 Fax: +86 755 8869 6577

Email: customerservice.sw@bureauveritas.com



BUREAU VERITAS

Test Report No.: W7L-P23120015R102

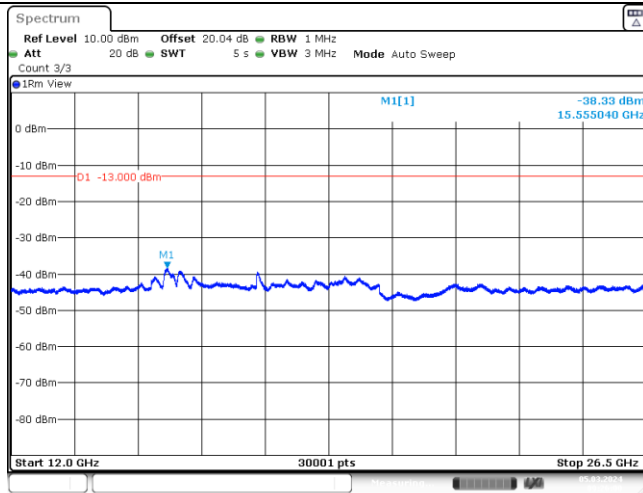

Band25-3MHz-16QAM-26675-1-0-High-12000-26500--38.33-PASS

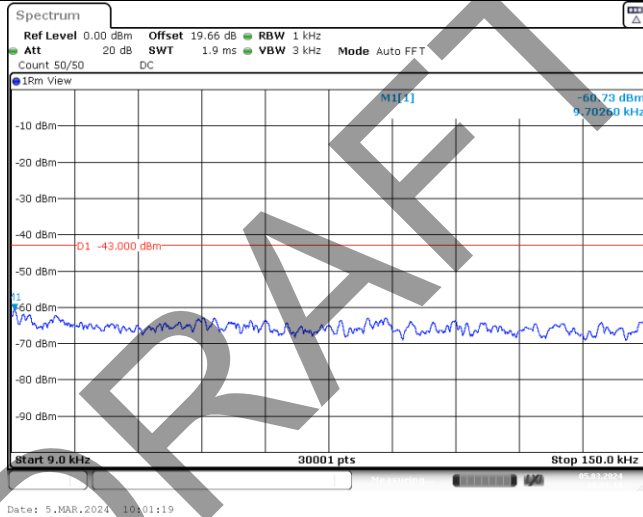

Band25-5MHz-QPSK-26065-1-0-Low-0.009-0.15--60.73-PASS

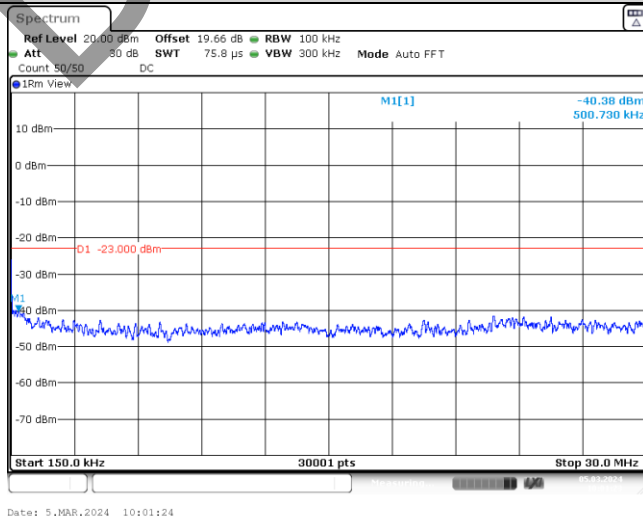

Band25-5MHz-QPSK-26065-1-0-Low-0.15-30--40.38-PASS



BUREAU VERITAS

Test Report No.: W7L-P23120015R102

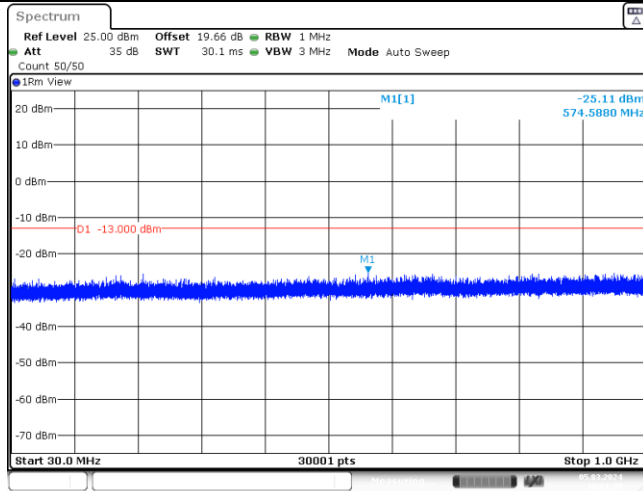

Band25-5MHz-QPSK-26065-1-0-Low-30-1000--25.11-PASS

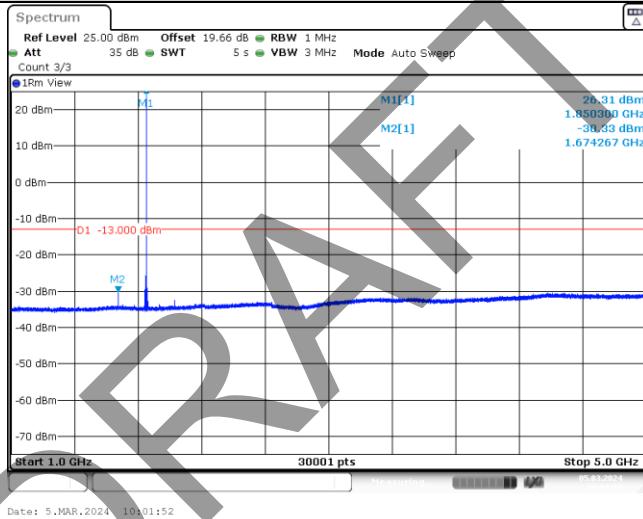

Band25-5MHz-QPSK-26065-1-0-Low-1000-5000--30.33-PASS

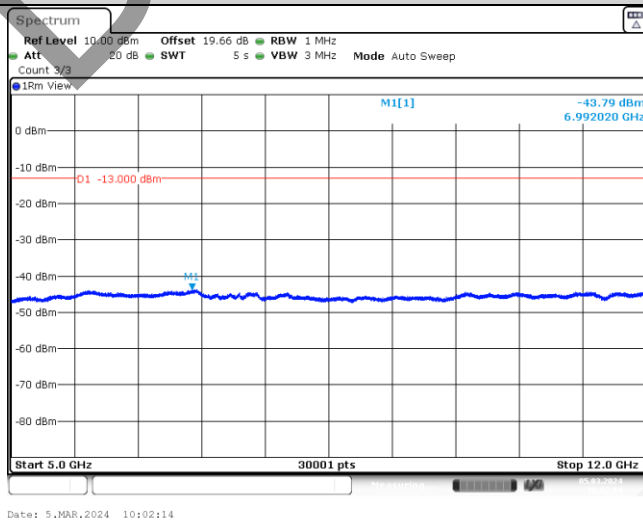

Band25-5MHz-QPSK-26065-1-0-Low-5000-12000--43.79-PASS

BV 7Layers Communications Technology (Shenzhen) Co., Ltd

Room B37, Warehouse A5, No.3 Chiwan 4th Road, Zhaoshang Street, Nanshan District Shenzhen, Guangdong, People's Republic of China

Tel: +86 755 8869 6566
Fax: +86 755 8869 6577
Email: customerservice.sw@bureauveritas.com



BUREAU VERITAS

Test Report No.: W7L-P23120015R102

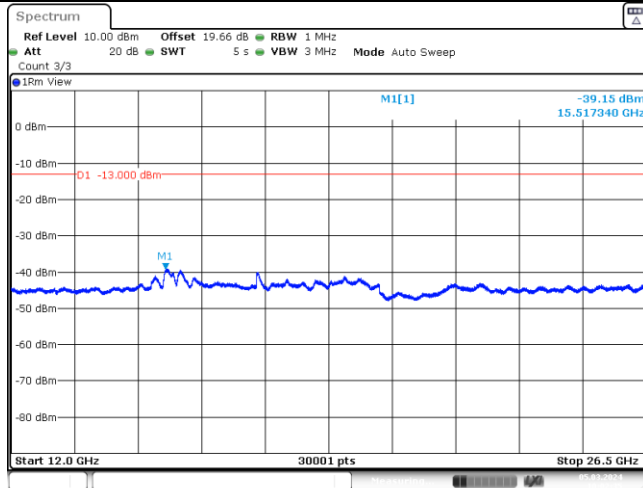

Date: 5.MAR.2024 10:02:35

Band25-5MHz-QPSK-26065-1-0-Low-12000-26500--39.15-PASS

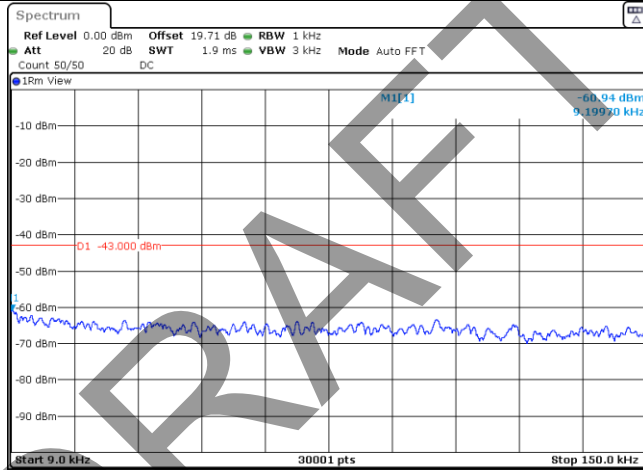

Date: 5.MAR.2024 10:04:14

Band25-5MHz-QPSK-26365-1-0-Low-0.009-0.15--60.94-PASS

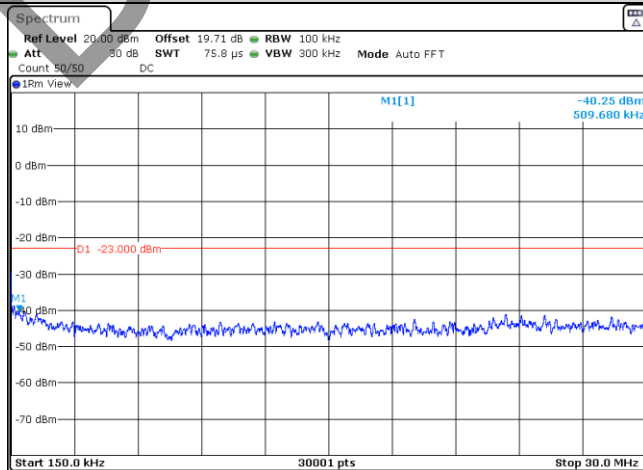

Date: 5.MAR.2024 10:04:19

Band25-5MHz-QPSK-26365-1-0-Low-0.15-30--40.25-PASS

BV 7Layers Communications Technology (Shenzhen) Co., Ltd

Room B37, Warehouse A5, No.3 Chiwan 4th Road, Zhaoshang Street, Nanshan District Shenzhen, Guangdong, People's Republic of China

Tel: +86 755 8869 6566 Fax: +86 755 8869 6577

Email: customerservice.sw@bureauveritas.com



BUREAU VERITAS

Test Report No.: W7L-P23120015R102

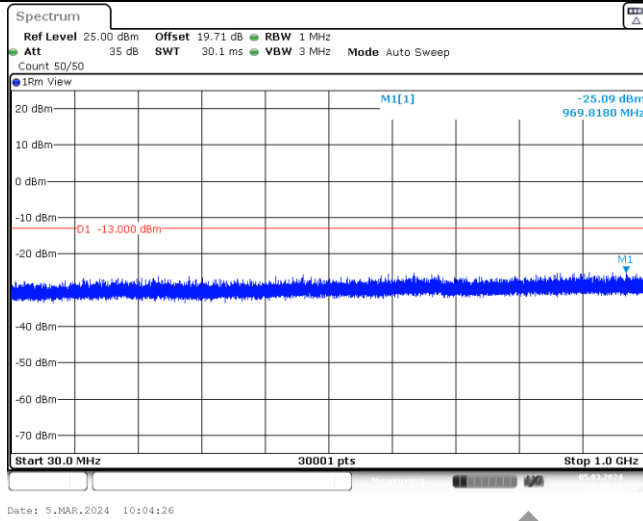

Band25-5MHz-QPSK-26365-1-0-Low-30-1000--25.09-PASS

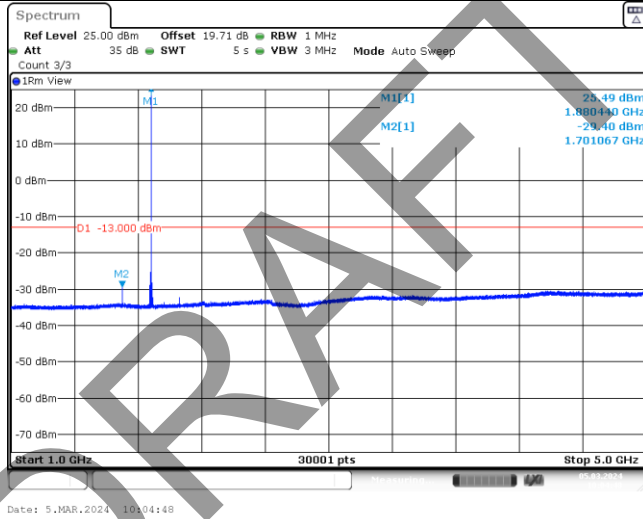

Band25-5MHz-QPSK-26365-1-0-Low-1000-5000--29.4-PASS

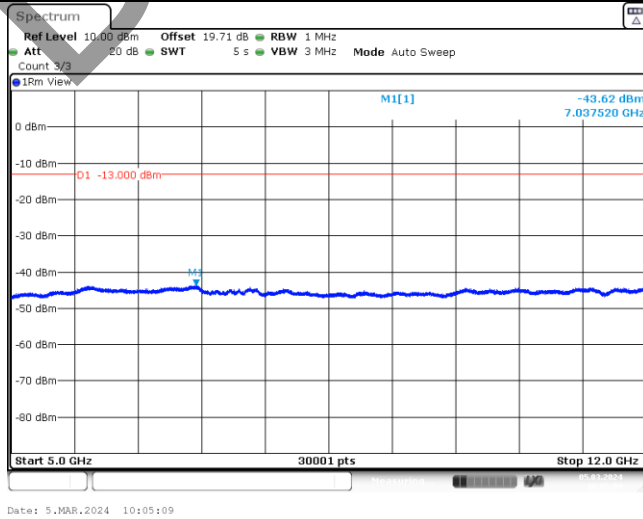

Band25-5MHz-QPSK-26365-1-0-Low-5000-12000--43.62-PASS

BV 7Layers Communications Technology (Shenzhen) Co., Ltd

Room B37, Warehouse A5, No.3 Chiwan 4th Road, Zhaoshang Street, Nanshan District Shenzhen, Guangdong, People's Republic of China

Tel: +86 755 8869 6566
 Fax: +86 755 8869 6577
 Email: customerservice.sw@bureauveritas.com



BUREAU VERITAS

Test Report No.: W7L-P23120015R102

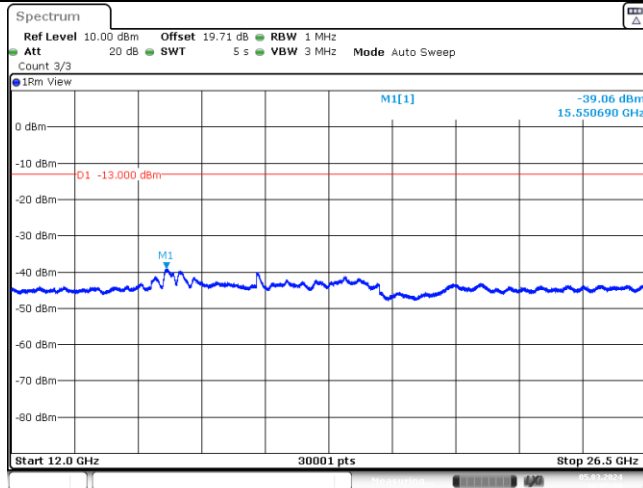

Date: 5.MAR.2024 10:05:30

Band25-5MHz-QPSK-26365-1-0-Low-12000-26500--39.06-PASS

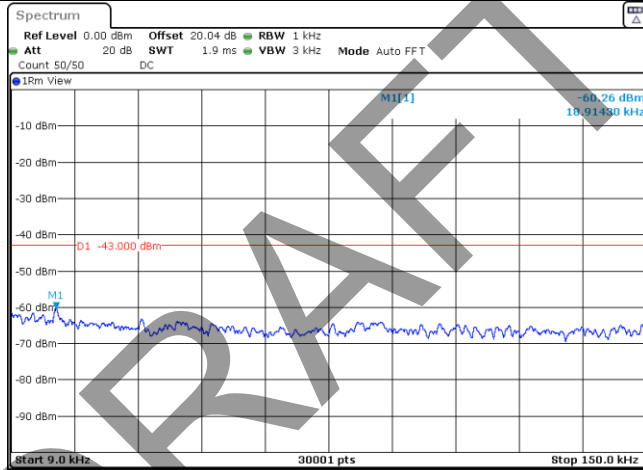

Date: 5.MAR.2024 10:07:00

Band25-5MHz-QPSK-26665-1-0-High-0.009-0.15--60.26-PASS

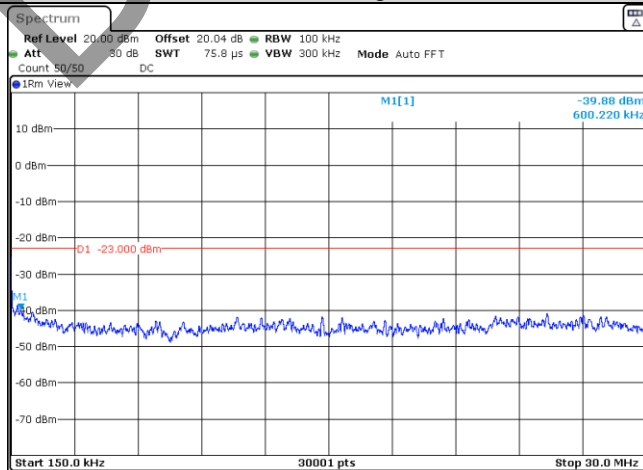

Date: 5.MAR.2024 10:07:04

Band25-5MHz-QPSK-26665-1-0-High-0.15-30--39.88-PASS

BV 7Layers Communications Technology (Shenzhen) Co., Ltd

Room B37, Warehouse A5, No.3 Chiwan 4th Road, Zhaoshang Street, Nanshan District Shenzhen, Guangdong, People's Republic of China

Tel: +86 755 8869 6566 Fax: +86 755 8869 6577

Email: customerservice.sw@bureauveritas.com



BUREAU VERITAS

Test Report No.: W7L-P23120015R102

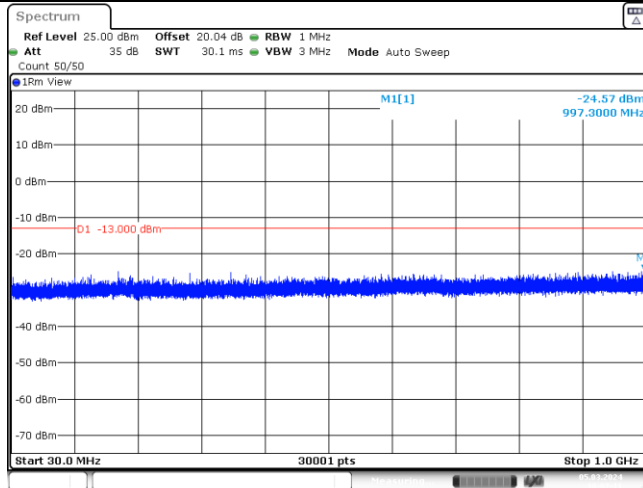

Date: 5.MAR.2024 10:07:11

Band25-5MHz-QPSK-26665-1-0-High-30-1000--24.57-PASS

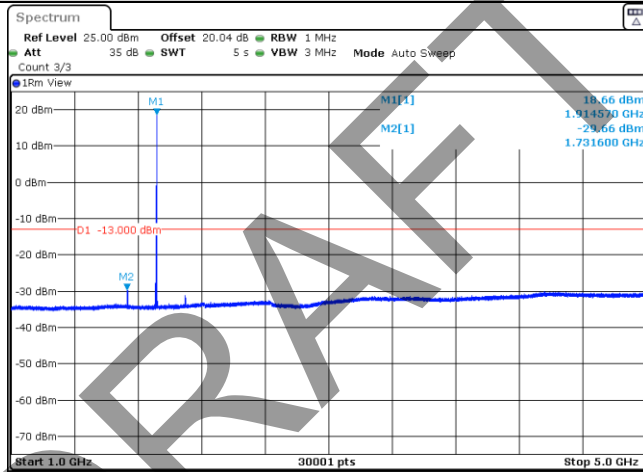

Date: 5.MAR.2024 10:07:33

Band25-5MHz-QPSK-26665-1-0-High-1000-5000--29.66-PASS

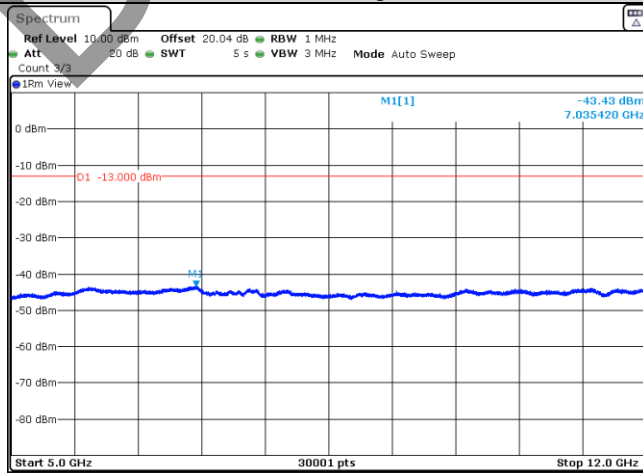

Date: 5.MAR.2024 10:07:54

Band25-5MHz-QPSK-26665-1-0-High-5000-12000--43.43-PASS

BV 7Layers Communications Technology (Shenzhen) Co., Ltd

Room B37, Warehouse A5, No.3 Chiwan 4th Road, Zhaoshang Street, Nanshan District Shenzhen, Guangdong, People's Republic of China

Tel: +86 755 8869 6566 Fax: +86 755 8869 6577

Email: customerservice.sw@bureauveritas.com



BUREAU VERITAS

Test Report No.: W7L-P23120015R102

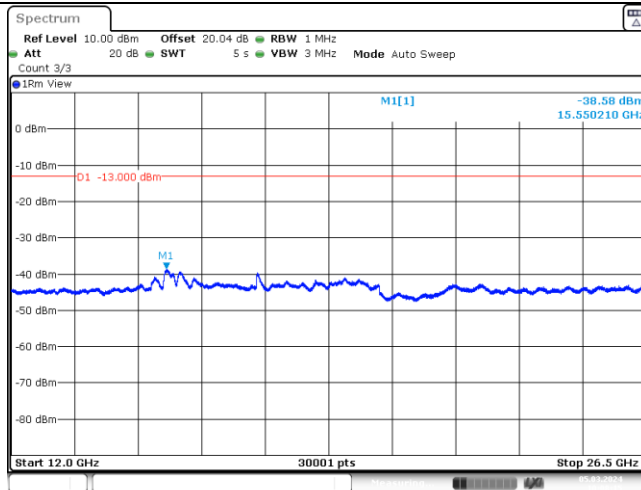

Date: 5.MAR.2024 10:08:15

Band25-5MHz-QPSK-26665-1-0-High-12000-26500--38.58-PASS

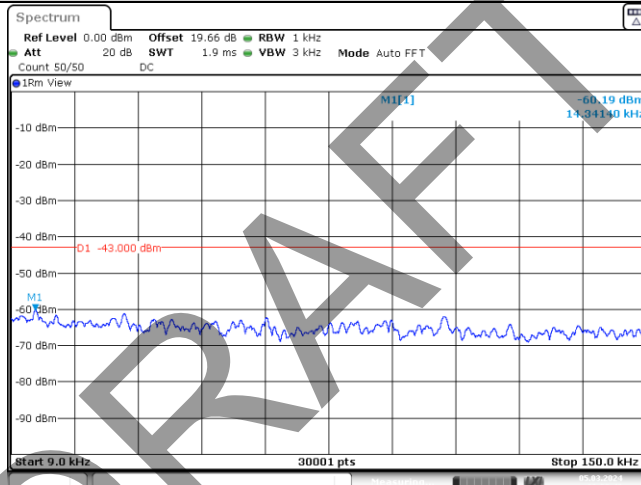

Date: 5.MAR.2024 10:02:40

Band25-5MHz-16QAM-26065-1-0-Low-0.009-0.15--60.19-PASS

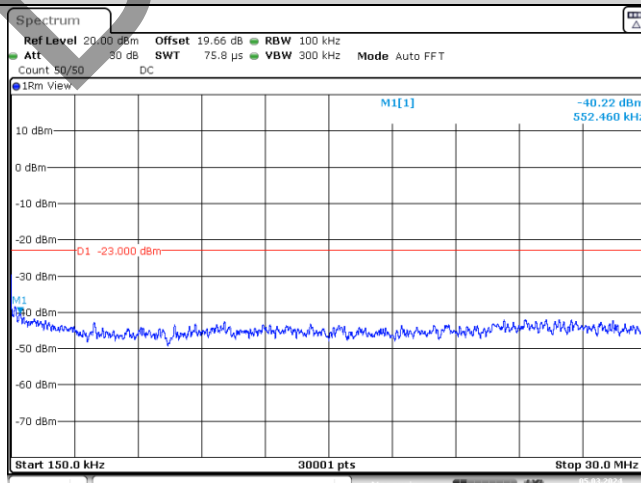

Date: 5.MAR.2024 10:02:45

Band25-5MHz-16QAM-26065-1-0-Low-0.15-30--40.22-PASS

BV 7Layers Communications Technology (Shenzhen) Co., Ltd

Room B37, Warehouse A5, No.3 Chiwan 4th Road, Zhaoshang Street, Nanshan District Shenzhen, Guangdong, People's Republic of China

Tel: +86 755 8869 6566 Fax: +86 755 8869 6577

Email: customerservice.sw@bureauveritas.com



BUREAU VERITAS

Test Report No.: W7L-P23120015R102

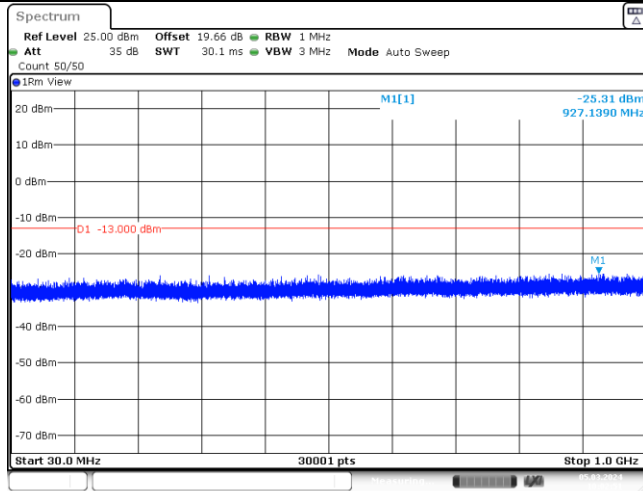

Date: 5.MAR.2024 10:02:51

Band25-5MHz-16QAM-26065-1-0-Low-30-1000--25.31-PASS

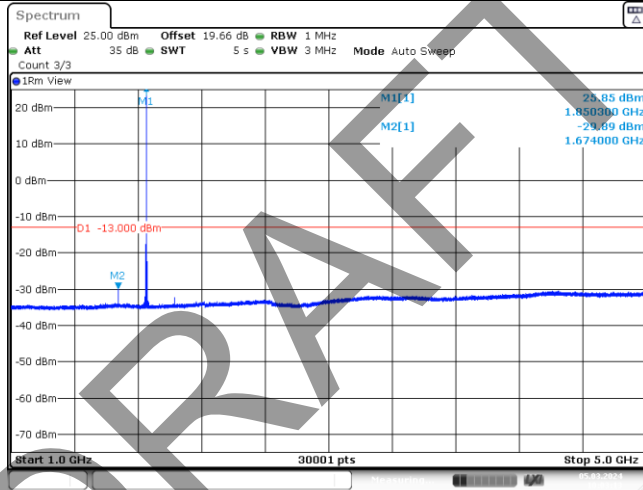

Date: 5.MAR.2024 10:03:13

Band25-5MHz-16QAM-26065-1-0-Low-1000-5000--29.89-PASS

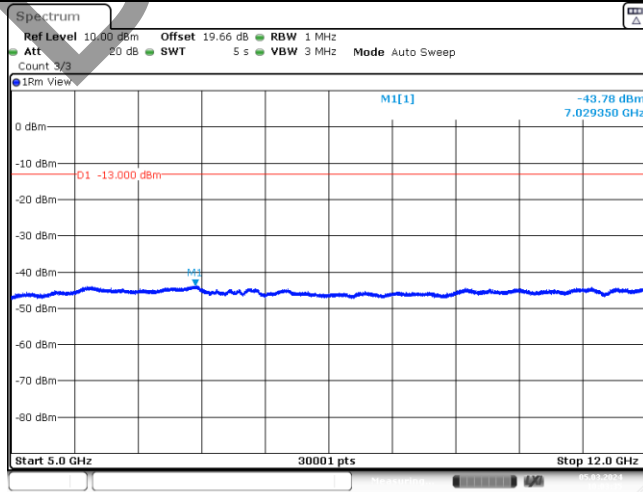

Date: 5.MAR.2024 10:03:35

Band25-5MHz-16QAM-26065-1-0-Low-5000-12000--43.78-PASS

BV 7Layers Communications Technology (Shenzhen) Co., Ltd

Room B37, Warehouse A5, No.3 Chiwan 4th Road, Zhaoshang Street, Nanshan District Shenzhen, Guangdong, People's Republic of China

Tel: +86 755 8869 6566
 Fax: +86 755 8869 6577
 Email: customerservice.sw@bureauveritas.com



BUREAU VERITAS

Test Report No.: W7L-P23120015R102

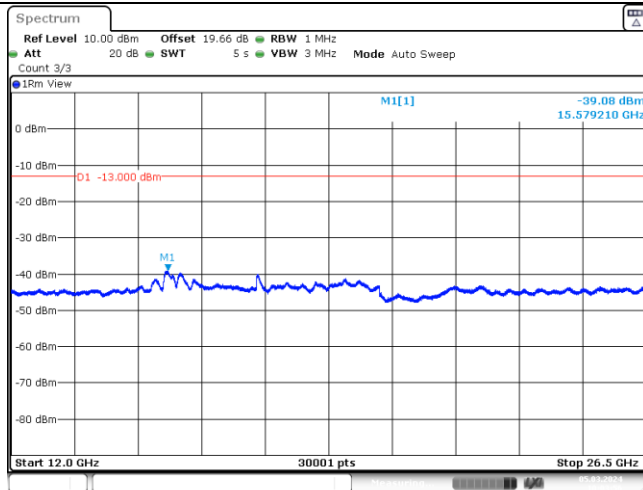

Date: 5.MAR.2024 10:03:56

Band25-5MHz-16QAM-26065-1-0-Low-12000-26500--39.08-PASS

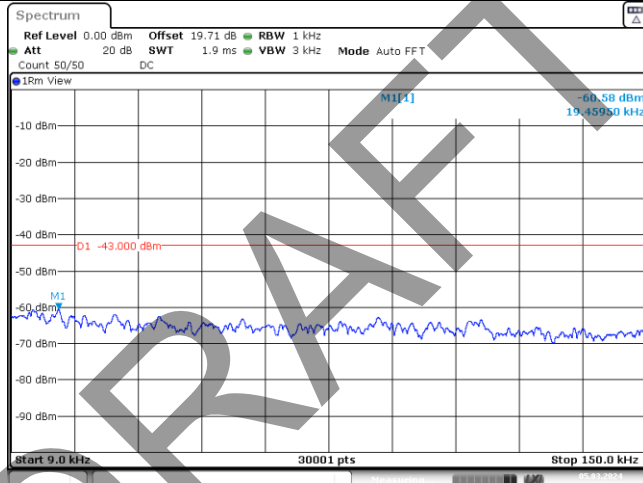

Date: 5.MAR.2024 10:05:36

Band25-5MHz-16QAM-26365-1-0-Low-0.009-0.15--60.58-PASS

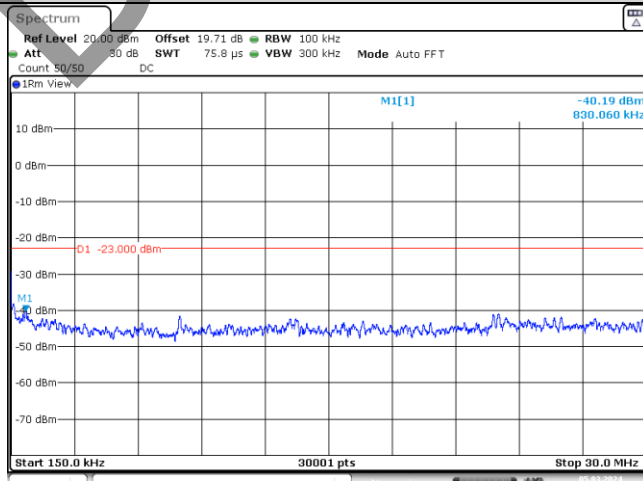

Date: 5.MAR.2024 10:05:40

Band25-5MHz-16QAM-26365-1-0-Low-0.15-30--40.19-PASS

BV 7Layers Communications Technology (Shenzhen) Co., Ltd

Room B37, Warehouse A5, No.3 Chiwan 4th Road, Zhaoshang Street, Nanshan District Shenzhen, Guangdong, People's Republic of China

Tel: +86 755 8869 6566 Fax: +86 755 8869 6577

Email: customerservice.sw@bureauveritas.com



BUREAU VERITAS

Test Report No.: W7L-P23120015R102

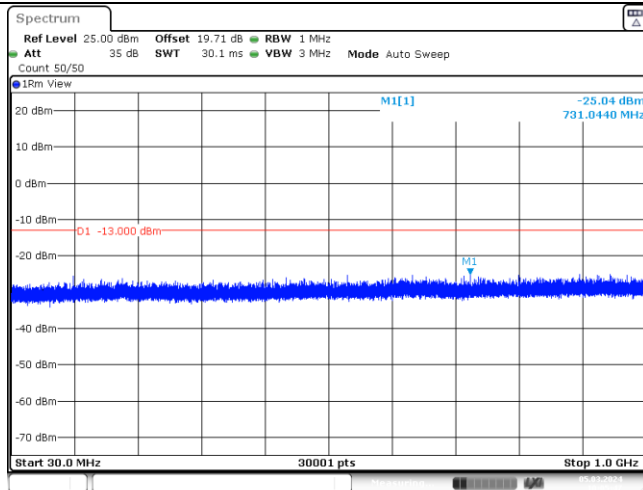

Date: 5.MAR.2024 10:05:47

Band25-5MHz-16QAM-26365-1-0-Low-30-1000--25.04-PASS

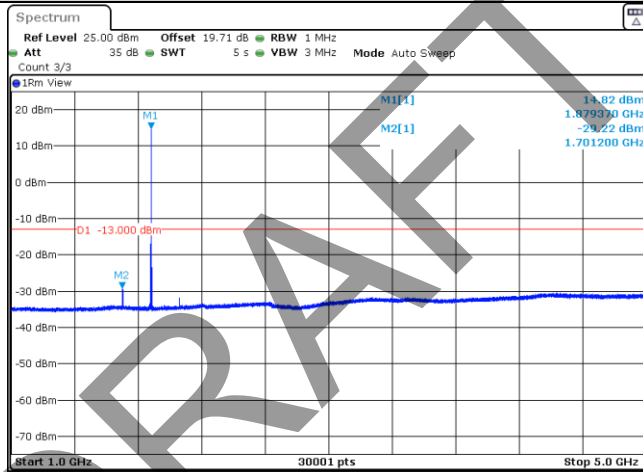

Date: 5.MAR.2024 10:06:09

Band25-5MHz-16QAM-26365-1-0-Low-1000-5000--29.22-PASS

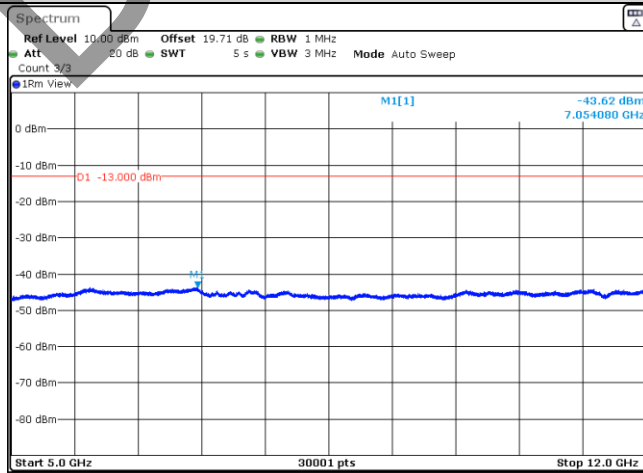

Date: 5.MAR.2024 10:06:30

Band25-5MHz-16QAM-26365-1-0-Low-5000-12000--43.62-PASS

BV 7Layers Communications Technology (Shenzhen) Co., Ltd

Room B37, Warehouse A5, No.3 Chiwan 4th Road, Zhaoshang Street, Nanshan District Shenzhen, Guangdong, People's Republic of China

Tel: +86 755 8869 6566
 Fax: +86 755 8869 6577
 Email: customerservice.sw@bureauveritas.com



BUREAU VERITAS

Test Report No.: W7L-P23120015R102

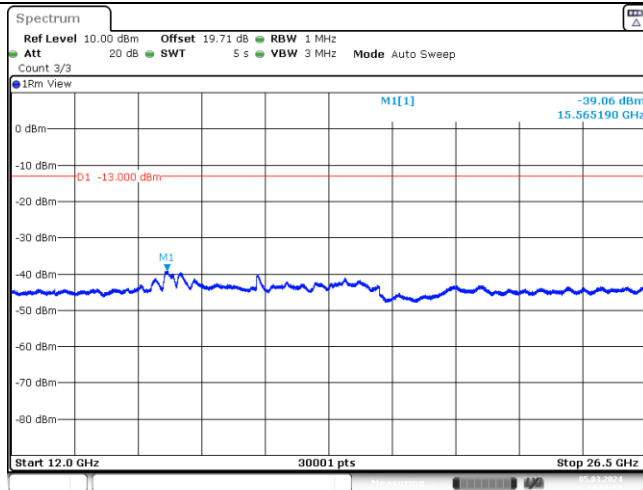

Date: 5.MAR.2024 10:06:51

Band25-5MHz-16QAM-26365-1-0-Low-12000-26500--39.06-PASS

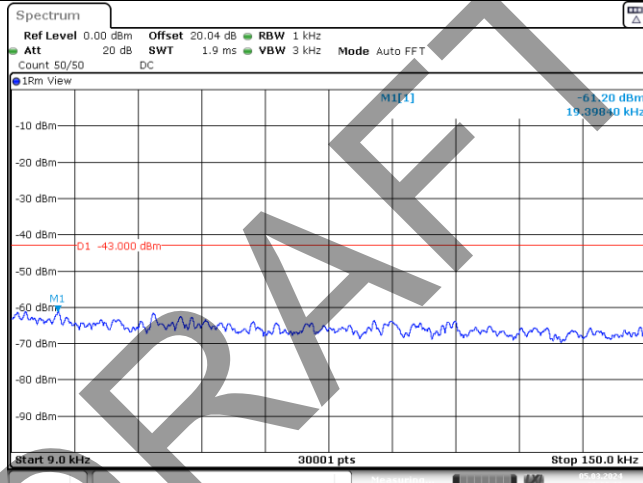

Date: 5.MAR.2024 10:08:21

Band25-5MHz-16QAM-26665-1-0-High-0.009-0.15--61.2-PASS

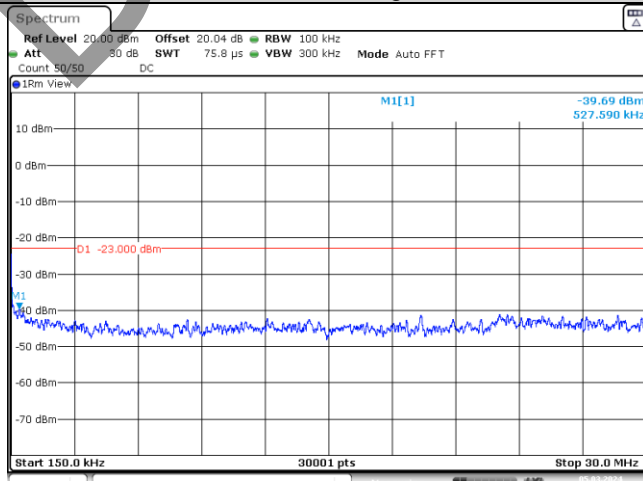

Date: 5.MAR.2024 10:08:25

Band25-5MHz-16QAM-26665-1-0-High-0.15-30--39.69-PASS

BV 7Layers Communications Technology (Shenzhen) Co., Ltd

Room B37, Warehouse A5, No.3 Chiwan 4th Road, Zhaoshang Street, Nanshan District Shenzhen, Guangdong, People's Republic of China

Tel: +86 755 8869 6566 Fax: +86 755 8869 6577

Email: customerservice.sw@bureauveritas.com



BUREAU VERITAS

Test Report No.: W7L-P23120015R102

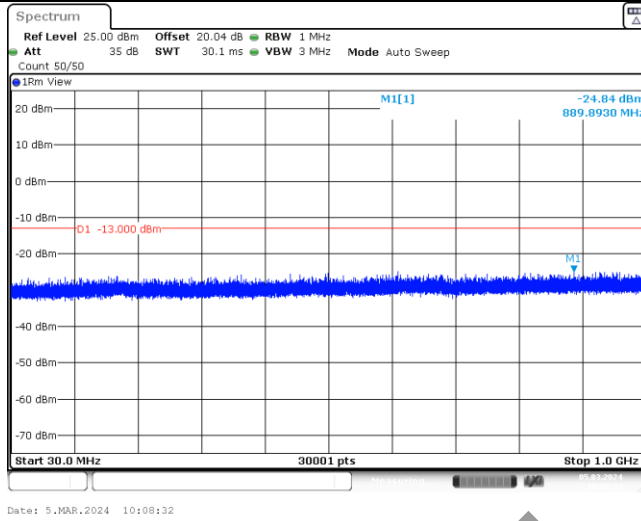

Band25-5MHz-16QAM-26665-1-0-High-30-1000--24.84-PASS

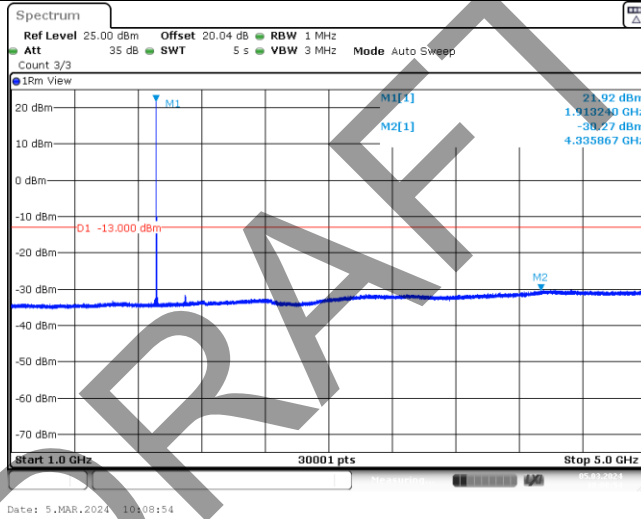

Band25-5MHz-16QAM-26665-1-0-High-1000-5000--30.27-PASS

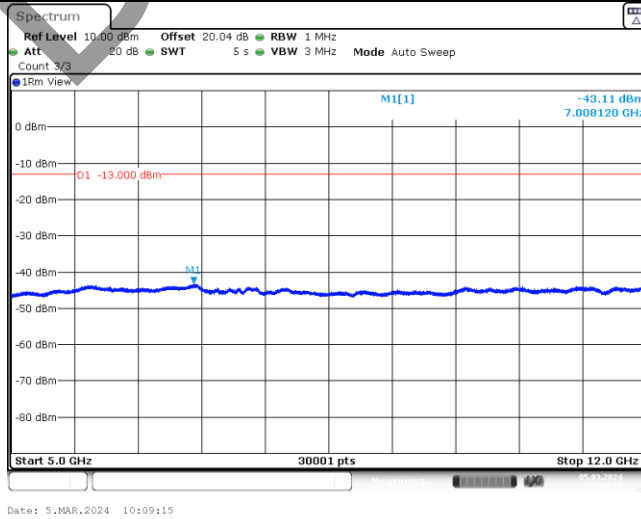

Band25-5MHz-16QAM-26665-1-0-High-5000-12000--43.11-PASS

BV 7Layers Communications Technology (Shenzhen) Co., Ltd

Room B37, Warehouse A5, No.3 Chiwan 4th Road, Zhaoshang Street, Nanshan District Shenzhen, Guangdong, People's Republic of China

Tel: +86 755 8869 6566
 Fax: +86 755 8869 6577
 Email: customerservice.sw@bureauveritas.com



BUREAU VERITAS

Test Report No.: W7L-P23120015R102

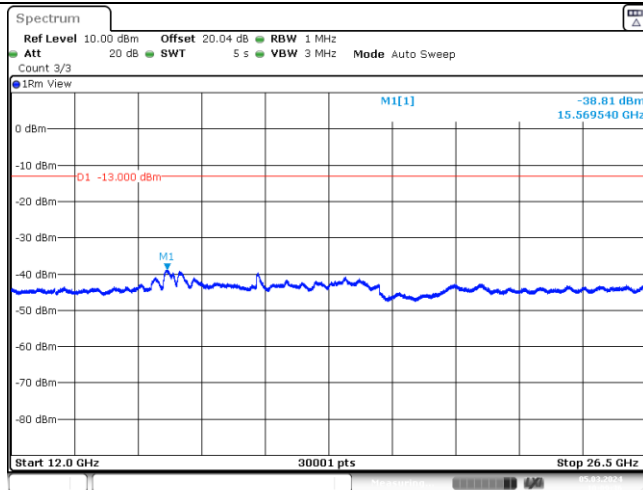

Date: 5.MAR.2024 10:09:36

Band25-5MHz-16QAM-26665-1-0-High-12000-26500--38.81-PASS

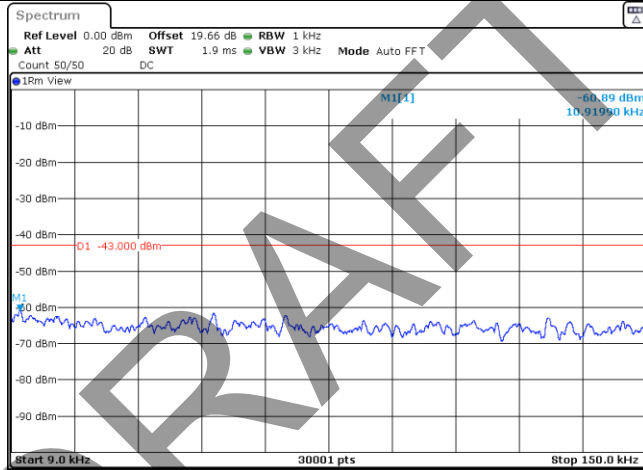

Date: 5.MAR.2024 10:25:56

Band25-10MHz-QPSK-26090-1-0-Low-0.009-0.15--60.89-PASS

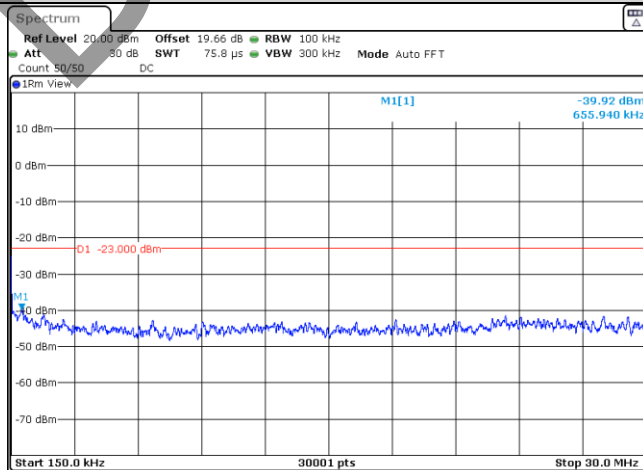

Date: 5.MAR.2024 10:26:01

Band25-10MHz-QPSK-26090-1-0-Low-0.15-30--39.92-PASS

BV 7Layers Communications Technology (Shenzhen) Co., Ltd

Room B37, Warehouse A5, No.3 Chiwan 4th Road, Zhaoshang Street, Nanshan District Shenzhen, Guangdong, People's Republic of China

Tel: +86 755 8869 6566 Fax: +86 755 8869 6577 Email: customerservice.sw@bureauveritas.com



BUREAU VERITAS

Test Report No.: W7L-P23120015R102

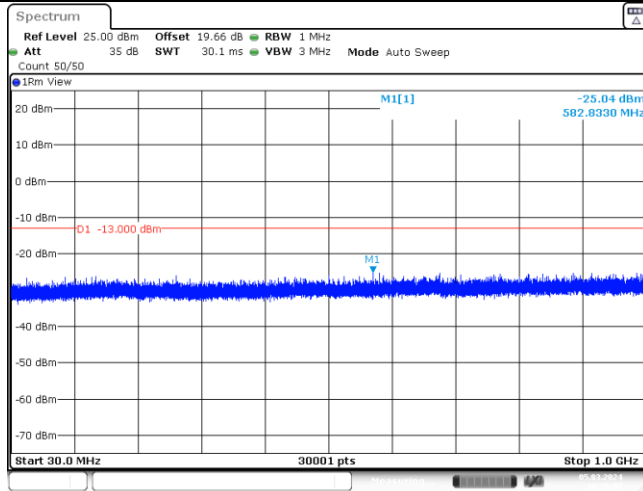

Band25-10MHz-QPSK-26090-1-0-Low-30-1000--25.04-PASS

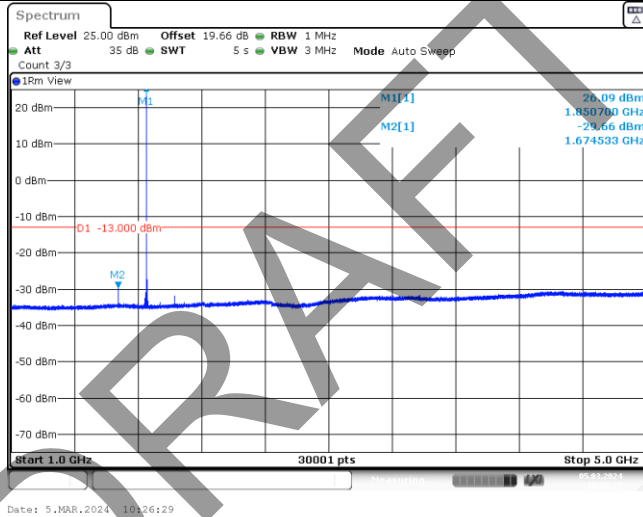

Band25-10MHz-QPSK-26090-1-0-Low-1000-5000--29.66-PASS

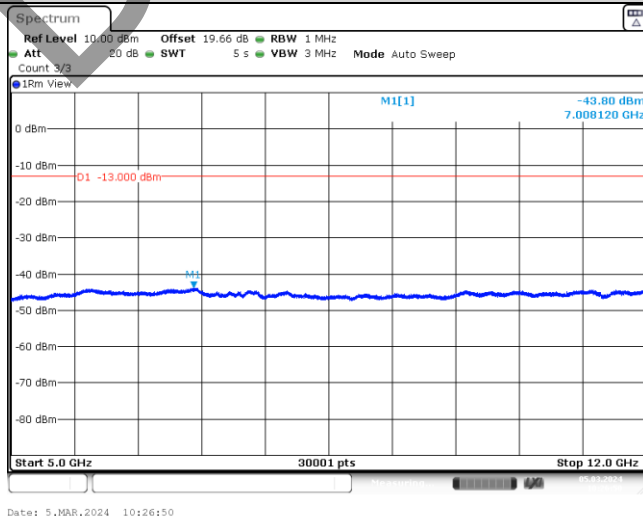

Band25-10MHz-QPSK-26090-1-0-Low-5000-12000--43.8-PASS



BUREAU VERITAS

Test Report No.: W7L-P23120015R102

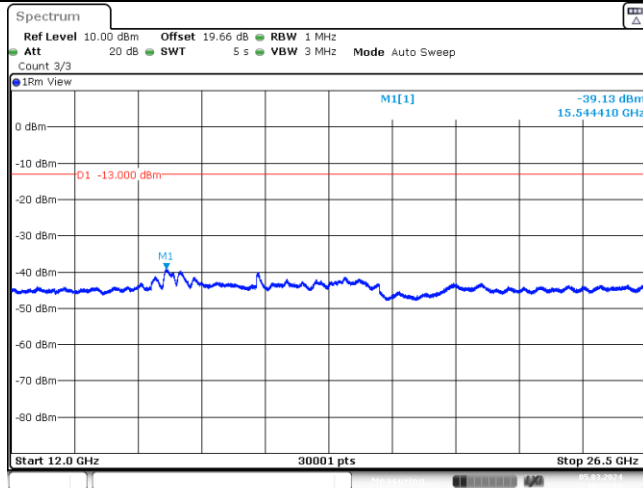

Date: 5.MAR.2024 10:27:11

Band25-10MHz-QPSK-26090-1-0-Low-12000-26500--39.13-PASS

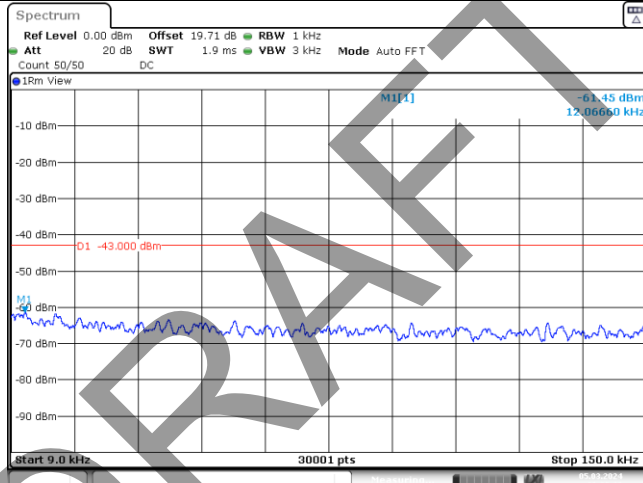

Date: 5.MAR.2024 10:28:39

Band25-10MHz-QPSK-26365-1-0-Low-0.009-0.15--61.45-PASS

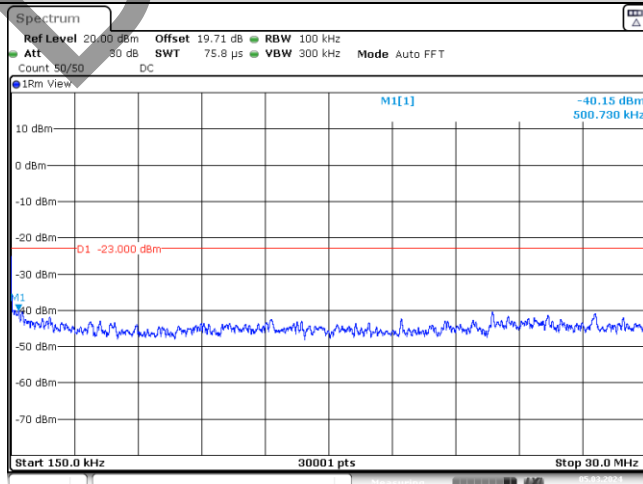

Date: 5.MAR.2024 10:28:43

Band25-10MHz-QPSK-26365-1-0-Low-0.15-30--40.15-PASS

BV 7Layers Communications Technology (Shenzhen) Co., Ltd

Room B37, Warehouse A5, No.3 Chiwan 4th Road, Zhaoshang Street, Nanshan District Shenzhen, Guangdong, People's Republic of China

Tel: +86 755 8869 6566 Fax: +86 755 8869 6577

Email: customerservice.sw@bureauveritas.com



BUREAU VERITAS

Test Report No.: W7L-P23120015R102

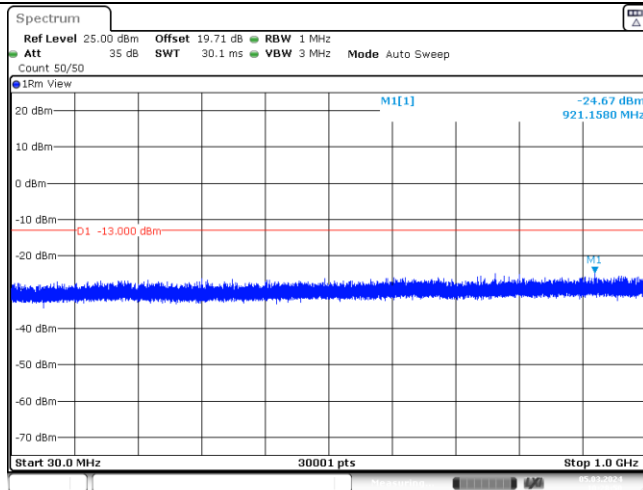

Date: 5.MAR.2024 10:28:50

Band25-10MHz-QPSK-26365-1-0-Low-30-1000--24.67-PASS

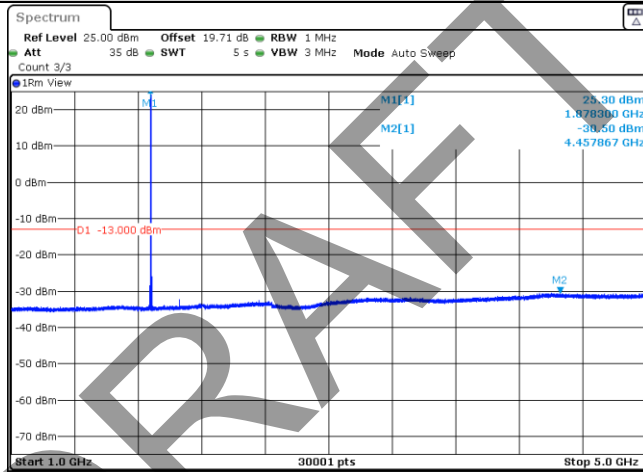

Date: 5.MAR.2024 10:29:12

Band25-10MHz-QPSK-26365-1-0-Low-1000-5000--30.5-PASS

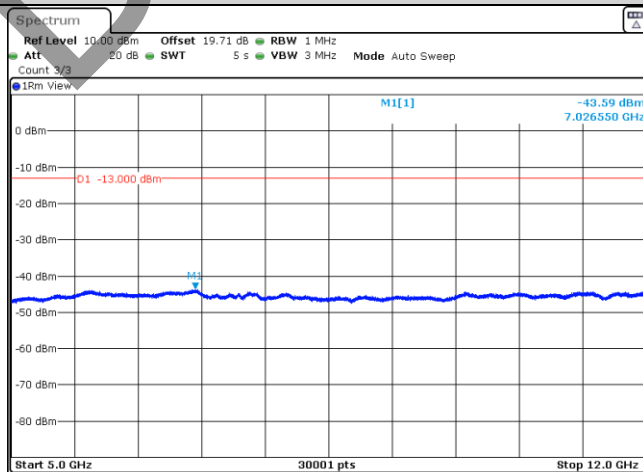

Date: 5.MAR.2024 10:29:33

Band25-10MHz-QPSK-26365-1-0-Low-5000-12000--43.59-PASS



BUREAU VERITAS

Test Report No.: W7L-P23120015R102

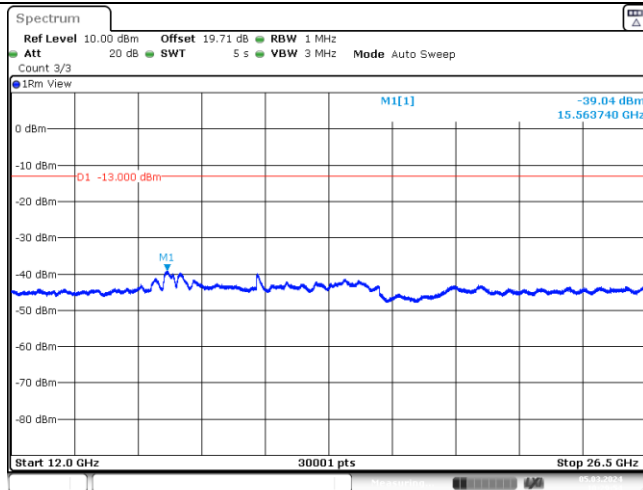

Date: 5.MAR.2024 10:29:54

Band25-10MHz-QPSK-26365-1-0-Low-12000-26500--39.04-PASS

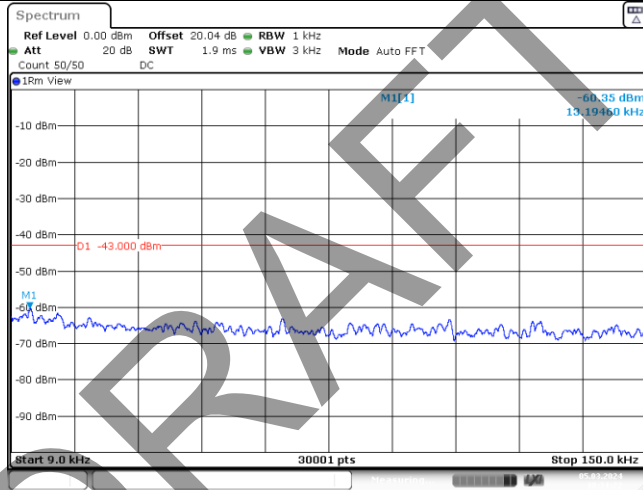

Date: 5.MAR.2024 10:31:22

Band25-10MHz-QPSK-26640-1-0-High-0.009-0.15--60.35-PASS

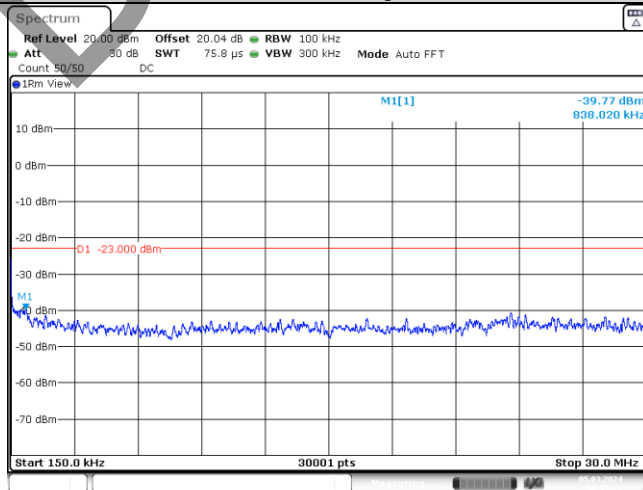

Date: 5.MAR.2024 10:31:27

Band25-10MHz-QPSK-26640-1-0-High-0.15-30--39.77-PASS

BV 7Layers Communications Technology (Shenzhen) Co., Ltd

Room B37, Warehouse A5, No.3 Chiwan 4th Road, Zhaoshang Street, Nanshan District Shenzhen, Guangdong, People's Republic of China

Tel: +86 755 8869 6566 Fax: +86 755 8869 6577

Email: customerservice.sw@bureauveritas.com



BUREAU VERITAS

Test Report No.: W7L-P23120015R102

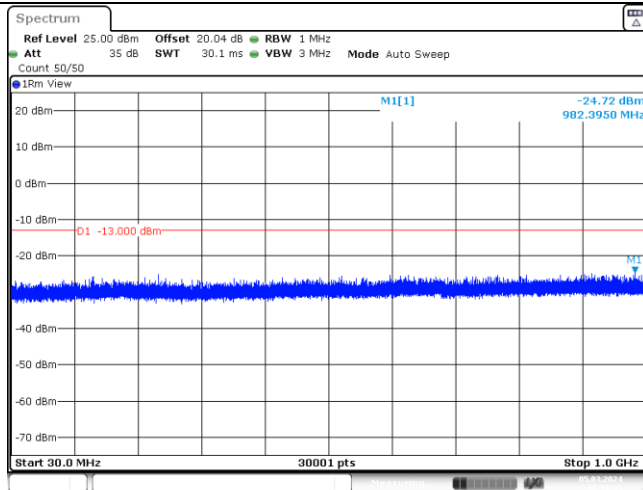

Date: 5.MAR.2024 10:31:33

Band25-10MHz-QPSK-26640-1-0-High-30-1000--24.72-PASS

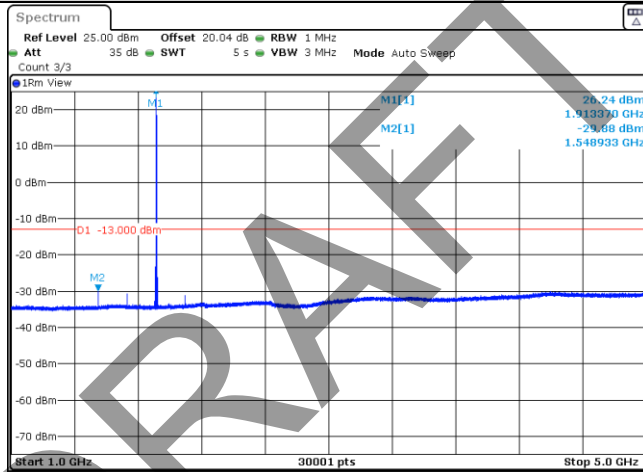

Date: 5.MAR.2024 10:31:55

Band25-10MHz-QPSK-26640-1-0-High-1000-5000--29.88-PASS

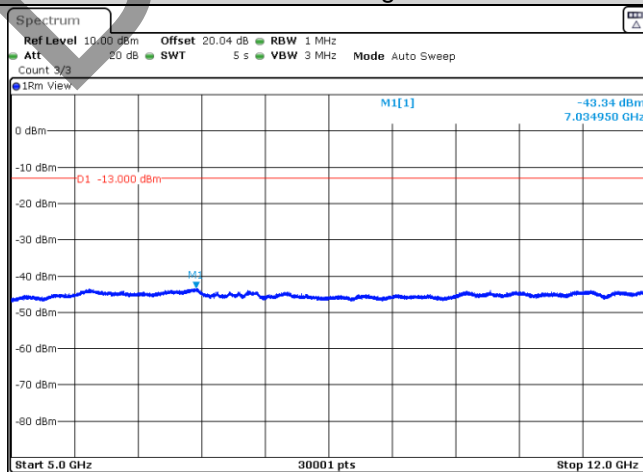

Date: 5.MAR.2024 10:32:16

Band25-10MHz-QPSK-26640-1-0-High-5000-12000--43.34-PASS

BV 7Layers Communications Technology (Shenzhen) Co., Ltd

Room B37, Warehouse A5, No.3 Chiwan 4th Road, Zhaoshang Street, Nanshan District Shenzhen, Guangdong, People's Republic of China

Tel: +86 755 8869 6566 Fax: +86 755 8869 6577

Email: customerservice.sw@bureauveritas.com



BUREAU VERITAS

Test Report No.: W7L-P23120015R102

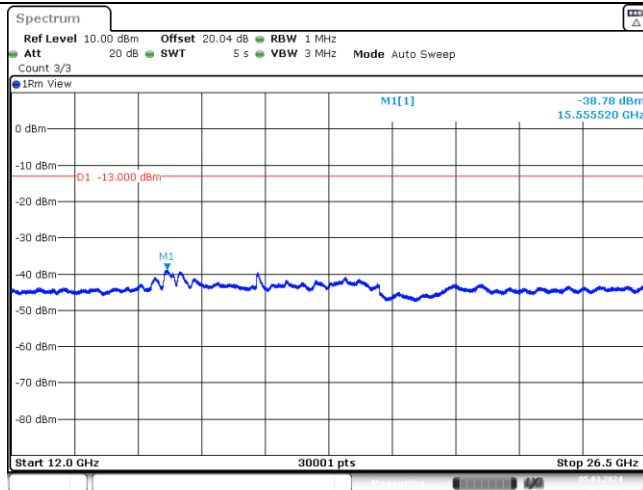

Date: 5.MAR.2024 10:32:37

Band25-10MHz-QPSK-26640-1-0-High-12000-26500--38.78-PASS

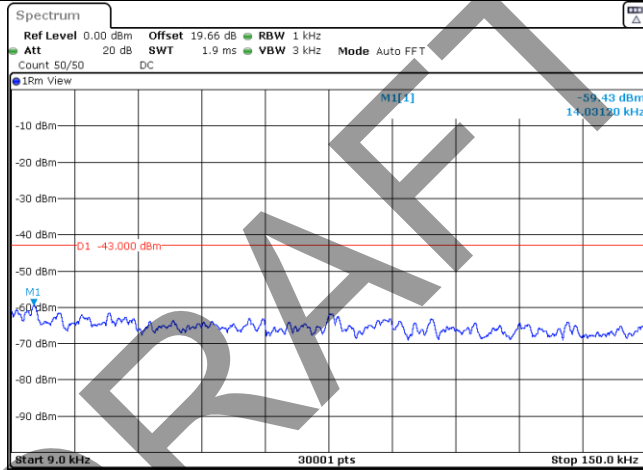

Date: 5.MAR.2024 10:27:17

Band25-10MHz-16QAM-26090-1-0-Low-0.009-0.15--59.43-PASS

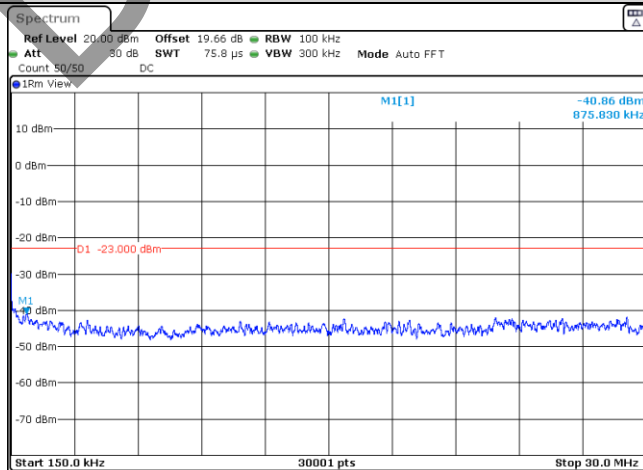

Date: 5.MAR.2024 10:27:21

Band25-10MHz-16QAM-26090-1-0-Low-0.15-30--40.86-PASS

BV 7Layers Communications Technology (Shenzhen) Co., Ltd

Room B37, Warehouse A5, No.3 Chiwan 4th Road, Zhaoshang Street, Nanshan District Shenzhen, Guangdong, People's Republic of China

Tel: +86 755 8869 6566 Fax: +86 755 8869 6577 Email: customerservice.sw@bureauveritas.com



BUREAU VERITAS

Test Report No.: W7L-P23120015R102

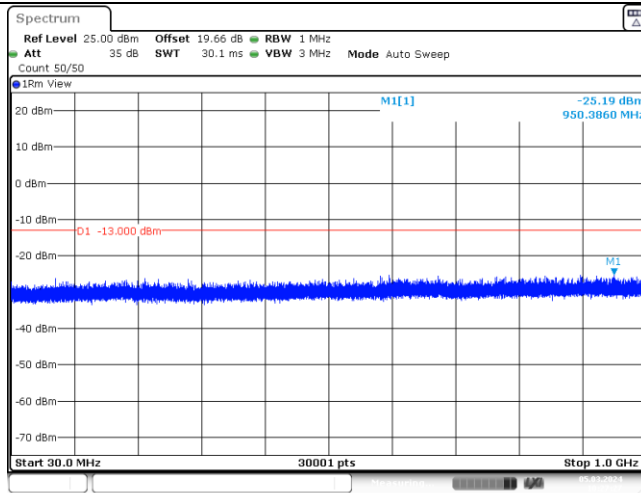

Date: 5.MAR.2024 10:27:28

Band25-10MHz-16QAM-26090-1-0-Low-30-1000--25.19-PASS

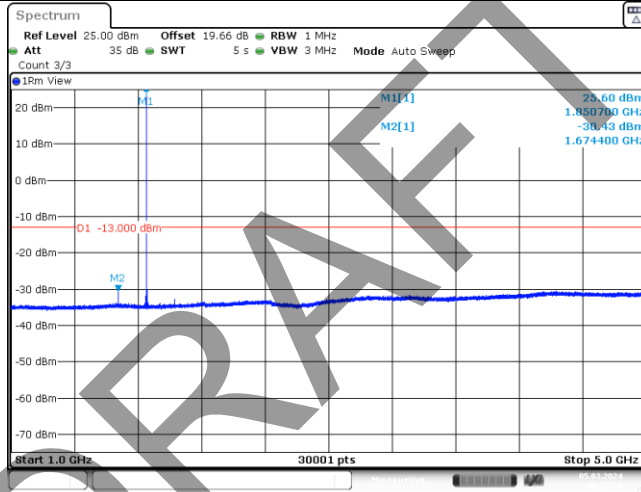

Date: 5.MAR.2024 10:27:50

Band25-10MHz-16QAM-26090-1-0-Low-1000-5000--30.43-PASS

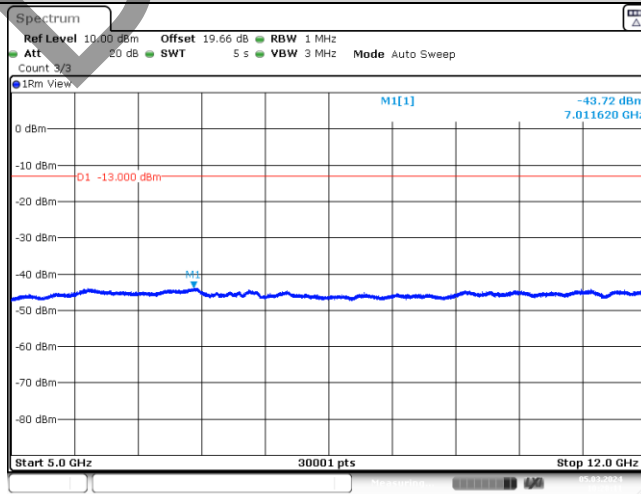

Date: 5.MAR.2024 10:28:11

Band25-10MHz-16QAM-26090-1-0-Low-5000-12000--43.72-PASS

BV 7Layers Communications Technology (Shenzhen) Co., Ltd

Room B37, Warehouse A5, No.3 Chiwan 4th Road, Zhaoshang Street, Nanshan District Shenzhen, Guangdong, People's Republic of China

Tel: +86 755 8869 6566
 Fax: +86 755 8869 6577
 Email: customerservice.sw@bureauveritas.com



BUREAU VERITAS

Test Report No.: W7L-P23120015R102

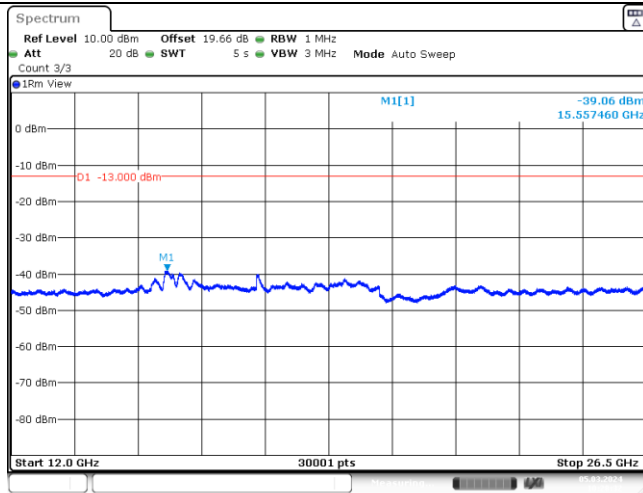

Date: 5.MAR.2024 10:28:32

Band25-10MHz-16QAM-26090-1-0-Low-12000-26500--39.06-PASS

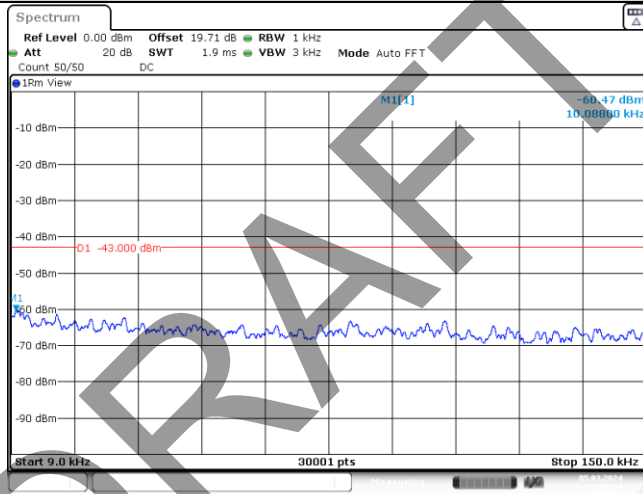

Date: 5.MAR.2024 10:29:59

Band25-10MHz-16QAM-26365-1-0-Low-0.009-0.15--60.47-PASS

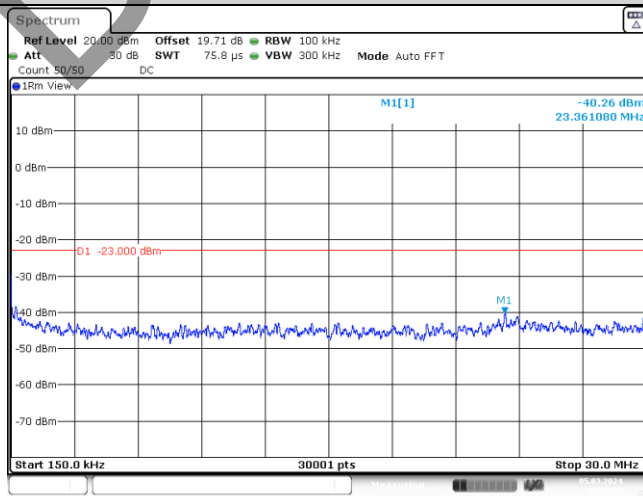

Date: 5.MAR.2024 10:30:04

Band25-10MHz-16QAM-26365-1-0-Low-0.15-30--40.26-PASS



BUREAU VERITAS

Test Report No.: W7L-P23120015R102

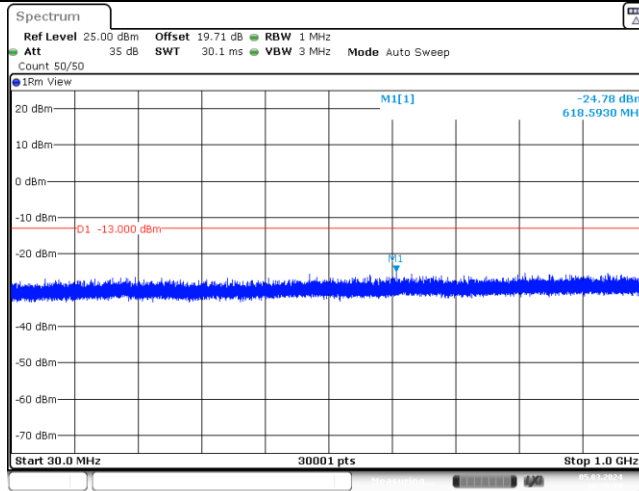

Band25-10MHz-16QAM-26365-1-0-Low-30-1000--24.78-PASS

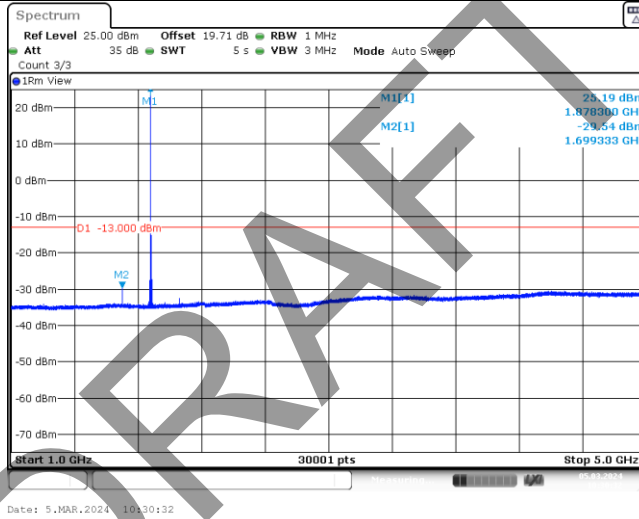

Band25-10MHz-16QAM-26365-1-0-Low-1000-5000--29.54-PASS

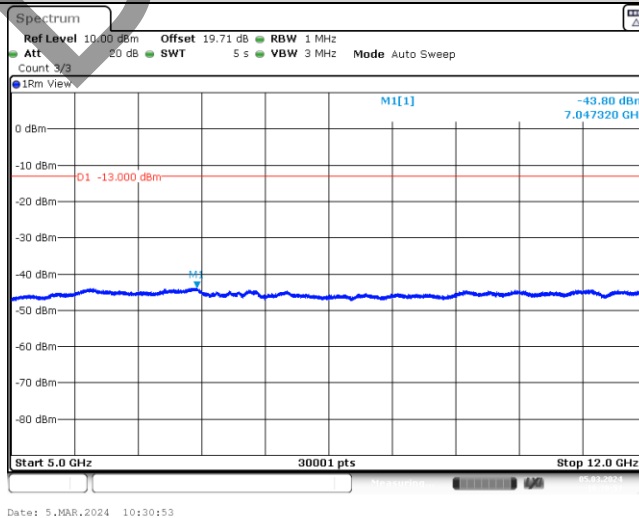

Band25-10MHz-16QAM-26365-1-0-Low-5000-12000--43.8-PASS

BV 7Layers Communications Technology (Shenzhen) Co., Ltd

Room B37, Warehouse A5, No.3 Chiwan 4th Road, Zhaoshang Street, Nanshan District Shenzhen, Guangdong, People's Republic of China

Tel: +86 755 8869 6566 Fax: +86 755 8869 6577

Email: customerservice.sw@bureauveritas.com



BUREAU VERITAS

Test Report No.: W7L-P23120015R102

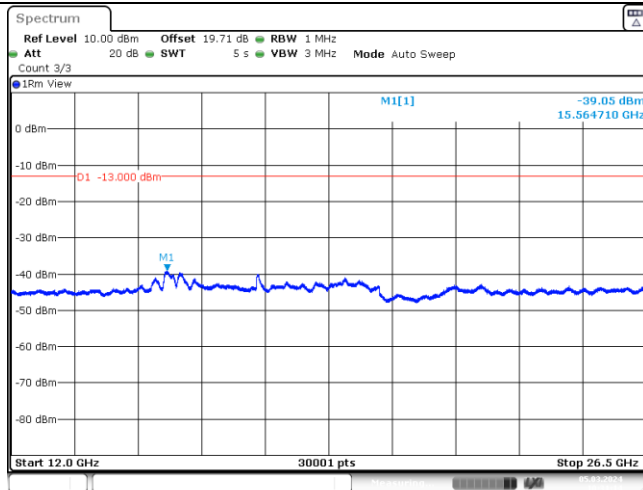

Date: 5.MAR.2024 10:31:14

Band25-10MHz-16QAM-26365-1-0-Low-12000-26500--39.05-PASS

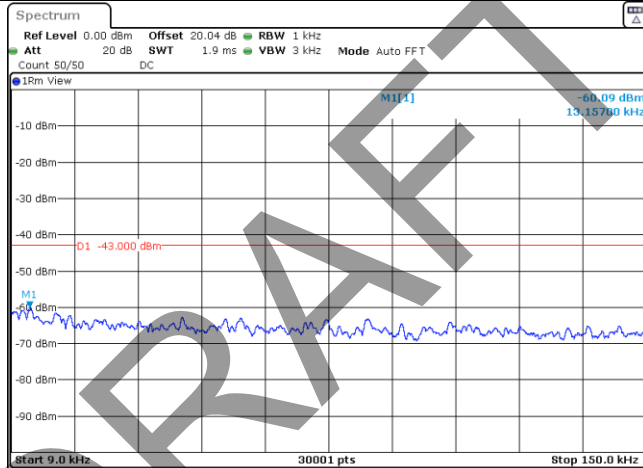

Date: 5.MAR.2024 10:32:43

Band25-10MHz-16QAM-26640-1-0-High-0.009-0.15--60.09-PASS

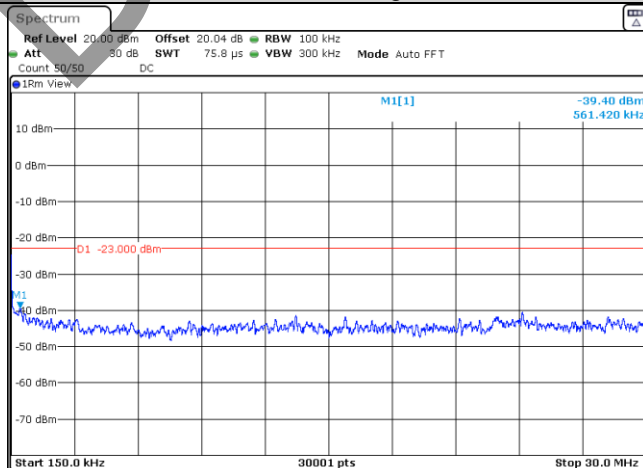

Date: 5.MAR.2024 10:32:47

Band25-10MHz-16QAM-26640-1-0-High-0.15-30--39.4-PASS

BV 7Layers Communications Technology (Shenzhen) Co., Ltd

Room B37, Warehouse A5, No.3 Chiwan 4th Road, Zhaoshang Street, Nanshan District Shenzhen, Guangdong, People's Republic of China

Tel: +86 755 8869 6566 Fax: +86 755 8869 6577

Email: customerservice.sw@bureauveritas.com



BUREAU VERITAS

Test Report No.: W7L-P23120015R102

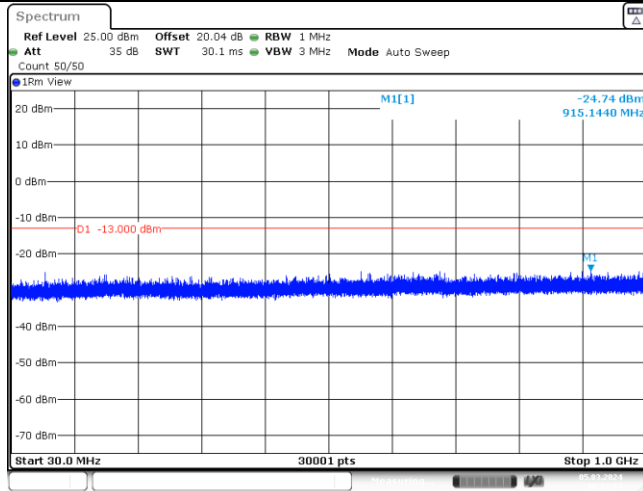

Band25-10MHz-16QAM-26640-1-0-High-30-1000--24.74-PASS

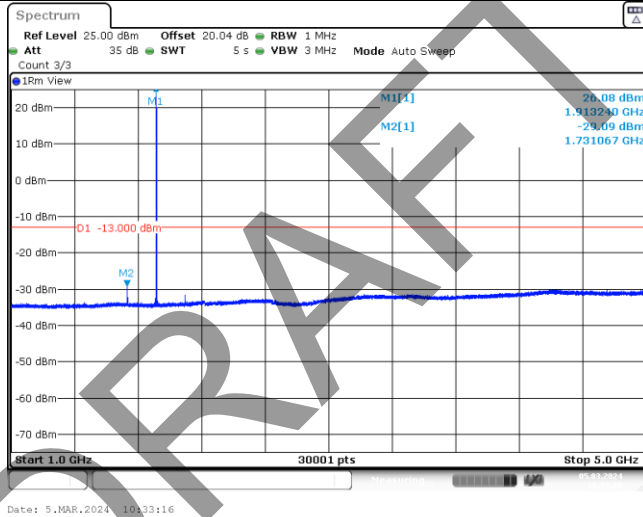

Band25-10MHz-16QAM-26640-1-0-High-1000-5000--29.09-PASS

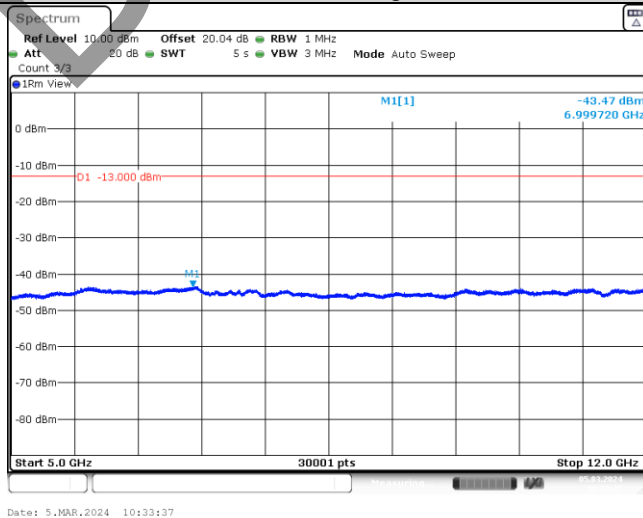

Band25-10MHz-16QAM-26640-1-0-High-5000-12000--43.47-PASS

BV 7Layers Communications Technology (Shenzhen) Co., Ltd

Room B37, Warehouse A5, No.3 Chiwan 4th Road, Zhaoshang Street, Nanshan District Shenzhen, Guangdong, People's Republic of China

Tel: +86 755 8869 6566 Fax: +86 755 8869 6577

Email: customerservice.sw@bureauveritas.com



BUREAU VERITAS

Test Report No.: W7L-P23120015R102

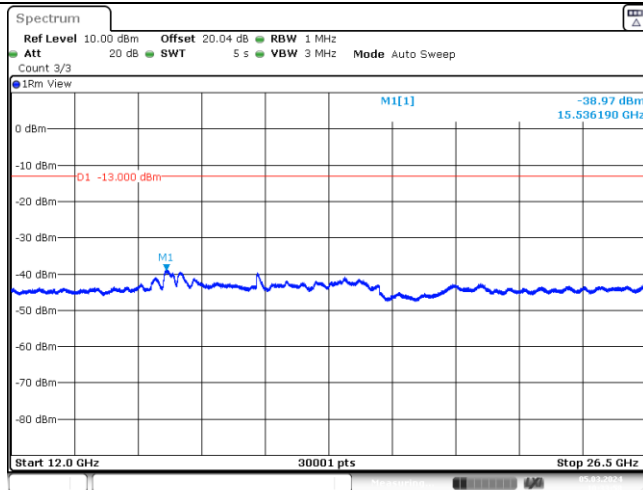

Date: 5.MAR.2024 10:33:58

Band25-10MHz-16QAM-26640-1-0-High-12000-26500--38.97-PASS

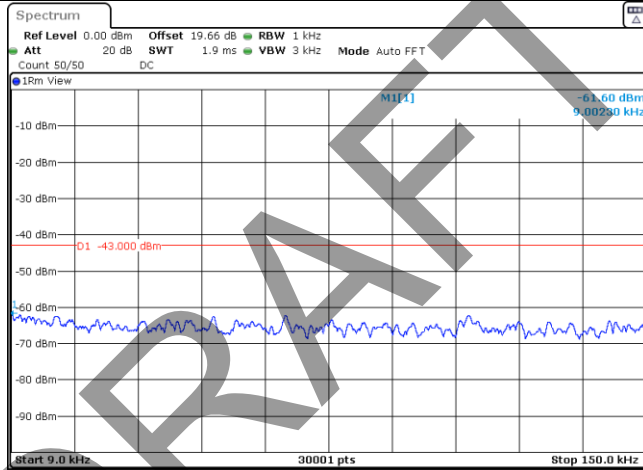

Date: 5.MAR.2024 10:50:06

Band25-15MHz-QPSK-26115-1-0-Low-0.009-0.15--61.6-PASS

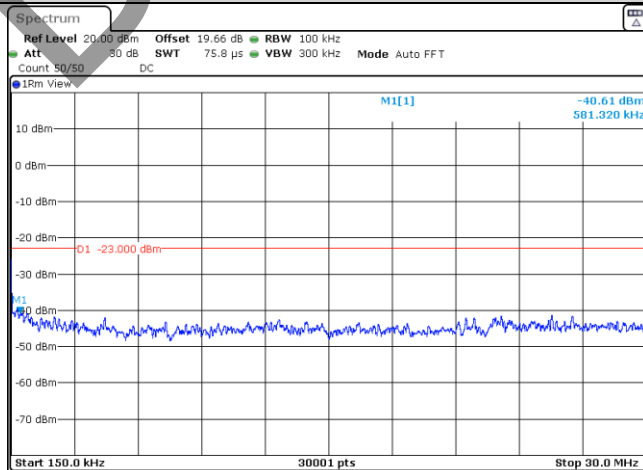

Date: 5.MAR.2024 10:50:11

Band25-15MHz-QPSK-26115-1-0-Low-0.15-30--40.61-PASS

BV 7Layers Communications Technology (Shenzhen) Co., Ltd

Room B37, Warehouse A5, No.3 Chiwan 4th Road, Zhaoshang Street, Nanshan District Shenzhen, Guangdong, People's Republic of China

Tel: +86 755 8869 6566 Fax: +86 755 8869 6577 Email: customerservice.sw@bureauveritas.com



BUREAU VERITAS

Test Report No.: W7L-P23120015R102

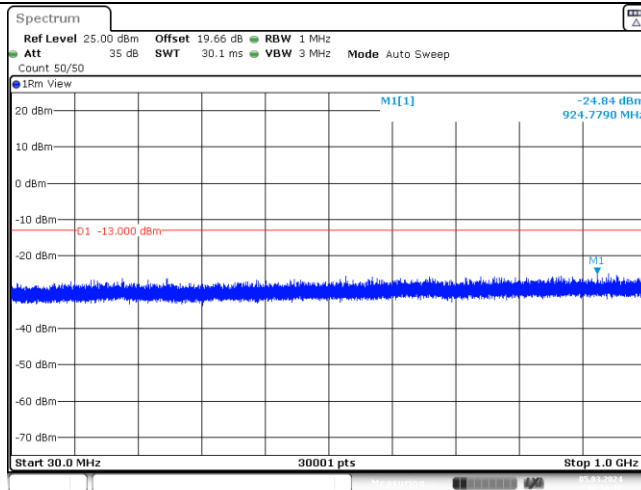

Date: 5.MAR.2024 10:50:18

Band25-15MHz-QPSK-26115-1-0-Low-30-1000--24.84-PASS

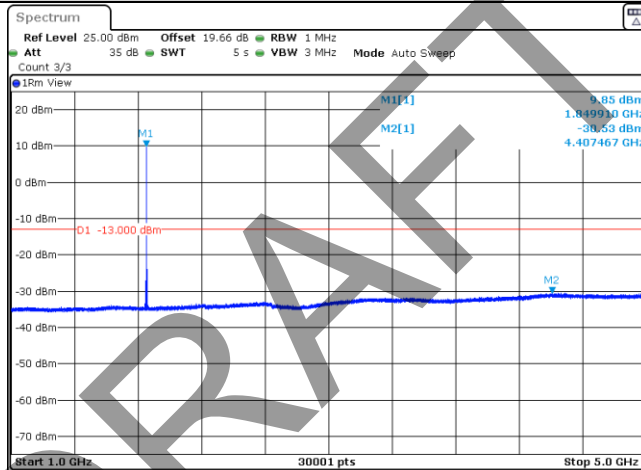

Date: 5.MAR.2024 10:50:40

Band25-15MHz-QPSK-26115-1-0-Low-1000-5000--30.53-PASS

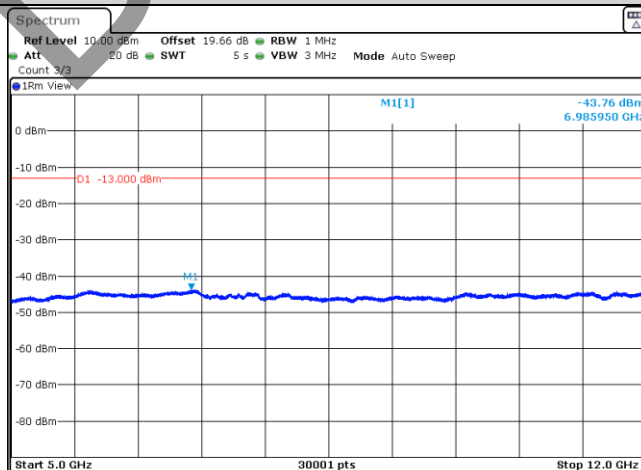

Date: 5.MAR.2024 10:51:01

Band25-15MHz-QPSK-26115-1-0-Low-5000-12000--43.76-PASS

BV 7Layers Communications Technology (Shenzhen) Co., Ltd

Room B37, Warehouse A5, No.3 Chiwan 4th Road, Zhaoshang Street, Nanshan District Shenzhen, Guangdong, People's Republic of China

Tel: +86 755 8869 6566 Fax: +86 755 8869 6577

Email: customerservice.sw@bureauveritas.com



BUREAU VERITAS

Test Report No.: W7L-P23120015R102

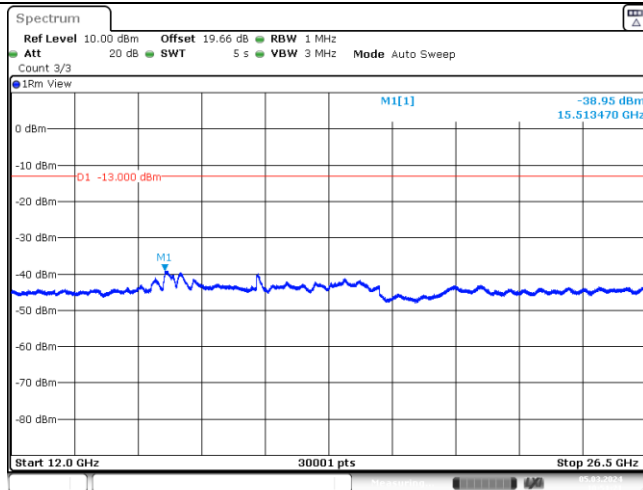

Date: 5.MAR.2024 10:51:22

Band25-15MHz-QPSK-26115-1-0-Low-12000-26500--38.95-PASS

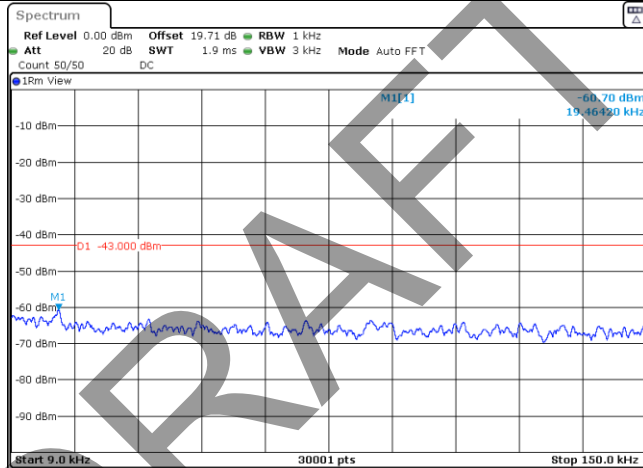

Date: 5.MAR.2024 10:52:49

Band25-15MHz-QPSK-26365-1-0-Low-0.009-0.15--60.7-PASS

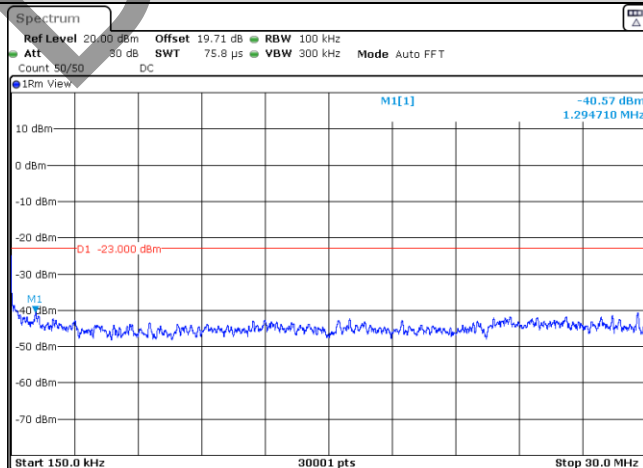

Date: 5.MAR.2024 10:52:53

Band25-15MHz-QPSK-26365-1-0-Low-0.15-30--40.57-PASS

BV 7Layers Communications Technology (Shenzhen) Co., Ltd

Room B37, Warehouse A5, No.3 Chiwan 4th Road, Zhaoshang Street, Nanshan District Shenzhen, Guangdong, People's Republic of China

Tel: +86 755 8869 6566 Fax: +86 755 8869 6577

Email: customerservice.sw@bureauveritas.com



BUREAU VERITAS

Test Report No.: W7L-P23120015R102

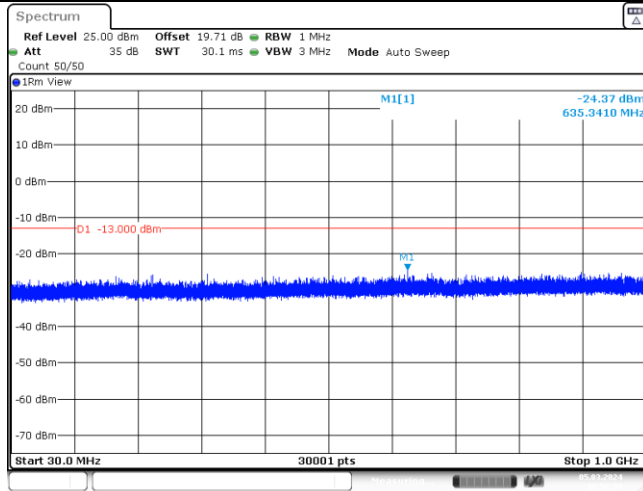

Band25-15MHz-QPSK-26365-1-0-Low-30-1000--24.37-PASS



Band25-15MHz-QPSK-26365-1-0-Low-1000-5000--30.47-PASS

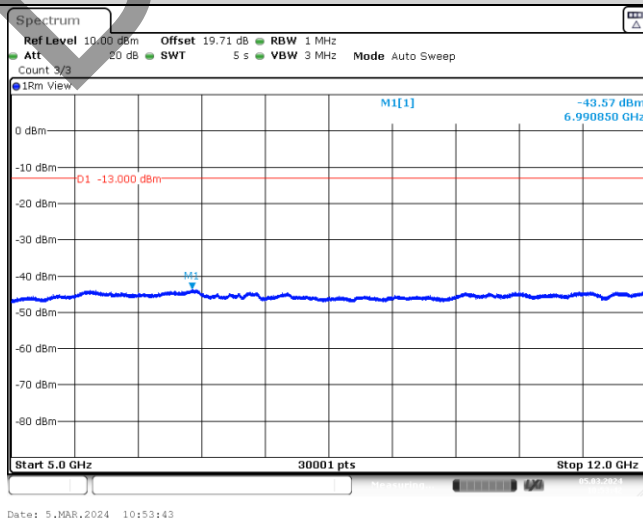

Band25-15MHz-QPSK-26365-1-0-Low-5000-12000--43.57-PASS

BV 7Layers Communications Technology (Shenzhen) Co., Ltd

Room B37, Warehouse A5, No.3 Chiwan 4th Road, Zhaoshang Street, Nanshan District Shenzhen, Guangdong, People's Republic of China

Tel: +86 755 8869 6566 Fax: +86 755 8869 6577 Email: customerservice.sw@bureauveritas.com



BUREAU VERITAS

Test Report No.: W7L-P23120015R102

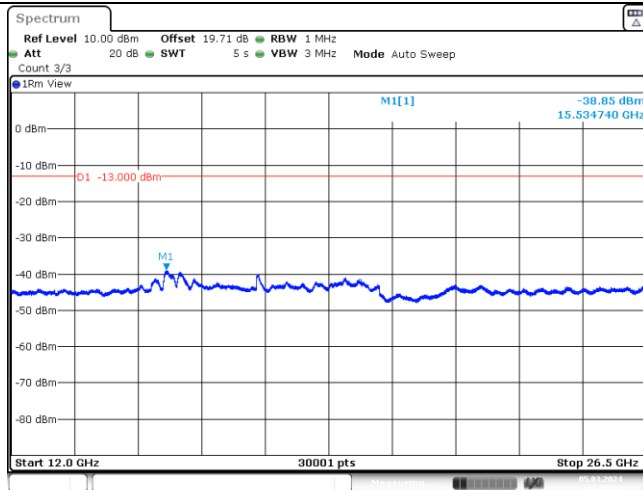

Date: 5.MAR.2024 10:54:04

Band25-15MHz-QPSK-26365-1-0-Low-12000-26500--38.85-PASS

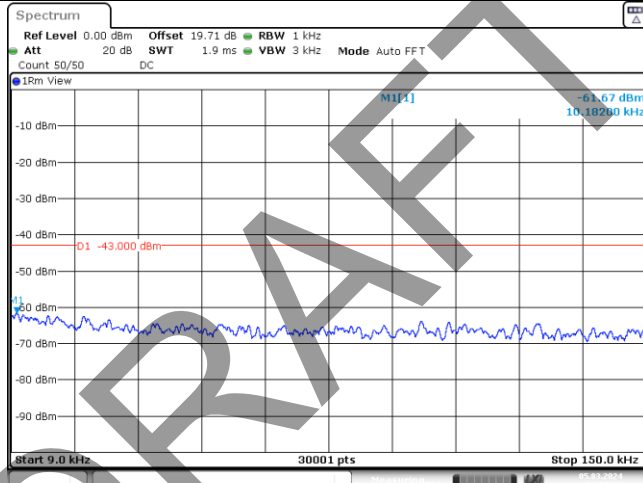

Date: 5.MAR.2024 10:55:31

Band25-15MHz-QPSK-26615-1-0-High-0.009-0.15--61.67-PASS

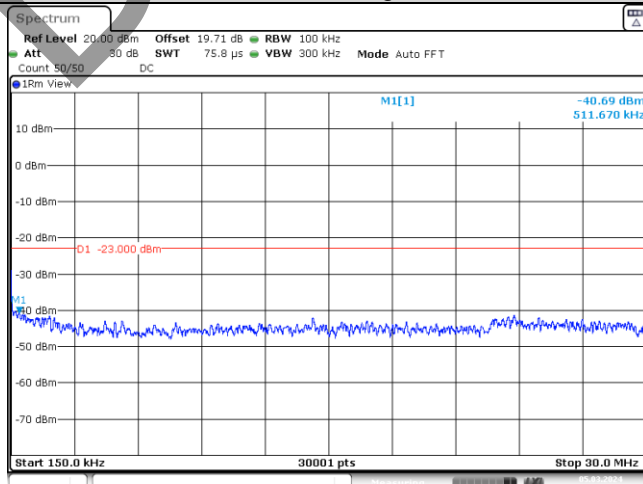

Date: 5.MAR.2024 10:55:36

Band25-15MHz-QPSK-26615-1-0-High-0.15-30--40.69-PASS

BV 7Layers Communications Technology (Shenzhen) Co., Ltd

Room B37, Warehouse A5, No.3 Chiwan 4th Road, Zhaoshang Street, Nanshan District Shenzhen, Guangdong, People's Republic of China

Tel: +86 755 8869 6566 Fax: +86 755 8869 6577

Email: customerservice.sw@bureauveritas.com



BUREAU VERITAS

Test Report No.: W7L-P23120015R102

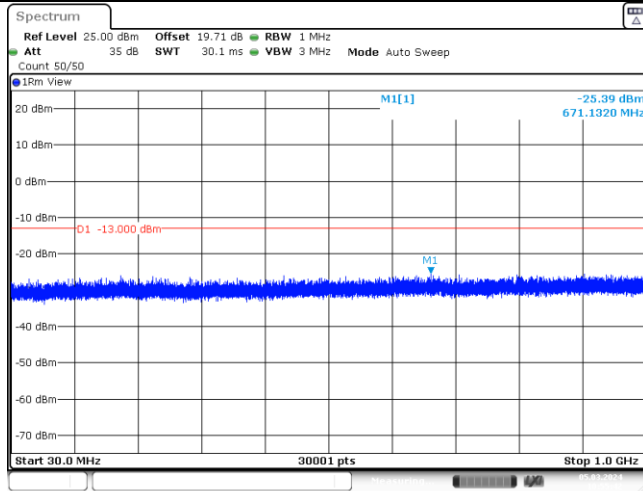

Band25-15MHz-QPSK-26615-1-0-High-30-1000--25.39-PASS

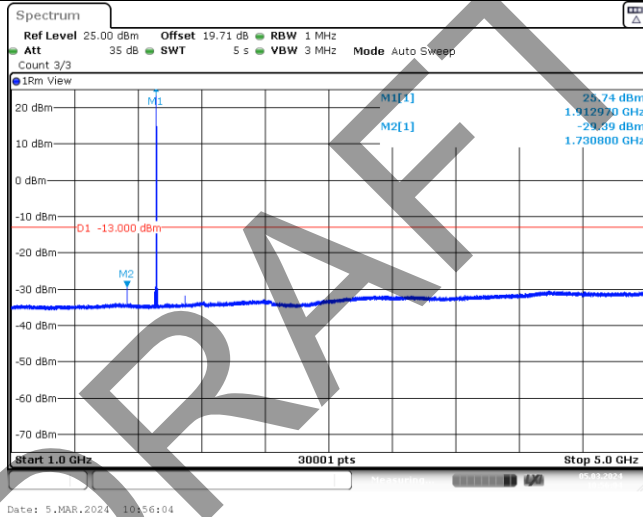

Band25-15MHz-QPSK-26615-1-0-High-1000-5000--29.39-PASS

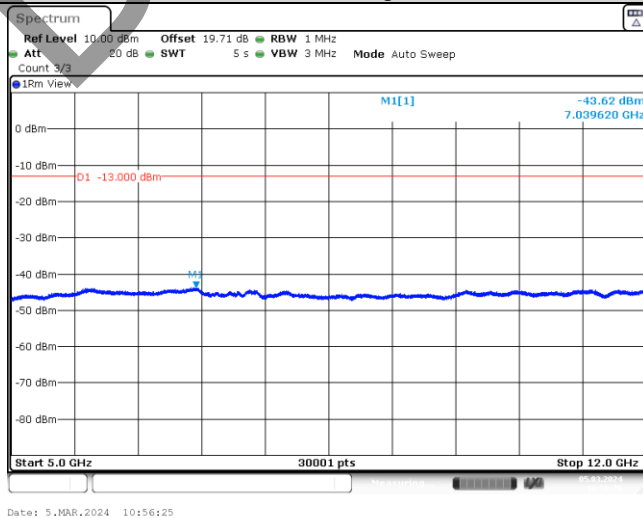

Band25-15MHz-QPSK-26615-1-0-High-5000-12000--43.62-PASS

BV 7Layers Communications Technology (Shenzhen) Co., Ltd

Room B37, Warehouse A5, No.3 Chiwan 4th Road, Zhaoshang Street, Nanshan District Shenzhen, Guangdong, People's Republic of China

Tel: +86 755 8869 6566
Fax: +86 755 8869 6577
Email: customerservice.sw@bureauveritas.com



BUREAU VERITAS

Test Report No.: W7L-P23120015R102

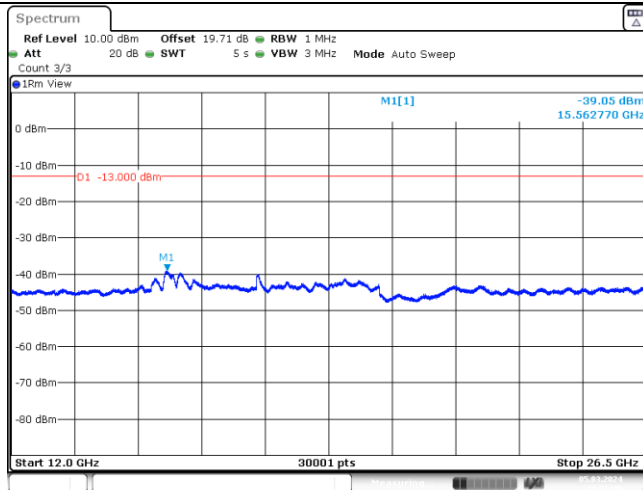

Date: 5.MAR.2024 10:56:46

Band25-15MHz-QPSK-26615-1-0-High-12000-26500--39.05-PASS

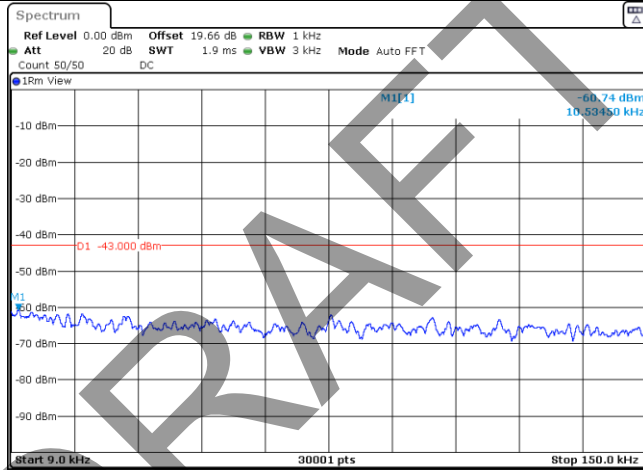

Date: 5.MAR.2024 10:51:27

Band25-15MHz-16QAM-26115-1-0-Low-0.009-0.15--60.74-PASS

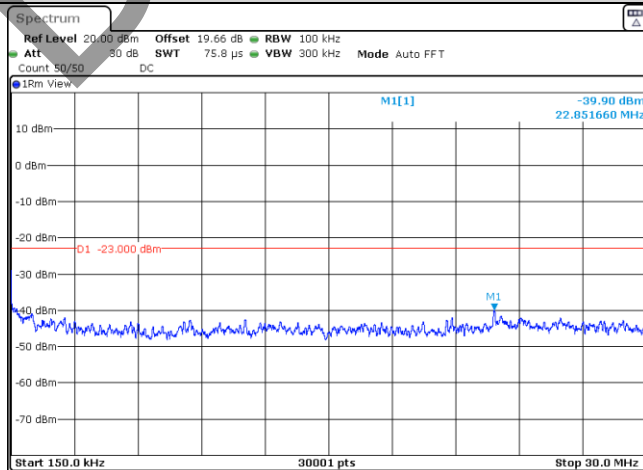

Date: 5.MAR.2024 10:51:31

Band25-15MHz-16QAM-26115-1-0-Low-0.15-30--39.9-PASS

BV 7Layers Communications Technology (Shenzhen) Co., Ltd

Room B37, Warehouse A5, No.3 Chiwan 4th Road, Zhaoshang Street, Nanshan District Shenzhen, Guangdong, People's Republic of China

Tel: +86 755 8869 6566
 Fax: +86 755 8869 6577
 Email: customerservice.sw@bureauveritas.com



BUREAU VERITAS

Test Report No.: W7L-P23120015R102

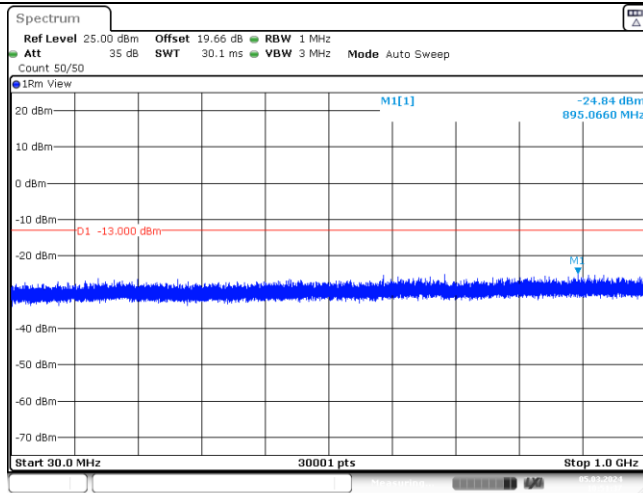

Band25-15MHz-16QAM-26115-1-0-Low-30-1000--24.84-PASS

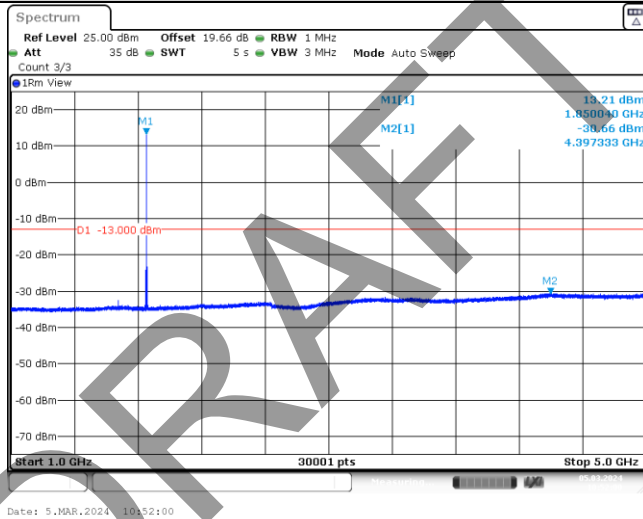

Band25-15MHz-16QAM-26115-1-0-Low-1000-5000--30.66-PASS

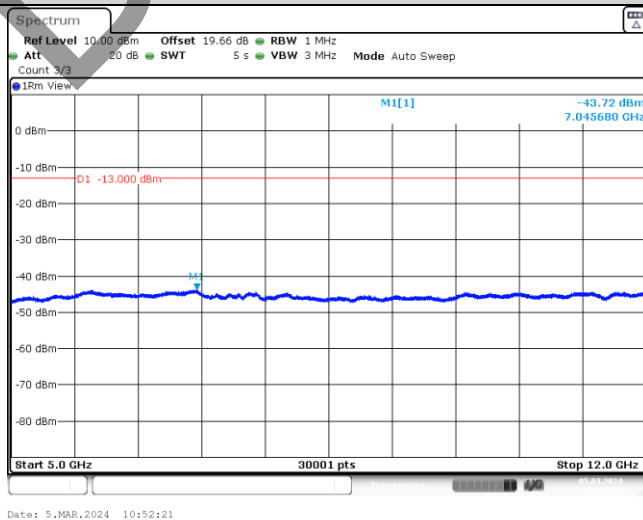

Band25-15MHz-16QAM-26115-1-0-Low-5000-12000--43.72-PASS

BV 7Layers Communications Technology (Shenzhen) Co., Ltd

Room B37, Warehouse A5, No.3 Chiwan 4th Road, Zhaoshang Street, Nanshan District Shenzhen, Guangdong, People's Republic of China

Tel: +86 755 8869 6566
Fax: +86 755 8869 6577
Email: customerservice.sw@bureauveritas.com



BUREAU VERITAS

Test Report No.: W7L-P23120015R102

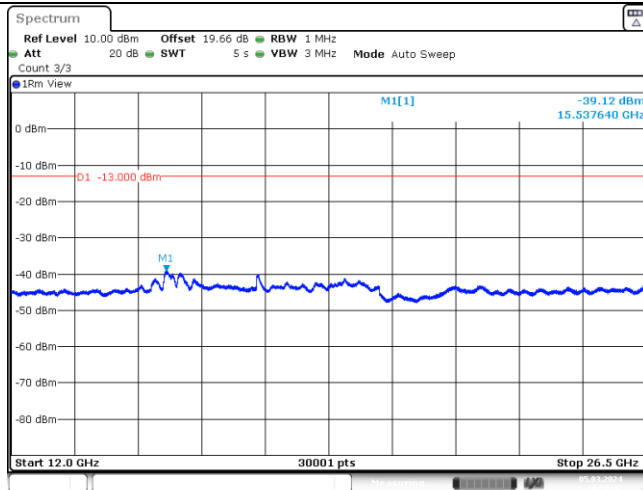

Date: 5.MAR.2024 10:52:42

Band25-15MHz-16QAM-26115-1-0-Low-12000-26500--39.12-PASS

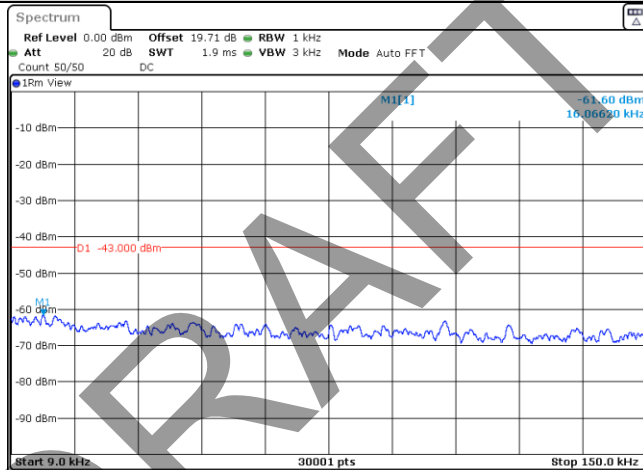

Date: 5.MAR.2024 10:54:09

Band25-15MHz-16QAM-26365-1-0-Low-0.009-0.15--61.6-PASS

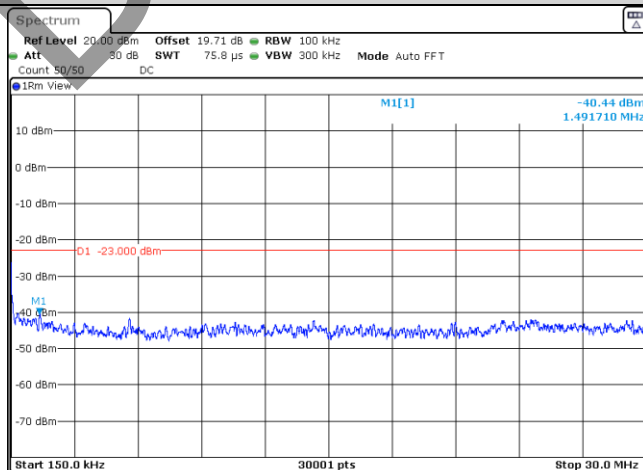

Date: 5.MAR.2024 10:54:14

Band25-15MHz-16QAM-26365-1-0-Low-0.15-30--40.44-PASS

BV 7Layers Communications Technology (Shenzhen) Co., Ltd

Room B37, Warehouse A5, No.3 Chiwan 4th Road, Zhaoshang Street, Nanshan District Shenzhen, Guangdong, People's Republic of China

Tel: +86 755 8869 6566 Fax: +86 755 8869 6577

Email: customerservice.sw@bureauveritas.com



BUREAU VERITAS

Test Report No.: W7L-P23120015R102

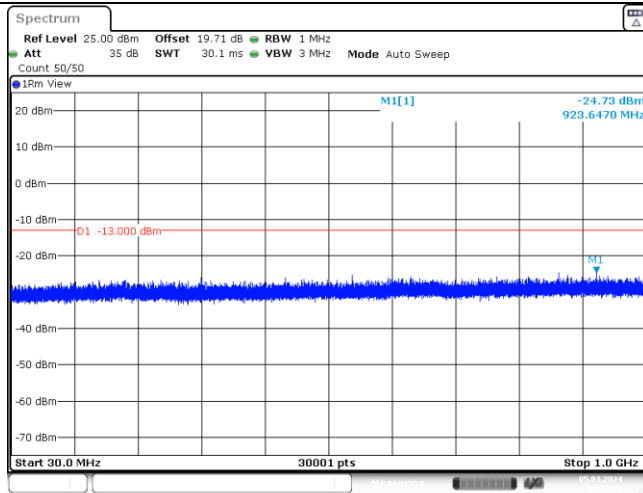

Band25-15MHz-16QAM-26365-1-0-Low-30-1000--24.73-PASS

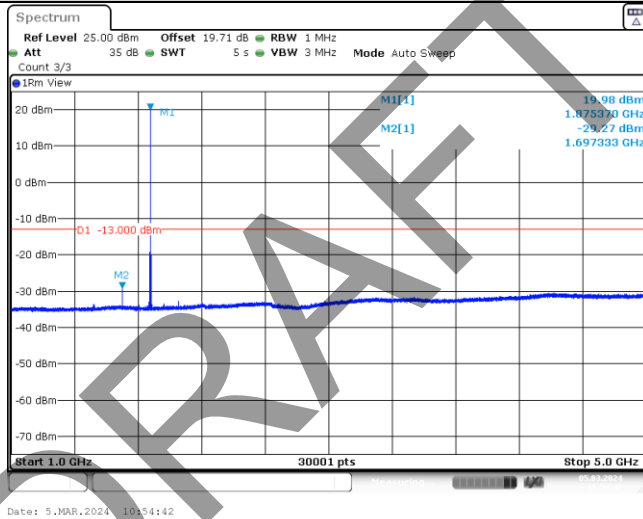

Band25-15MHz-16QAM-26365-1-0-Low-1000-5000--29.27-PASS

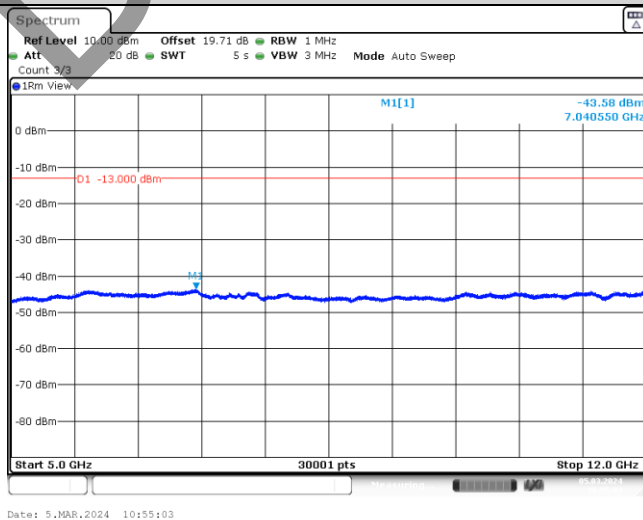

Band25-15MHz-16QAM-26365-1-0-Low-5000-12000--43.58-PASS

BV 7Layers Communications Technology (Shenzhen) Co., Ltd

Room B37, Warehouse A5, No.3 Chiwan 4th Road, Zhaoshang Street, Nanshan District Shenzhen, Guangdong, People's Republic of China

Tel: +86 755 8869 6566 Fax: +86 755 8869 6577

Email: customerservice.sw@bureauveritas.com



BUREAU VERITAS

Test Report No.: W7L-P23120015R102

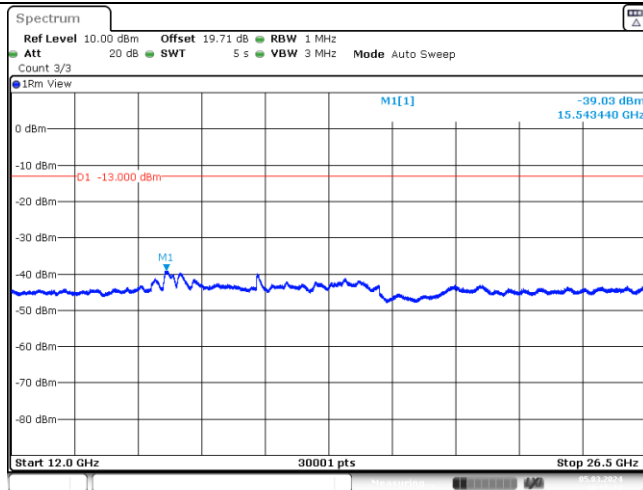

Date: 5.MAR.2024 10:55:24

Band25-15MHz-16QAM-26365-1-0-Low-12000-26500--39.03-PASS

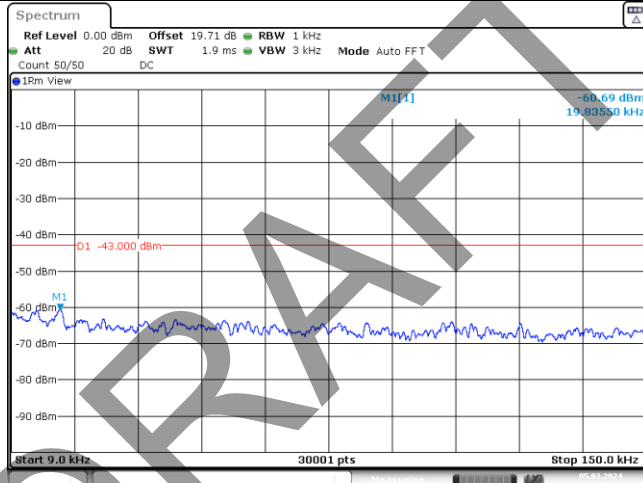

Date: 5.MAR.2024 10:56:51

Band25-15MHz-16QAM-26615-1-0-High-0.009-0.15--60.69-PASS

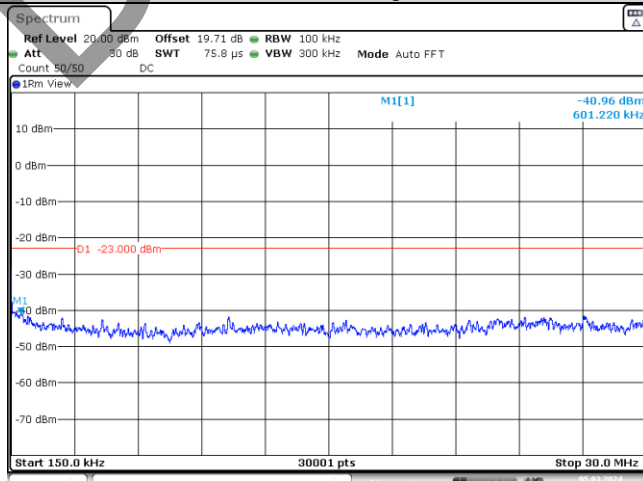

Date: 5.MAR.2024 10:56:56

Band25-15MHz-16QAM-26615-1-0-High-0.15-30--40.96-PASS

BV 7Layers Communications Technology (Shenzhen) Co., Ltd

Room B37, Warehouse A5, No.3 Chiwan 4th Road, Zhaoshang Street, Nanshan District Shenzhen, Guangdong, People's Republic of China

Tel: +86 755 8869 6566 Fax: +86 755 8869 6577

Email: customerservice.sw@bureauveritas.com



BUREAU VERITAS

Test Report No.: W7L-P23120015R102

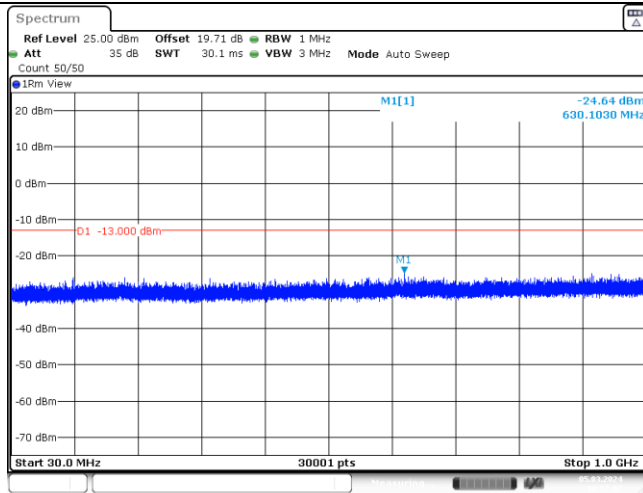

Band25-15MHz-16QAM-26615-1-0-High-30-1000--24.64-PASS

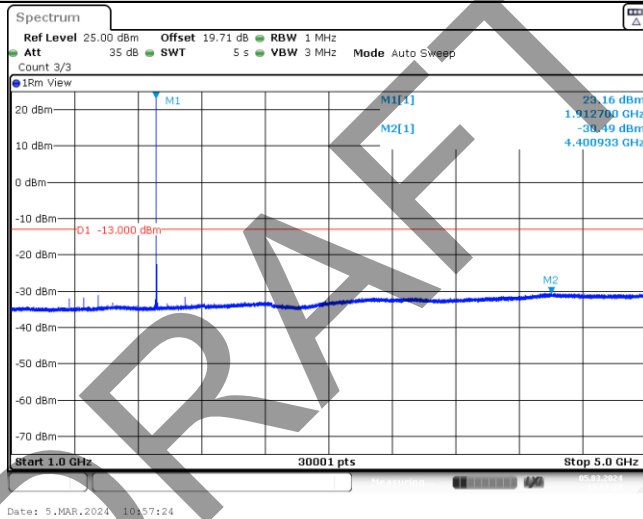

Band25-15MHz-16QAM-26615-1-0-High-1000-5000--30.49-PASS

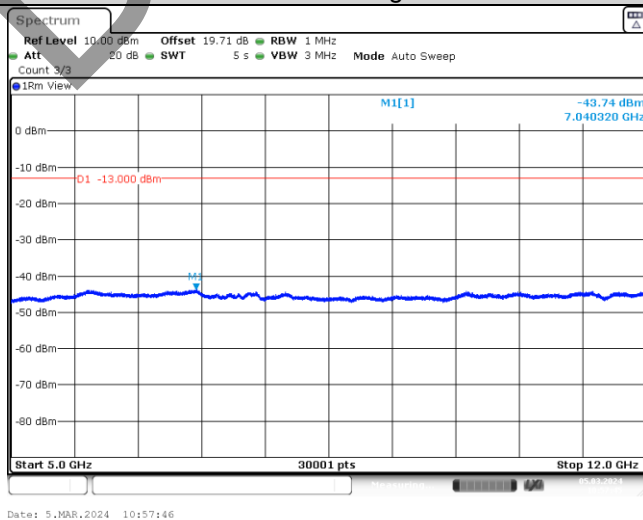

Band25-15MHz-16QAM-26615-1-0-High-5000-12000--43.74-PASS

BV 7Layers Communications Technology (Shenzhen) Co., Ltd

Room B37, Warehouse A5, No.3 Chiwan 4th Road, Zhaoshang Street, Nanshan District Shenzhen, Guangdong, People's Republic of China

Tel: +86 755 8869 6566 Fax: +86 755 8869 6577

Email: customerservice.sw@bureauveritas.com



BUREAU VERITAS

Test Report No.: W7L-P23120015R102

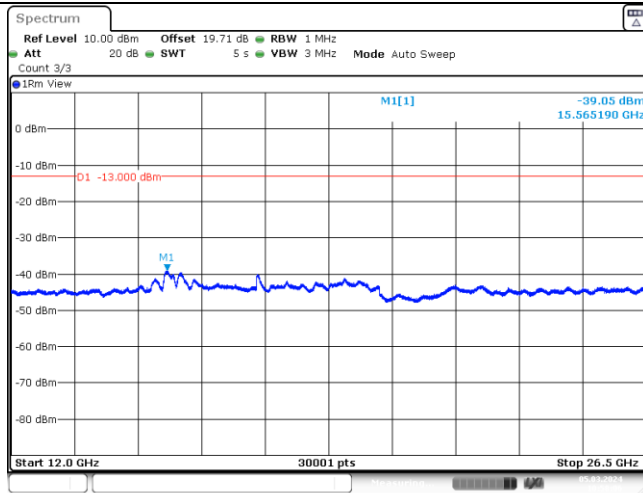

Band25-15MHz-16QAM-26615-1-0-High-12000-26500--39.05-PASS

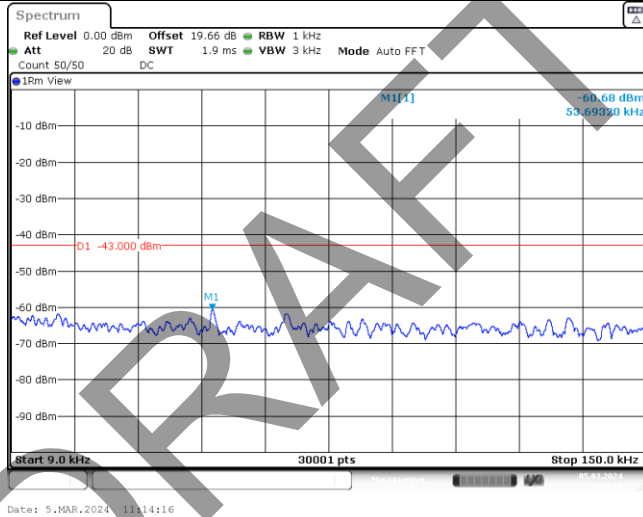

Band25-20MHz-QPSK-26140-1-0-Low-0.009-0.15--60.68-PASS

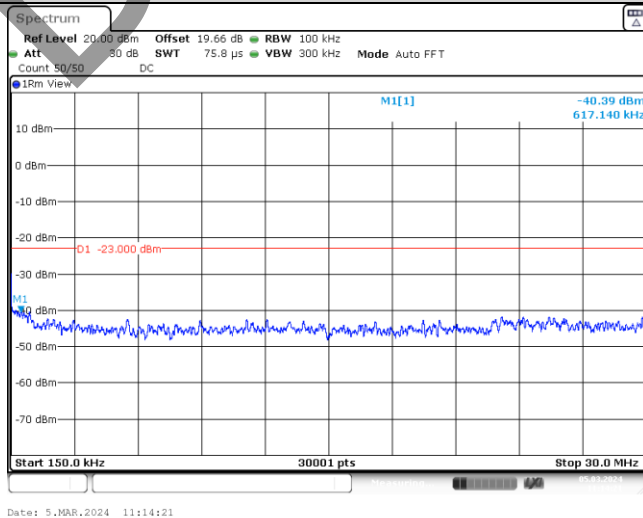

Band25-20MHz-QPSK-26140-1-0-Low-0.15-30--40.39-PASS

BV 7Layers Communications Technology (Shenzhen) Co., Ltd

Room B37, Warehouse A5, No.3 Chiwan 4th Road, Zhaoshang Street, Nanshan District Shenzhen, Guangdong, People's Republic of China

Tel: +86 755 8869 6566 Fax: +86 755 8869 6577 Email: customerservice.sw@bureauveritas.com



BUREAU VERITAS

Test Report No.: W7L-P23120015R102

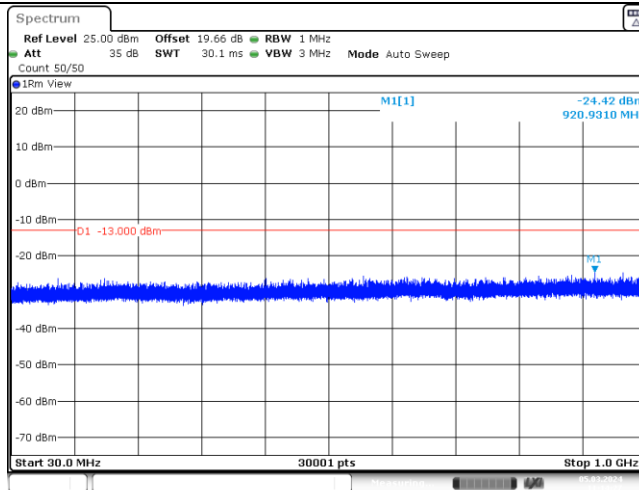

Date: 5.MAR.2024 11:14:27

Band25-20MHz-QPSK-26140-1-0-Low-30-1000--24.42-PASS

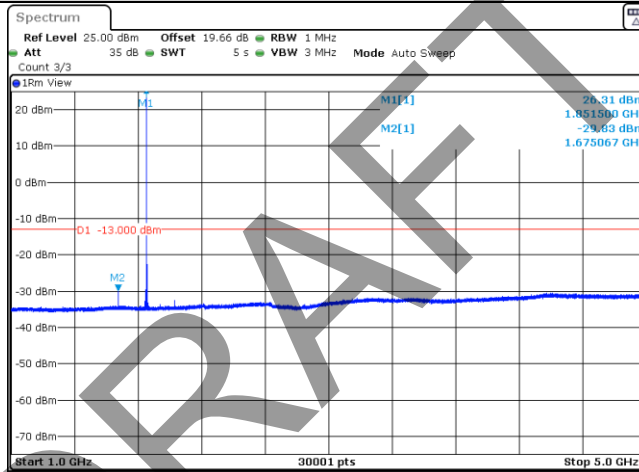

Date: 5.MAR.2024 11:14:50

Band25-20MHz-QPSK-26140-1-0-Low-1000-5000--29.83-PASS

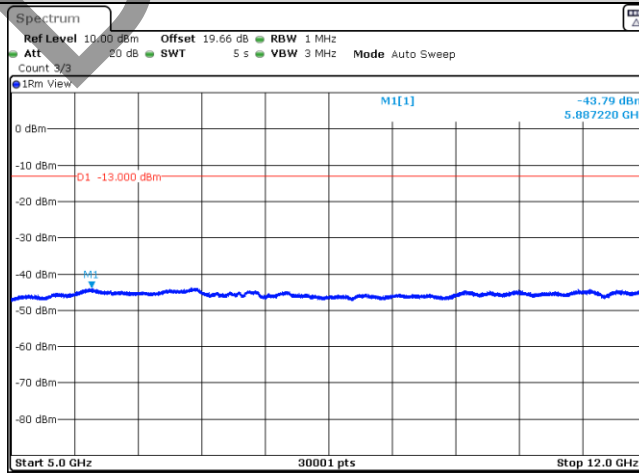

Date: 5.MAR.2024 11:15:11

Band25-20MHz-QPSK-26140-1-0-Low-5000-12000--43.79-PASS



BUREAU VERITAS

Test Report No.: W7L-P23120015R102

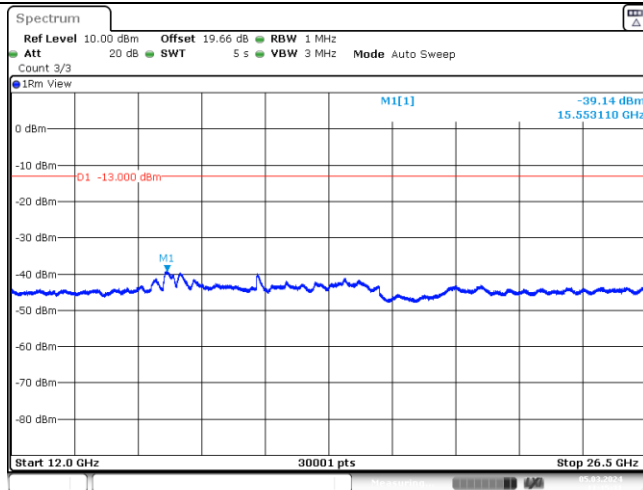

Date: 5.MAR.2024 11:15:32

Band25-20MHz-QPSK-26140-1-0-Low-12000-26500--39.14-PASS

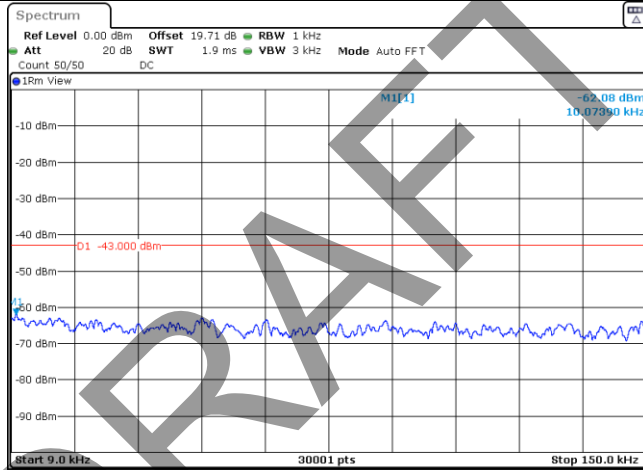

Date: 5.MAR.2024 11:16:59

Band25-20MHz-QPSK-26365-1-0-Low-0.009-0.15--62.08-PASS

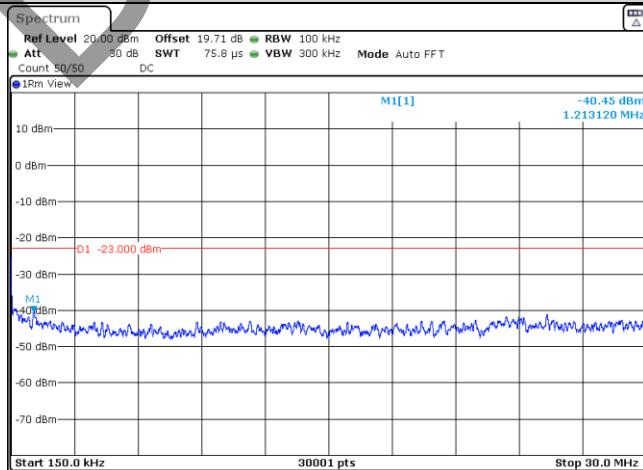

Date: 5.MAR.2024 11:17:03

Band25-20MHz-QPSK-26365-1-0-Low-0.15-30--40.45-PASS

BV 7Layers Communications Technology (Shenzhen) Co., Ltd

Room B37, Warehouse A5, No.3 Chiwan 4th Road, Zhaoshang Street, Nanshan District Shenzhen, Guangdong, People's Republic of China

Tel: +86 755 8869 6566 Fax: +86 755 8869 6577 Email: customerservice.sw@bureauveritas.com



BUREAU VERITAS

Test Report No.: W7L-P23120015R102

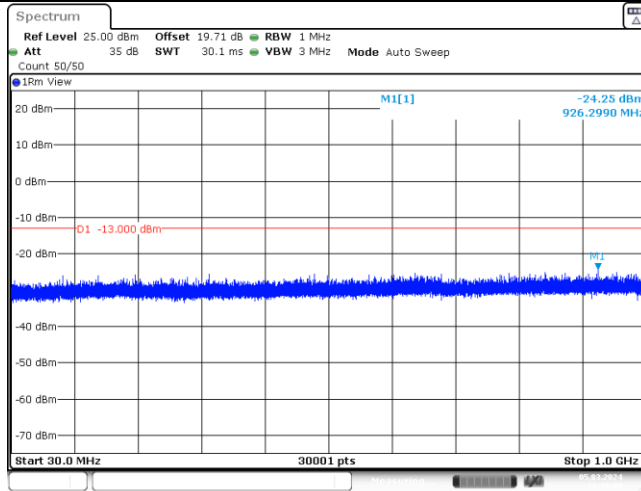

Date: 5.MAR.2024 11:17:10

Band25-20MHz-QPSK-26365-1-0-Low-30-1000--24.25-PASS

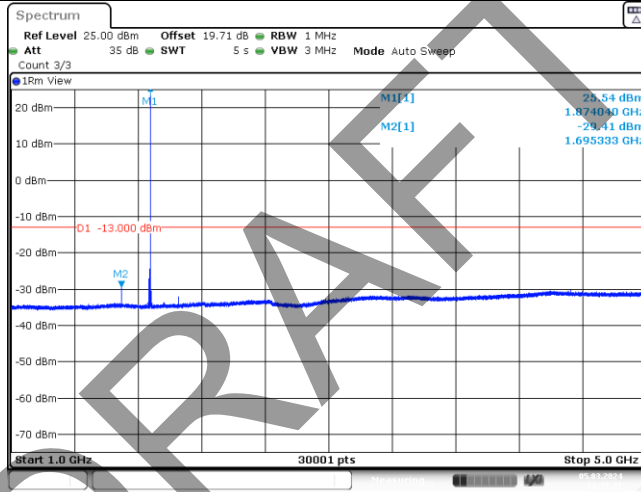

Date: 5.MAR.2024 11:17:32

Band25-20MHz-QPSK-26365-1-0-Low-1000-5000--29.41-PASS

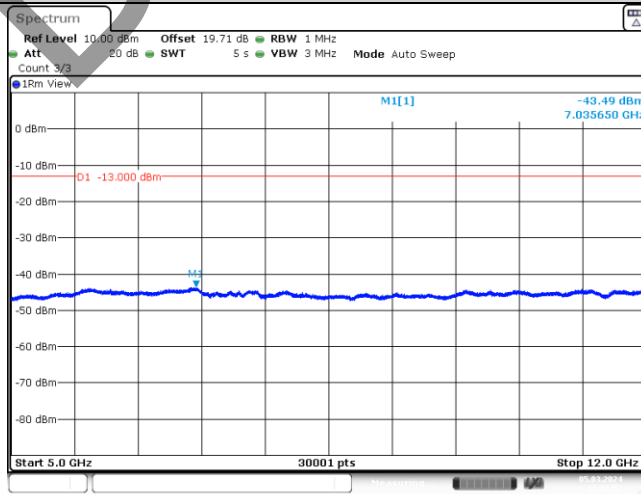

Date: 5.MAR.2024 11:17:53

Band25-20MHz-QPSK-26365-1-0-Low-5000-12000--43.49-PASS

BV 7Layers Communications Technology (Shenzhen) Co., Ltd

Room B37, Warehouse A5, No.3 Chiwan 4th Road, Zhaoshang Street, Nanshan District Shenzhen, Guangdong, People's Republic of China

Tel: +86 755 8869 6566 Fax: +86 755 8869 6577

Email: customerservice.sw@bureauveritas.com



BUREAU VERITAS

Test Report No.: W7L-P23120015R102

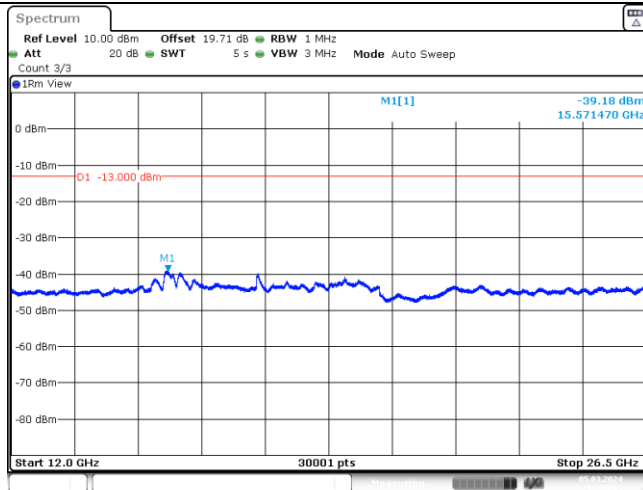

Date: 5.MAR.2024 11:18:14

Band25-20MHz-QPSK-26365-1-0-Low-12000-26500--39.18-PASS

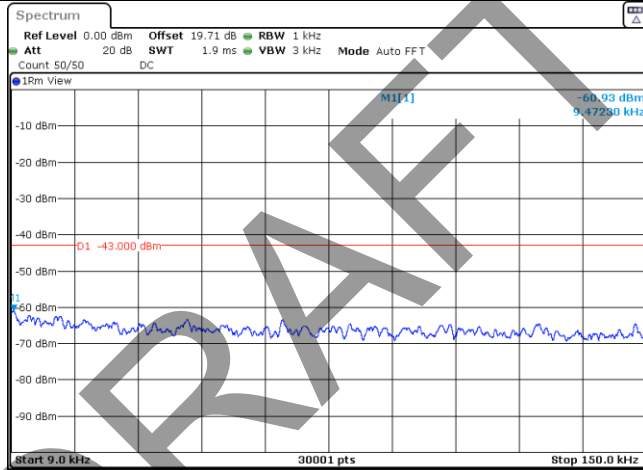

Date: 5.MAR.2024 11:19:41

Band25-20MHz-QPSK-26590-1-0-High-0.009-0.15--60.93-PASS

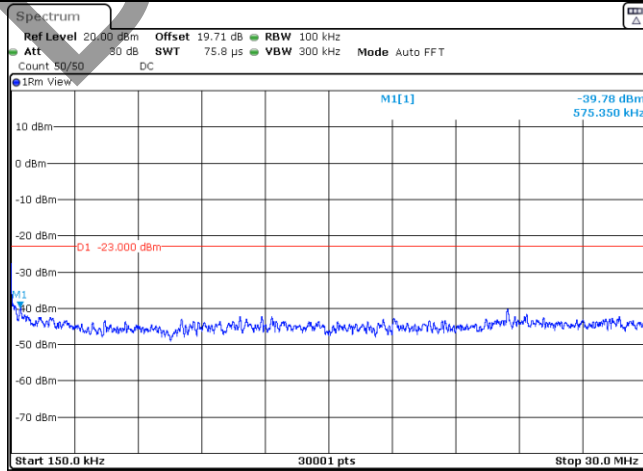

Date: 5.MAR.2024 11:19:46

Band25-20MHz-QPSK-26590-1-0-High-0.15-30--39.78-PASS

BV 7Layers Communications Technology (Shenzhen) Co., Ltd

Room B37, Warehouse A5, No.3 Chiwan 4th Road, Zhaoshang Street, Nanshan District Shenzhen, Guangdong, People's Republic of China

Tel: +86 755 8869 6566 Fax: +86 755 8869 6577

Email: customerservice.sw@bureauveritas.com



BUREAU VERITAS

Test Report No.: W7L-P23120015R102

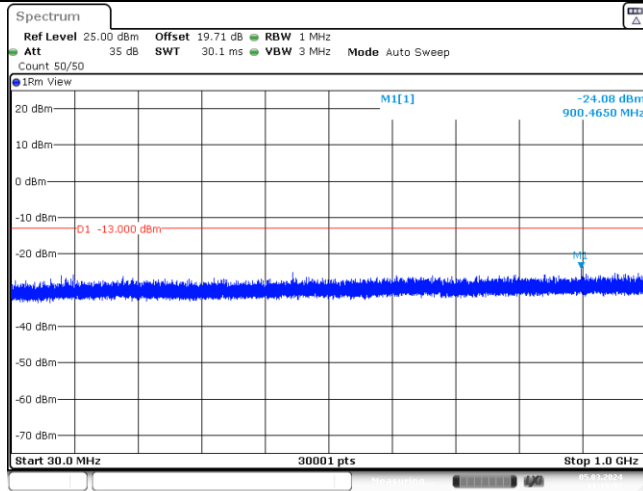

Date: 5.MAR.2024 11:19:52

Band25-20MHz-QPSK-26590-1-0-High-30-1000--24.08-PASS

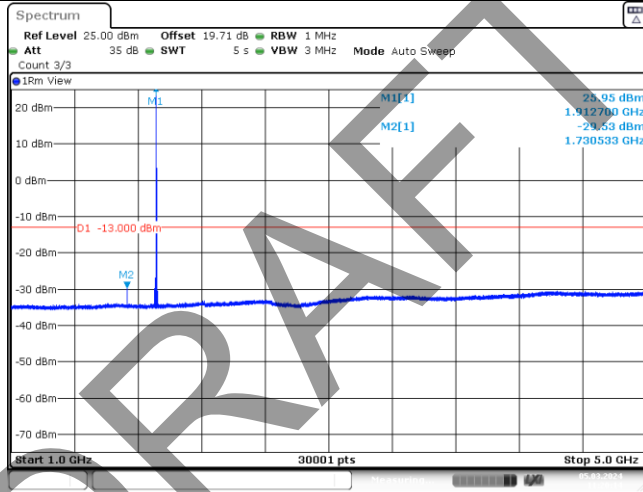

Date: 5.MAR.2024 11:20:14

Band25-20MHz-QPSK-26590-1-0-High-1000-5000--29.53-PASS

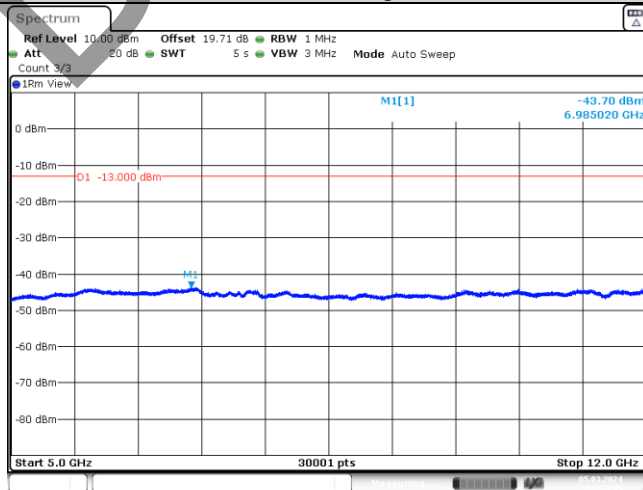

Date: 5.MAR.2024 11:20:35

Band25-20MHz-QPSK-26590-1-0-High-5000-12000--43.7-PASS

BV 7Layers Communications Technology (Shenzhen) Co., Ltd

Room B37, Warehouse A5, No.3 Chiwan 4th Road, Zhaoshang Street, Nanshan District Shenzhen, Guangdong, People's Republic of China

Tel: +86 755 8869 6566 Fax: +86 755 8869 6577

Email: customerservice.sw@bureauveritas.com



BUREAU VERITAS

Test Report No.: W7L-P23120015R102

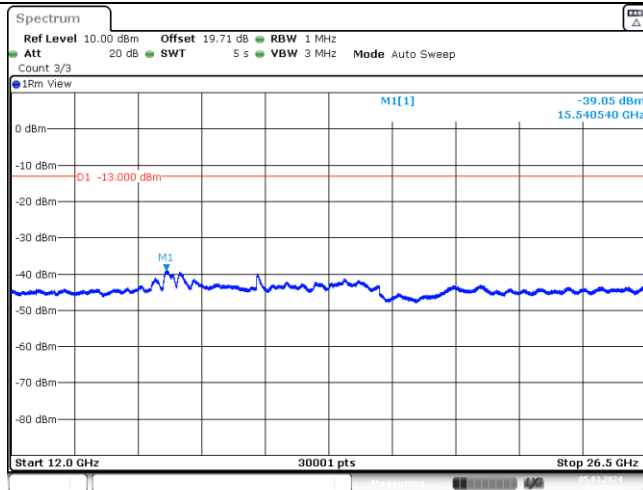

Date: 5.MAR.2024 11:20:56

Band25-20MHz-QPSK-26590-1-0-High-12000-26500--39.05-PASS

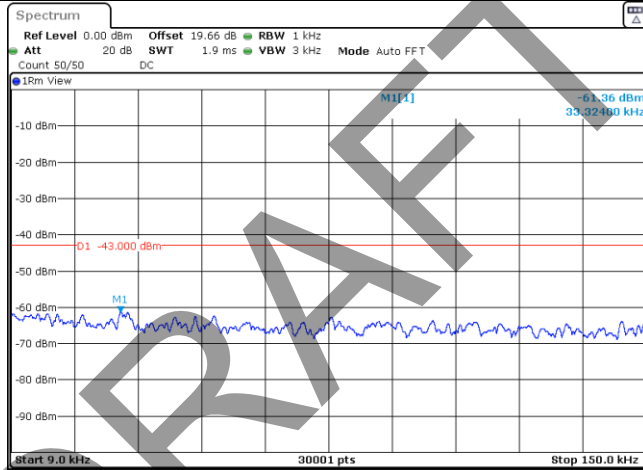

Date: 5.MAR.2024 11:15:37

Band25-20MHz-16QAM-26140-1-0-Low-0.009-0.15--61.36-PASS

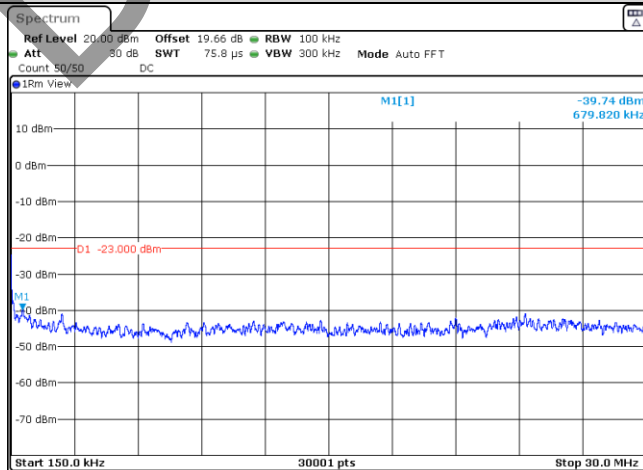

Date: 5.MAR.2024 11:15:41

Band25-20MHz-16QAM-26140-1-0-Low-0.15-30--39.74-PASS

BV 7Layers Communications Technology (Shenzhen) Co., Ltd

Room B37, Warehouse A5, No.3 Chiwan 4th Road, Zhaoshang Street, Nanshan District Shenzhen, Guangdong, People's Republic of China

Tel: +86 755 8869 6566
 Fax: +86 755 8869 6577
 Email: customerservice.sw@bureauveritas.com



BUREAU VERITAS

Test Report No.: W7L-P23120015R102

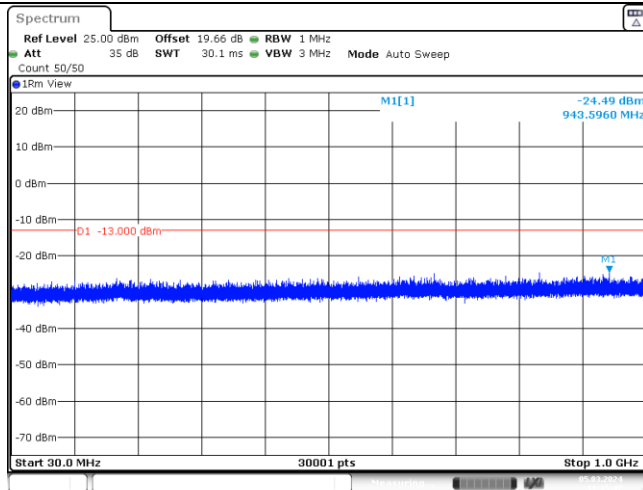

Date: 5.MAR.2024 11:15:48

Band25-20MHz-16QAM-26140-1-0-Low-30-1000--24.49-PASS

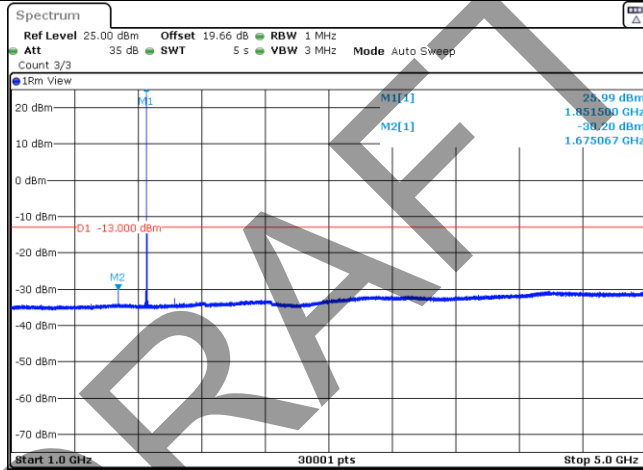

Date: 5.MAR.2024 11:16:10

Band25-20MHz-16QAM-26140-1-0-Low-1000-5000--30.2-PASS

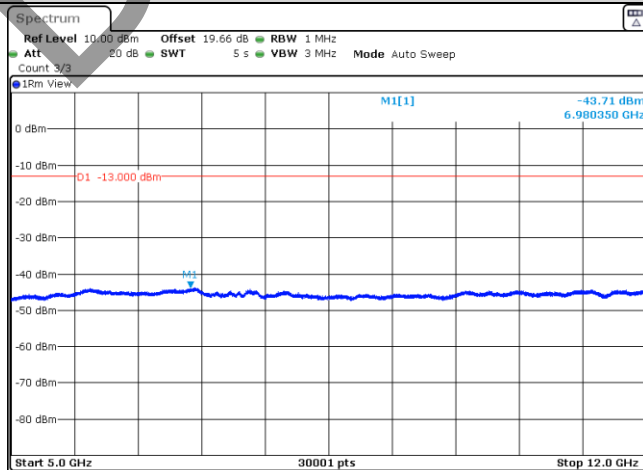

Date: 5.MAR.2024 11:16:31

Band25-20MHz-16QAM-26140-1-0-Low-5000-12000--43.71-PASS

BV 7Layers Communications Technology (Shenzhen) Co., Ltd

Room B37, Warehouse A5, No.3 Chiwan 4th Road, Zhaoshang Street, Nanshan District Shenzhen, Guangdong, People's Republic of China

Tel: +86 755 8869 6566 Fax: +86 755 8869 6577

Email: customerservice.sw@bureauveritas.com



BUREAU VERITAS

Test Report No.: W7L-P23120015R102

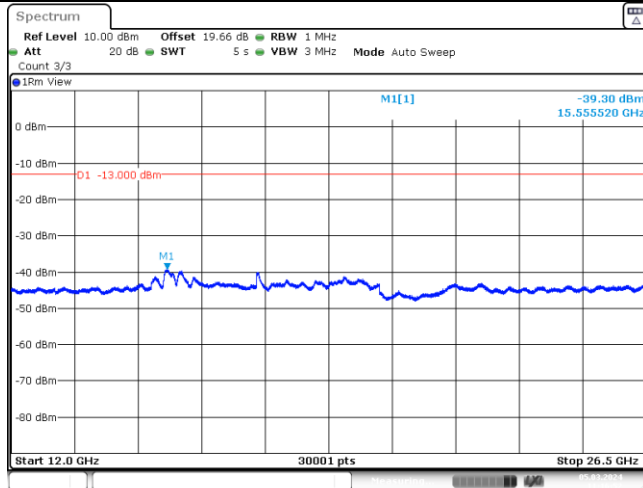

Date: 5.MAR.2024 11:16:52

Band25-20MHz-16QAM-26140-1-0-Low-12000-26500--39.3-PASS

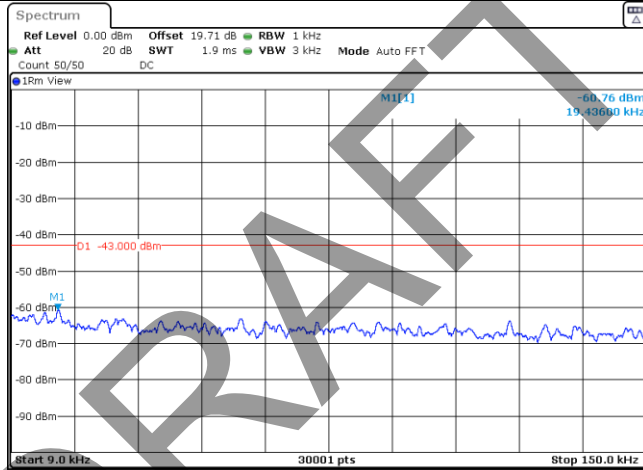

Date: 5.MAR.2024 11:18:19

Band25-20MHz-16QAM-26365-1-0-Low-0.009-0.15--60.76-PASS

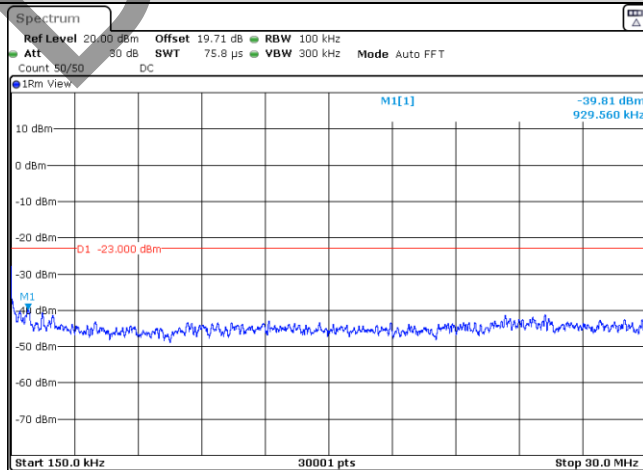

Date: 5.MAR.2024 11:18:24

Band25-20MHz-16QAM-26365-1-0-Low-0.15-30--39.81-PASS

BV 7Layers Communications Technology (Shenzhen) Co., Ltd

Room B37, Warehouse A5, No.3 Chiwan 4th Road, Zhaoshang Street, Nanshan District Shenzhen, Guangdong, People's Republic of China

Tel: +86 755 8869 6566
 Fax: +86 755 8869 6577
 Email: customerservice.sw@bureauveritas.com



BUREAU VERITAS

Test Report No.: W7L-P23120015R102

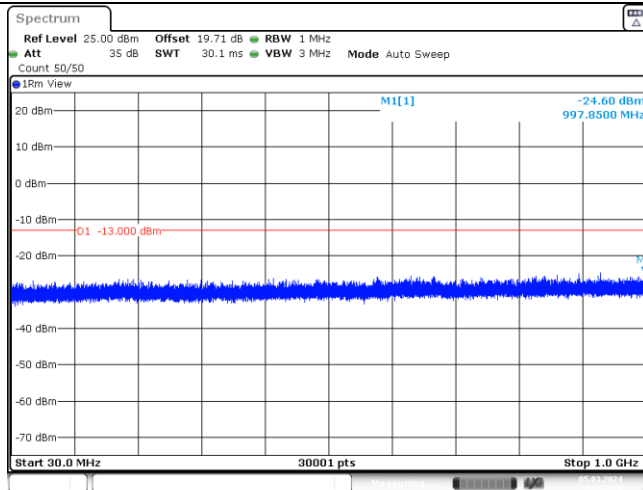

Date: 5.MAR.2024 11:18:30

Band25-20MHz-16QAM-26365-1-0-Low-30-1000--24.6-PASS

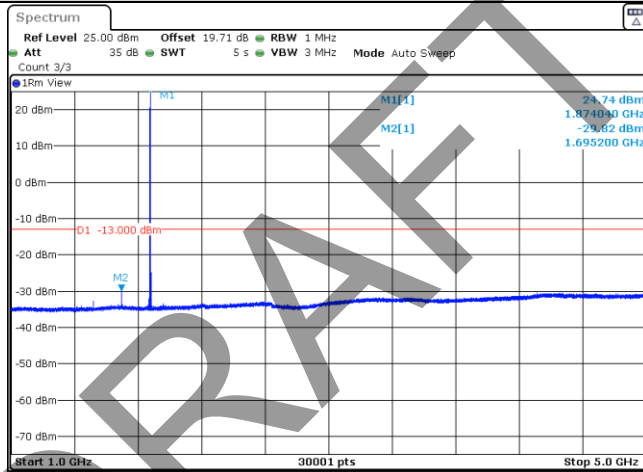

Date: 5.MAR.2024 11:18:52

Band25-20MHz-16QAM-26365-1-0-Low-1000-5000--29.82-PASS

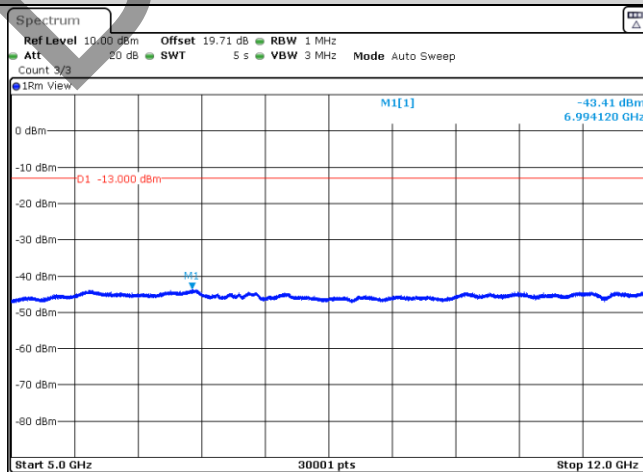

Date: 5.MAR.2024 11:19:13

Band25-20MHz-16QAM-26365-1-0-Low-5000-12000--43.41-PASS

BV 7Layers Communications Technology (Shenzhen) Co., Ltd

Room B37, Warehouse A5, No.3 Chiwan 4th Road, Zhaoshang Street, Nanshan District Shenzhen, Guangdong, People's Republic of China

Tel: +86 755 8869 6566

Fax: +86 755 8869 6577

Email: customerservice.sw@bureauveritas.com



BUREAU VERITAS

Test Report No.: W7L-P23120015R102

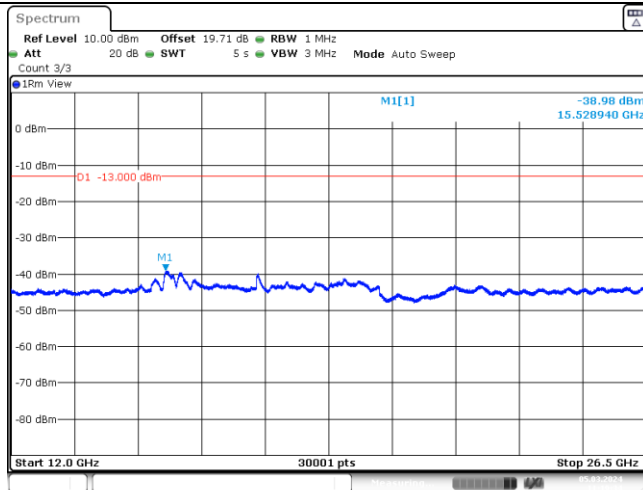

Date: 5.MAR.2024 11:19:34

Band25-20MHz-16QAM-26365-1-0-Low-12000-26500--38.98-PASS

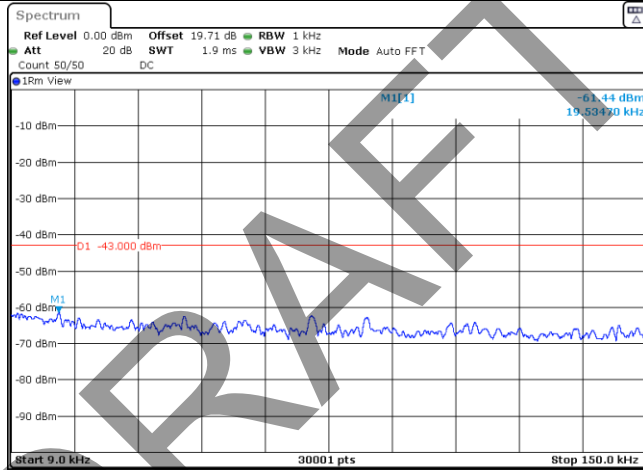

Date: 5.MAR.2024 11:21:01

Band25-20MHz-16QAM-26590-1-0-High-0.009-0.15--61.44-PASS

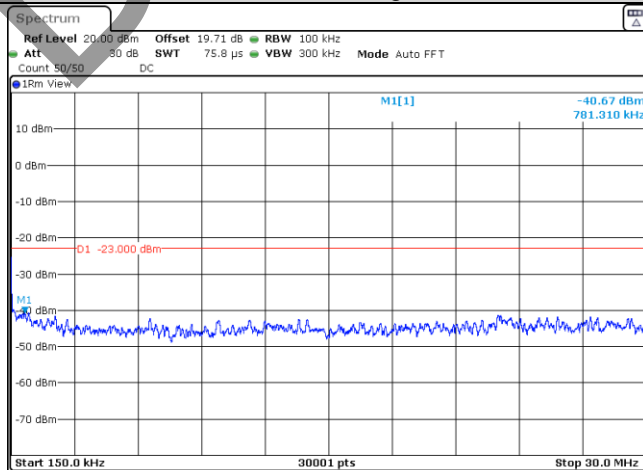

Date: 5.MAR.2024 11:21:06

Band25-20MHz-16QAM-26590-1-0-High-0.15-30--40.67-PASS

BV 7Layers Communications Technology (Shenzhen) Co., Ltd

Room B37, Warehouse A5, No.3 Chiwan 4th Road, Zhaoshang Street, Nanshan District Shenzhen, Guangdong, People's Republic of China

Tel: +86 755 8869 6566 Fax: +86 755 8869 6577

Email: customerservice.sw@bureauveritas.com



BUREAU VERITAS

Test Report No.: W7L-P23120015R102

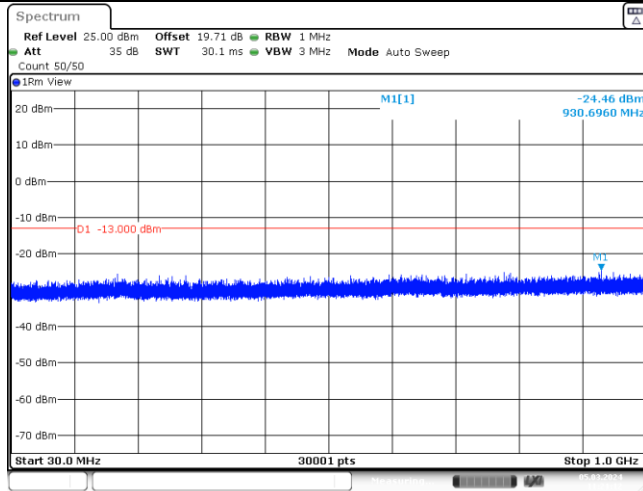

Band25-20MHz-16QAM-26590-1-0-High-30-1000--24.46-PASS

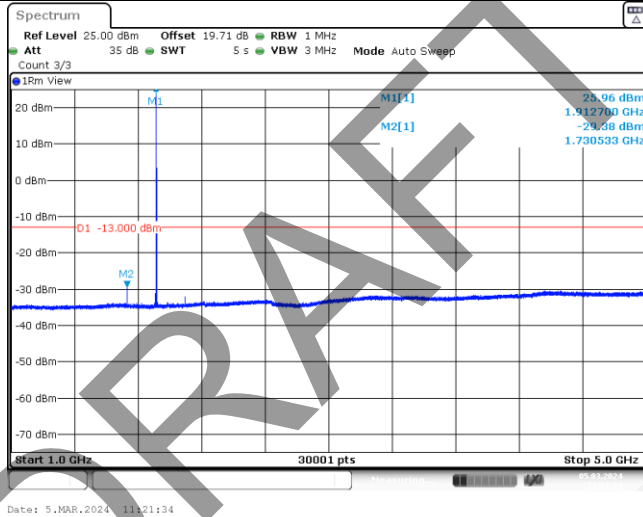

Band25-20MHz-16QAM-26590-1-0-High-1000-5000--29.38-PASS

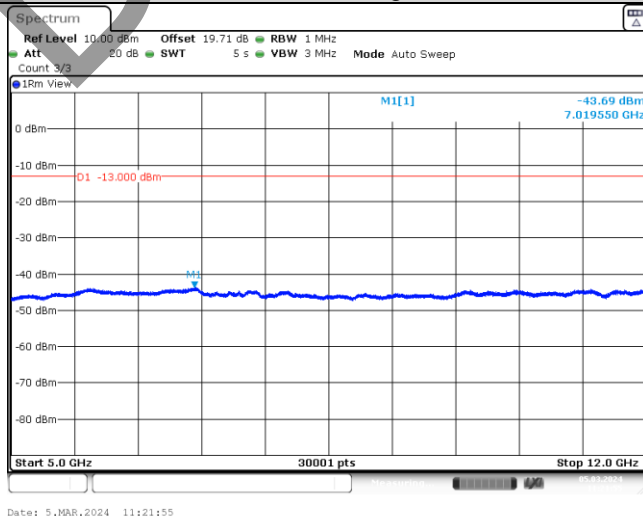

Band25-20MHz-16QAM-26590-1-0-High-5000-12000--43.69-PASS

BV 7Layers Communications Technology (Shenzhen) Co., Ltd

Room B37, Warehouse A5, No.3 Chiwan 4th Road, Zhaoshang Street, Nanshan District Shenzhen, Guangdong, People's Republic of China

Tel: +86 755 8869 6566
 Fax: +86 755 8869 6577
 Email: customerservice.sw@bureauveritas.com



**BUREAU
VERITAS**

Test Report No.: W7L-P23120015R102

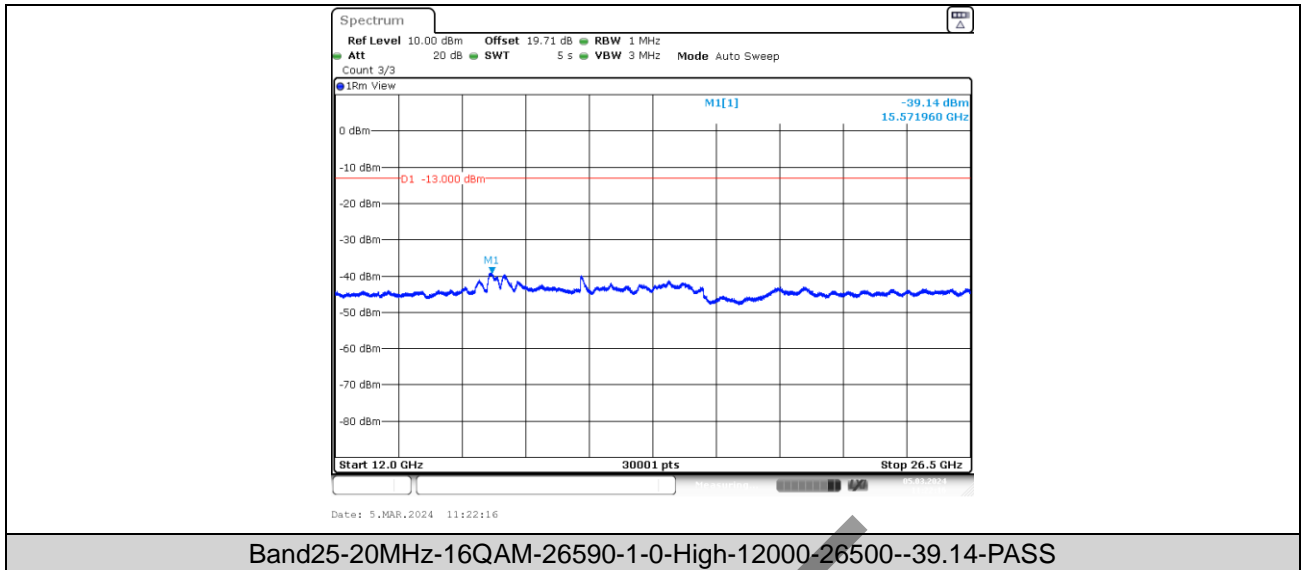

DRAFT



FREQUENCY STABILITY FOR M1 GPRS 1900 TEST RESULT

Voltage						
Band	Channel	Voltage [Vdc]	Temperature (°C)	Deviation (Hz)	Deviation (ppm)	Verdict
GPRS1900	512	VL	NT	31.35	0.016944	PASS
GPRS1900	512	VN	NT	10.36	0.005599	PASS
GPRS1900	512	VH	NT	33.29	0.017993	PASS
GPRS1900	661	VL	NT	5.23	0.002782	PASS
GPRS1900	661	VN	NT	14.43	0.007676	PASS
GPRS1900	661	VH	NT	18.53	0.009856	PASS
GPRS1900	810	VL	NT	11.07	0.005796	PASS
GPRS1900	810	VN	NT	-5.55	-0.002906	PASS
GPRS1900	810	VH	NT	11.88	0.006221	PASS
EGPRS1900	512	VL	NT	24.67	0.013334	PASS
EGPRS1900	512	VN	NT	15.05	0.008134	PASS
EGPRS1900	512	VH	NT	32.09	0.017344	PASS
EGPRS1900	661	VL	NT	17.37	0.009239	PASS
EGPRS1900	661	VN	NT	11.66	0.006202	PASS
EGPRS1900	661	VH	NT	13.82	0.007351	PASS
EGPRS1900	810	VL	NT	20.95	0.01097	PASS
EGPRS1900	810	VN	NT	7.33	0.003838	PASS
EGPRS1900	810	VH	NT	18.21	0.009535	PASS



Temperature						
Band	Channel	Voltage [Vdc]	Temperature (°C)	Deviation (Hz)	Deviation (ppm)	Verdict
GPRS1900	512	NV	-30	33.35	0.018025	PASS
GPRS1900	512	NV	-20	29.67	0.016036	PASS
GPRS1900	512	NV	-10	23.37	0.012631	PASS
GPRS1900	512	NV	0	25.28	0.013663	PASS
GPRS1900	512	NV	10	24.83	0.01342	PASS
GPRS1900	512	NV	20	25.6	0.013836	PASS
GPRS1900	512	NV	30	30.64	0.01656	PASS
GPRS1900	512	NV	40	32.06	0.017328	PASS
GPRS1900	512	NV	50	27.41	0.014815	PASS
GPRS1900	512	NV	60	6.33	0.003421	PASS
GPRS1900	512	NV	70	6.72	0.003632	PASS
GPRS1900	661	NV	-30	11.24	0.005979	PASS
GPRS1900	661	NV	-20	20.79	0.011059	PASS
GPRS1900	661	NV	-10	10.82	0.005755	PASS
GPRS1900	661	NV	0	15.3	0.008138	PASS
GPRS1900	661	NV	10	14.33	0.007622	PASS
GPRS1900	661	NV	20	16.82	0.008947	PASS
GPRS1900	661	NV	30	15.69	0.008346	PASS
GPRS1900	661	NV	40	17.76	0.009447	PASS
GPRS1900	661	NV	50	13.27	0.007059	PASS
GPRS1900	661	NV	60	-7.04	-0.003745	PASS
GPRS1900	661	NV	70	4.58	0.002436	PASS
GPRS1900	810	NV	-30	15.4	0.008064	PASS
GPRS1900	810	NV	-20	19.47	0.010195	PASS



**BUREAU
VERITAS**

Test Report No.: W7L-P23120015R102

GPRS1900	810	NV	-10	11.69	0.006121	PASS
GPRS1900	810	NV	0	5.26	0.002754	PASS
GPRS1900	810	NV	10	20.24	0.010598	PASS
GPRS1900	810	NV	20	11.17	0.005849	PASS
GPRS1900	810	NV	30	16.92	0.00886	PASS
GPRS1900	810	NV	40	5.94	0.00311	PASS
GPRS1900	810	NV	50	15.05	0.00788	PASS
GPRS1900	810	NV	60	14.24	0.007456	PASS
GPRS1900	810	NV	70	12.98	0.006797	PASS
EGPRS1900	512	NV	-30	33.67	0.018198	PASS
EGPRS1900	512	NV	-20	28.64	0.015479	PASS
EGPRS1900	512	NV	-10	33.06	0.017868	PASS
EGPRS1900	512	NV	0	34.38	0.018582	PASS
EGPRS1900	512	NV	10	29.09	0.015723	PASS
EGPRS1900	512	NV	20	25.25	0.013647	PASS
EGPRS1900	512	NV	30	26.44	0.01429	PASS
EGPRS1900	512	NV	40	24.25	0.013107	PASS
EGPRS1900	512	NV	50	26.7	0.014431	PASS
EGPRS1900	512	NV	60	13.17	0.007118	PASS
EGPRS1900	512	NV	70	14.46	0.007815	PASS
EGPRS1900	661	NV	-30	0.29	0.000154	PASS
EGPRS1900	661	NV	-20	16.79	0.008931	PASS
EGPRS1900	661	NV	-10	15.53	0.008261	PASS
EGPRS1900	661	NV	0	12.4	0.006596	PASS
EGPRS1900	661	NV	10	7.65	0.004069	PASS
EGPRS1900	661	NV	20	5.49	0.00292	PASS
EGPRS1900	661	NV	30	2.26	0.001202	PASS
EGPRS1900	661	NV	40	6.55	0.003484	PASS



**BUREAU
VERITAS**

Test Report No.: W7L-P23120015R102

EGPRS1900	661	NV	50	7.62	0.004053	PASS
EGPRS1900	661	NV	60	8.14	0.00433	PASS
EGPRS1900	661	NV	70	-0.87	-0.000463	PASS
EGPRS1900	810	NV	-30	15.72	0.008231	PASS
EGPRS1900	810	NV	-20	11.27	0.005901	PASS
EGPRS1900	810	NV	-10	16.34	0.008556	PASS
EGPRS1900	810	NV	0	20.37	0.010666	PASS
EGPRS1900	810	NV	10	18.08	0.009467	PASS
EGPRS1900	810	NV	20	12.11	0.006341	PASS
EGPRS1900	810	NV	30	24.09	0.012614	PASS
EGPRS1900	810	NV	40	16.08	0.00842	PASS
EGPRS1900	810	NV	50	18.76	0.009823	PASS
EGPRS1900	810	NV	60	10.33	0.005409	PASS
EGPRS1900	810	NV	70	8.94	0.004681	PASS

DRAFT



BAND 2 TEST RESULT

Voltage											
Band	Bandwidth	Modulation	Channel	RB Size	RB Start	NB Index	Voltage [Vdc]	Temperature (°C)	Deviation (Hz)	Deviation (ppm)	Verdict
Band2	1.4MHz	18607	QPSK	6	0	Low	VL	NT	-19.17	-0.010358	PASS
Band2	1.4MHz	18607	QPSK	6	0	Low	VH	NT	-12.9	-0.00697	PASS
Band2	1.4MHz	18607	QPSK	6	0	Low	VN	NT	-20.14	-0.010882	PASS
Band2	1.4MHz	18900	QPSK	6	0	Low	VL	NT	11.32	0.006021	PASS
Band2	1.4MHz	18900	QPSK	6	0	Low	VH	NT	9.04	0.004809	PASS
Band2	1.4MHz	18900	QPSK	6	0	Low	VN	NT	6.62	0.003521	PASS
Band2	1.4MHz	19193	QPSK	6	0	High	VH	NT	-7.1	-0.003719	PASS
Band2	1.4MHz	19193	QPSK	6	0	High	VN	NT	-6.78	-0.003551	PASS
Band2	1.4MHz	19193	QPSK	6	0	High	VL	NT	-8.44	-0.00442	PASS
Band2	1.4MHz	18607	16QAM	6	0	Low	VH	NT	-12.33	-0.006662	PASS
Band2	1.4MHz	18607	16QAM	6	0	Low	VL	NT	-12.43	-0.006716	PASS
Band2	1.4MHz	18607	16QAM	6	0	Low	VN	NT	-24.06	-0.013	PASS
Band2	1.4MHz	18900	16QAM	6	0	Low	VL	NT	12.35	0.006569	PASS
Band2	1.4MHz	18900	16QAM	6	0	Low	VH	NT	9.2	0.004894	PASS
Band2	1.4MHz	18900	16QAM	6	0	Low	VN	NT	10.41	0.005537	PASS
Band2	1.4MHz	19193	16QAM	6	0	High	VH	NT	-7.24	-0.003792	PASS
Band2	1.4MHz	19193	16QAM	6	0	High	VN	NT	4.78	0.002504	PASS
Band2	1.4MHz	19193	16QAM	6	0	High	VL	NT	-5.29	-0.002771	PASS
Band2	3MHz	18615	QPSK	6	0	Low	VN	NT	10.24	0.005531	PASS
Band2	3MHz	18615	QPSK	6	0	Low	VL	NT	8.1	0.004375	PASS
Band2	3MHz	18615	QPSK	6	0	Low	VH	NT	11.4	0.006157	PASS
Band2	3MHz	18900	QPSK	6	0	Low	VN	NT	12.23	0.006505	PASS
Band2	3MHz	18900	QPSK	6	0	Low	VL	NT	-10.04	-0.00534	PASS
Band2	3MHz	18900	QPSK	6	0	Low	VH	NT	14.28	0.007596	PASS



**BUREAU
VERITAS**

Test Report No.: W7L-P23120015R102

Band2	3MHz	19185	QPSK	6	0	High	VN	NT	10.36	0.005428	PASS
Band2	3MHz	19185	QPSK	6	0	High	VH	NT	9.03	0.004731	PASS
Band2	3MHz	19185	QPSK	6	0	High	VL	NT	-17.98	-0.009421	PASS
Band2	3MHz	18615	16QAM	6	0	Low	VN	NT	9.73	0.005255	PASS
Band2	3MHz	18615	16QAM	6	0	Low	VL	NT	8.33	0.004499	PASS
Band2	3MHz	18615	16QAM	6	0	Low	VH	NT	9.06	0.004893	PASS
Band2	3MHz	18900	16QAM	6	0	Low	VN	NT	10.97	0.005835	PASS
Band2	3MHz	18900	16QAM	6	0	Low	VL	NT	10.06	0.005351	PASS
Band2	3MHz	18900	16QAM	6	0	Low	VH	NT	11.8	0.006277	PASS
Band2	3MHz	19185	16QAM	6	0	High	VN	NT	6.95	0.003642	PASS
Band2	3MHz	19185	16QAM	6	0	High	VL	NT	-17.24	-0.009033	PASS
Band2	3MHz	19185	16QAM	6	0	High	VH	NT	13.69	0.007173	PASS
Band2	5MHz	18625	QPSK	6	0	Low	VN	NT	-5.84	-0.003152	PASS
Band2	5MHz	18625	QPSK	6	0	Low	VL	NT	-7.14	-0.003854	PASS
Band2	5MHz	18625	QPSK	6	0	Low	VH	NT	-8.47	-0.004572	PASS
Band2	5MHz	18900	QPSK	6	0	Low	VN	NT	12.99	0.00691	PASS
Band2	5MHz	18900	QPSK	6	0	Low	VH	NT	9.71	0.005165	PASS
Band2	5MHz	18900	QPSK	6	0	Low	VL	NT	10.4	0.005532	PASS
Band2	5MHz	19175	QPSK	6	0	High	VN	NT	-5.74	-0.003009	PASS
Band2	5MHz	19175	QPSK	6	0	High	VL	NT	-6.11	-0.003203	PASS
Band2	5MHz	19175	QPSK	6	0	High	VH	NT	-4.69	-0.002459	PASS
Band2	5MHz	18625	16QAM	6	0	Low	VL	NT	-8.17	-0.00441	PASS
Band2	5MHz	18625	16QAM	6	0	Low	VN	NT	-9.91	-0.00535	PASS
Band2	5MHz	18625	16QAM	6	0	Low	VH	NT	-10.84	-0.005852	PASS
Band2	5MHz	18900	16QAM	6	0	Low	VN	NT	15.98	0.0085	PASS
Band2	5MHz	18900	16QAM	6	0	Low	VL	NT	19.86	0.010564	PASS
Band2	5MHz	18900	16QAM	6	0	Low	VH	NT	14.49	0.007707	PASS
Band2	5MHz	19175	16QAM	6	0	High	VL	NT	4.35	0.00228	PASS

BV 7Layers Communications Technology
(Shenzhen) Co., Ltd

Room B37, Warehouse A5, No.3 Chiwan 4th Road,
Zhaoshang Street, Nanshan District Shenzhen,
Guangdong, People's Republic of China

Tel: +86 755 8869 6566
Fax: +86 755 8869 6577
Email: customerservice.sw@bureauveritas.com



**BUREAU
VERITAS**

Test Report No.: W7L-P23120015R102

Band2	5MHz	19175	16QAM	6	0	High	VN	NT	-8.77	-0.004598	PASS
Band2	5MHz	19175	16QAM	6	0	High	VH	NT	5.55	0.00291	PASS
Band2	10MHz	18650	QPSK	6	0	Low	VL	NT	9.68	0.005218	PASS
Band2	10MHz	18650	QPSK	6	0	Low	VH	NT	10.26	0.005531	PASS
Band2	10MHz	18650	QPSK	6	0	Low	VN	NT	9.91	0.005342	PASS
Band2	10MHz	18900	QPSK	6	0	Low	VL	NT	17.21	0.009154	PASS
Band2	10MHz	18900	QPSK	6	0	Low	VH	NT	16.39	0.008718	PASS
Band2	10MHz	18900	QPSK	6	0	Low	VN	NT	18.77	0.009984	PASS
Band2	10MHz	19150	QPSK	6	0	High	VH	NT	8.17	0.004289	PASS
Band2	10MHz	19150	QPSK	6	0	High	VN	NT	-6.31	-0.003312	PASS
Band2	10MHz	19150	QPSK	6	0	High	VL	NT	-6.49	-0.003407	PASS
Band2	10MHz	18650	16QAM	6	0	Low	VH	NT	11.14	0.006005	PASS
Band2	10MHz	18650	16QAM	6	0	Low	VL	NT	8.53	0.004598	PASS
Band2	10MHz	18650	16QAM	6	0	Low	VN	NT	10.77	0.005806	PASS
Band2	10MHz	18900	16QAM	6	0	Low	VL	NT	18.22	0.009691	PASS
Band2	10MHz	18900	16QAM	6	0	Low	VH	NT	17.4	0.009255	PASS
Band2	10MHz	18900	16QAM	6	0	Low	VN	NT	18.68	0.009936	PASS
Band2	10MHz	19150	16QAM	6	0	High	VH	NT	6.77	0.003554	PASS
Band2	10MHz	19150	16QAM	6	0	High	VN	NT	5.21	0.002735	PASS
Band2	10MHz	19150	16QAM	6	0	High	VL	NT	6.48	0.003402	PASS
Band2	15MHz	18675	QPSK	6	0	Low	VN	NT	12.19	0.006563	PASS
Band2	15MHz	18675	QPSK	6	0	Low	VL	NT	10.41	0.005604	PASS
Band2	15MHz	18675	QPSK	6	0	Low	VH	NT	10.6	0.005707	PASS
Band2	15MHz	18900	QPSK	6	0	Low	VN	NT	10.99	0.005846	PASS
Band2	15MHz	18900	QPSK	6	0	Low	VL	NT	8.05	0.004282	PASS
Band2	15MHz	18900	QPSK	6	0	Low	VH	NT	10.77	0.005729	PASS
Band2	15MHz	19125	QPSK	6	0	High	VN	NT	11.3	0.00594	PASS
Band2	15MHz	19125	QPSK	6	0	High	VH	NT	11.1	0.005834	PASS

BV 7Layers Communications Technology
(Shenzhen) Co., Ltd

Room B37, Warehouse A5, No.3 Chiwan 4th Road,
Zhaoshang Street, Nanshan District Shenzhen,
Guangdong, People's Republic of China

Tel: +86 755 8869 6566
Fax: +86 755 8869 6577
Email: customerservice.sw@bureauveritas.com



**BUREAU
VERITAS**

Test Report No.: W7L-P23120015R102

Band2	15MHz	19125	QPSK	6	0	High	VL	NT	10.94	0.00575	PASS
Band2	15MHz	18675	16QAM	6	0	Low	VN	NT	-33.69	-0.018137	PASS
Band2	15MHz	18675	16QAM	6	0	Low	VL	NT	-37.54	-0.02021	PASS
Band2	15MHz	18675	16QAM	6	0	Low	VH	NT	-36.72	-0.019769	PASS
Band2	15MHz	18900	16QAM	6	0	Low	VN	NT	10.14	0.005394	PASS
Band2	15MHz	18900	16QAM	6	0	Low	VL	NT	9.27	0.004931	PASS
Band2	15MHz	18900	16QAM	6	0	Low	VH	NT	11.01	0.005856	PASS
Band2	15MHz	19125	16QAM	6	0	High	VN	NT	10.47	0.005503	PASS
Band2	15MHz	19125	16QAM	6	0	High	VL	NT	10.14	0.00533	PASS
Band2	15MHz	19125	16QAM	6	0	High	VH	NT	9.07	0.004767	PASS
Band2	20MHz	18700	QPSK	6	0	Low	VN	NT	-16.12	-0.008667	PASS
Band2	20MHz	18700	QPSK	6	0	Low	VL	NT	-13.28	-0.00714	PASS
Band2	20MHz	18700	QPSK	6	0	Low	VH	NT	-12.4	-0.006667	PASS
Band2	20MHz	18900	QPSK	6	0	Low	VN	NT	10.71	0.005697	PASS
Band2	20MHz	18900	QPSK	6	0	Low	VH	NT	12.25	0.006516	PASS
Band2	20MHz	18900	QPSK	6	0	Low	VL	NT	10.71	0.005697	PASS
Band2	20MHz	19100	QPSK	6	0	High	VN	NT	-6.38	-0.003358	PASS
Band2	20MHz	19100	QPSK	6	0	High	VL	NT	-7.47	-0.003932	PASS
Band2	20MHz	19100	QPSK	6	0	High	VH	NT	5.74	0.003021	PASS
Band2	20MHz	18700	16QAM	6	0	Low	VL	NT	-12.09	-0.0065	PASS
Band2	20MHz	18700	16QAM	6	0	Low	VN	NT	-12.72	-0.006839	PASS
Band2	20MHz	18700	16QAM	6	0	Low	VH	NT	-12.35	-0.00664	PASS
Band2	20MHz	18900	16QAM	6	0	Low	VN	NT	11.86	0.006309	PASS
Band2	20MHz	18900	16QAM	6	0	Low	VL	NT	11.07	0.005888	PASS
Band2	20MHz	18900	16QAM	6	0	Low	VH	NT	9.87	0.00525	PASS
Band2	20MHz	19100	16QAM	6	0	High	VH	NT	-6.45	-0.003395	PASS
Band2	20MHz	19100	16QAM	6	0	High	VN	NT	5.97	0.003142	PASS
Band2	20MHz	19100	16QAM	6	0	High	VL	NT	-6.21	-0.003268	PASS

BV 7Layers Communications Technology
(Shenzhen) Co., Ltd

Room B37, Warehouse A5, No.3 Chiwan 4th Road,
Zhaoshang Street, Nanshan District Shenzhen,
Guangdong, People's Republic of China

Tel: +86 755 8869 6566
Fax: +86 755 8869 6577
Email: customerservice.sw@bureauveritas.com



Temperature											
Band	Bandwidth	Modulation	Channel	RB Size	RB Start	NB Index	Voltage [Vdc]	Temperature (°C)	Deviation (Hz)	Deviation (ppm)	Verdict
Band2	1.4MHz	18607	QPSK	6	0	Low	NV	-30	-20.4	-0.011023	PASS
Band2	1.4MHz	18607	QPSK	6	0	Low	NV	70	-12.79	-0.006911	PASS
Band2	1.4MHz	18607	QPSK	6	0	Low	NV	50	-15.25	-0.00824	PASS
Band2	1.4MHz	18607	QPSK	6	0	Low	NV	40	-22.7	-0.012266	PASS
Band2	1.4MHz	18607	QPSK	6	0	Low	NV	30	-12.12	-0.006549	PASS
Band2	1.4MHz	18607	QPSK	6	0	Low	NV	20	-20.6	-0.011131	PASS
Band2	1.4MHz	18607	QPSK	6	0	Low	NV	10	-13.2	-0.007132	PASS
Band2	1.4MHz	18607	QPSK	6	0	Low	NV	0	-24.56	-0.013271	PASS
Band2	1.4MHz	18607	QPSK	6	0	Low	NV	-10	-21.19	-0.01145	PASS
Band2	1.4MHz	18607	QPSK	6	0	Low	NV	-20	-11.96	-0.006462	PASS
Band2	1.4MHz	18607	QPSK	6	0	Low	NV	60	-12.12	-0.006549	PASS
Band2	1.4MHz	18900	QPSK	6	0	Low	NV	-30	10.57	0.005622	PASS
Band2	1.4MHz	18900	QPSK	6	0	Low	NV	10	11.27	0.005995	PASS
Band2	1.4MHz	18900	QPSK	6	0	Low	NV	50	10.73	0.005707	PASS
Band2	1.4MHz	18900	QPSK	6	0	Low	NV	40	12.8	0.006809	PASS
Band2	1.4MHz	18900	QPSK	6	0	Low	NV	30	12.33	0.006559	PASS
Band2	1.4MHz	18900	QPSK	6	0	Low	NV	20	14.48	0.007702	PASS
Band2	1.4MHz	18900	QPSK	6	0	Low	NV	60	9.01	0.004793	PASS
Band2	1.4MHz	18900	QPSK	6	0	Low	NV	-10	10.14	0.005394	PASS
Band2	1.4MHz	18900	QPSK	6	0	Low	NV	-20	11.17	0.005941	PASS
Band2	1.4MHz	18900	QPSK	6	0	Low	NV	70	10.84	0.005766	PASS
Band2	1.4MHz	18900	QPSK	6	0	Low	NV	0	9.48	0.005043	PASS
Band2	1.4MHz	19193	QPSK	6	0	High	NV	-10	-6.87	-0.003598	PASS
Band2	1.4MHz	19193	QPSK	6	0	High	NV	0	-7.31	-0.003829	PASS



Band2	1.4MHz	19193	QPSK	6	0	High	NV	10	-7.98	-0.00418	PASS
Band2	1.4MHz	19193	QPSK	6	0	High	NV	20	-5.71	-0.002991	PASS
Band2	1.4MHz	19193	QPSK	6	0	High	NV	50	-7.1	-0.003719	PASS
Band2	1.4MHz	19193	QPSK	6	0	High	NV	40	-4.85	-0.00254	PASS
Band2	1.4MHz	19193	QPSK	6	0	High	NV	-20	5.88	0.00308	PASS
Band2	1.4MHz	19193	QPSK	6	0	High	NV	30	-7.95	-0.004164	PASS
Band2	1.4MHz	19193	QPSK	6	0	High	NV	70	4.39	0.002299	PASS
Band2	1.4MHz	19193	QPSK	6	0	High	NV	-30	5.59	0.002928	PASS
Band2	1.4MHz	19193	QPSK	6	0	High	NV	60	-5.25	-0.00275	PASS
Band2	1.4MHz	18607	16QAM	6	0	Low	NV	30	-26.88	-0.014524	PASS
Band2	1.4MHz	18607	16QAM	6	0	Low	NV	-30	-13.06	-0.007057	PASS
Band2	1.4MHz	18607	16QAM	6	0	Low	NV	-20	-23.7	-0.012806	PASS
Band2	1.4MHz	18607	16QAM	6	0	Low	NV	-10	-25.71	-0.013892	PASS
Band2	1.4MHz	18607	16QAM	6	0	Low	NV	0	-12.7	-0.006862	PASS
Band2	1.4MHz	18607	16QAM	6	0	Low	NV	60	-26.35	-0.014238	PASS
Band2	1.4MHz	18607	16QAM	6	0	Low	NV	70	-25.76	-0.013919	PASS
Band2	1.4MHz	18607	16QAM	6	0	Low	NV	20	-15.65	-0.008456	PASS
Band2	1.4MHz	18607	16QAM	6	0	Low	NV	40	-14.15	-0.007646	PASS
Band2	1.4MHz	18607	16QAM	6	0	Low	NV	50	-24.02	-0.012979	PASS
Band2	1.4MHz	18607	16QAM	6	0	Low	NV	10	-26.38	-0.014254	PASS
Band2	1.4MHz	18900	16QAM	6	0	Low	NV	70	9.88	0.005255	PASS
Band2	1.4MHz	18900	16QAM	6	0	Low	NV	30	9.36	0.004979	PASS
Band2	1.4MHz	18900	16QAM	6	0	Low	NV	-20	12.7	0.006755	PASS
Band2	1.4MHz	18900	16QAM	6	0	Low	NV	-10	9.37	0.004984	PASS
Band2	1.4MHz	18900	16QAM	6	0	Low	NV	0	12.15	0.006463	PASS
Band2	1.4MHz	18900	16QAM	6	0	Low	NV	20	8.53	0.004537	PASS
Band2	1.4MHz	18900	16QAM	6	0	Low	NV	40	12.69	0.00675	PASS
Band2	1.4MHz	18900	16QAM	6	0	Low	NV	50	11.12	0.005915	PASS



**BUREAU
VERITAS**

Test Report No.: W7L-P23120015R102

Band2	1.4MHz	18900	16QAM	6	0	Low	NV	60	11.63	0.006186	PASS
Band2	1.4MHz	18900	16QAM	6	0	Low	NV	-30	11.03	0.005867	PASS
Band2	1.4MHz	18900	16QAM	6	0	Low	NV	10	8.96	0.004766	PASS
Band2	1.4MHz	19193	16QAM	6	0	High	NV	50	-4.72	-0.002472	PASS
Band2	1.4MHz	19193	16QAM	6	0	High	NV	70	-6.42	-0.003362	PASS
Band2	1.4MHz	19193	16QAM	6	0	High	NV	-20	-8.38	-0.004389	PASS
Band2	1.4MHz	19193	16QAM	6	0	High	NV	40	-7.71	-0.004038	PASS
Band2	1.4MHz	19193	16QAM	6	0	High	NV	30	-7.5	-0.003928	PASS
Band2	1.4MHz	19193	16QAM	6	0	High	NV	20	-7.37	-0.00386	PASS
Band2	1.4MHz	19193	16QAM	6	0	High	NV	10	5.12	0.002682	PASS
Band2	1.4MHz	19193	16QAM	6	0	High	NV	0	-6.39	-0.003347	PASS
Band2	1.4MHz	19193	16QAM	6	0	High	NV	-10	6.15	0.003221	PASS
Band2	1.4MHz	19193	16QAM	6	0	High	NV	-30	-7.25	-0.003797	PASS
Band2	1.4MHz	19193	16QAM	6	0	High	NV	60	5.94	0.003111	PASS
Band2	3MHz	18615	QPSK	6	0	Low	NV	30	13.33	0.0072	PASS
Band2	3MHz	18615	QPSK	6	0	Low	NV	40	12.57	0.006789	PASS
Band2	3MHz	18615	QPSK	6	0	Low	NV	-30	8	0.004321	PASS
Band2	3MHz	18615	QPSK	6	0	Low	NV	70	9.51	0.005136	PASS
Band2	3MHz	18615	QPSK	6	0	Low	NV	50	4.96	0.002679	PASS
Band2	3MHz	18615	QPSK	6	0	Low	NV	10	7.81	0.004218	PASS
Band2	3MHz	18615	QPSK	6	0	Low	NV	60	8.47	0.004575	PASS
Band2	3MHz	18615	QPSK	6	0	Low	NV	0	8.55	0.004618	PASS
Band2	3MHz	18615	QPSK	6	0	Low	NV	-10	8.51	0.004596	PASS
Band2	3MHz	18615	QPSK	6	0	Low	NV	-20	9.08	0.004904	PASS
Band2	3MHz	18615	QPSK	6	0	Low	NV	20	8.84	0.004775	PASS
Band2	3MHz	18900	QPSK	6	0	Low	NV	50	11.9	0.00633	PASS
Band2	3MHz	18900	QPSK	6	0	Low	NV	-30	13.06	0.006947	PASS
Band2	3MHz	18900	QPSK	6	0	Low	NV	-20	11.97	0.006367	PASS

BV 7Layers Communications Technology
(Shenzhen) Co., Ltd

Room B37, Warehouse A5, No.3 Chiwan 4th Road,
Zhaoshang Street, Nanshan District Shenzhen,
Guangdong, People's Republic of China

Tel: +86 755 8869 6566
Fax: +86 755 8869 6577
Email: customerservice.sw@bureauveritas.com



**BUREAU
VERITAS**

Test Report No.: W7L-P23120015R102

Band2	3MHz	18900	QPSK	6	0	Low	NV	-10	-11.67	-0.006207	PASS
Band2	3MHz	18900	QPSK	6	0	Low	NV	0	15.18	0.008074	PASS
Band2	3MHz	18900	QPSK	6	0	Low	NV	10	11.46	0.006096	PASS
Band2	3MHz	18900	QPSK	6	0	Low	NV	20	11.62	0.006181	PASS
Band2	3MHz	18900	QPSK	6	0	Low	NV	40	12.17	0.006473	PASS
Band2	3MHz	18900	QPSK	6	0	Low	NV	60	10.7	0.005691	PASS
Band2	3MHz	18900	QPSK	6	0	Low	NV	70	-10.41	-0.005537	PASS
Band2	3MHz	18900	QPSK	6	0	Low	NV	30	12.29	0.006537	PASS
Band2	3MHz	19185	QPSK	6	0	High	NV	50	10.7	0.005606	PASS
Band2	3MHz	19185	QPSK	6	0	High	NV	60	9.43	0.004941	PASS
Band2	3MHz	19185	QPSK	6	0	High	NV	40	8.25	0.004323	PASS
Band2	3MHz	19185	QPSK	6	0	High	NV	30	9.67	0.005067	PASS
Band2	3MHz	19185	QPSK	6	0	High	NV	20	8.15	0.00427	PASS
Band2	3MHz	19185	QPSK	6	0	High	NV	10	-16.85	-0.008829	PASS
Band2	3MHz	19185	QPSK	6	0	High	NV	0	8.78	0.0046	PASS
Band2	3MHz	19185	QPSK	6	0	High	NV	-10	8.68	0.004548	PASS
Band2	3MHz	19185	QPSK	6	0	High	NV	-20	-20.86	-0.01093	PASS
Band2	3MHz	19185	QPSK	6	0	High	NV	-30	10.79	0.005654	PASS
Band2	3MHz	19185	QPSK	6	0	High	NV	70	-17.91	-0.009384	PASS
Band2	3MHz	18615	16QAM	6	0	Low	NV	-30	10.5	0.005671	PASS
Band2	3MHz	18615	16QAM	6	0	Low	NV	70	12.29	0.006638	PASS
Band2	3MHz	18615	16QAM	6	0	Low	NV	60	10.17	0.005493	PASS
Band2	3MHz	18615	16QAM	6	0	Low	NV	50	8.28	0.004472	PASS
Band2	3MHz	18615	16QAM	6	0	Low	NV	40	9.27	0.005007	PASS
Band2	3MHz	18615	16QAM	6	0	Low	NV	30	10.04	0.005423	PASS
Band2	3MHz	18615	16QAM	6	0	Low	NV	20	10.1	0.005455	PASS
Band2	3MHz	18615	16QAM	6	0	Low	NV	10	9.5	0.005131	PASS
Band2	3MHz	18615	16QAM	6	0	Low	NV	0	10.54	0.005693	PASS

BV 7Layers Communications Technology
(Shenzhen) Co., Ltd

Room B37, Warehouse A5, No.3 Chiwan 4th Road,
Zhaoshang Street, Nanshan District Shenzhen,
Guangdong, People's Republic of China

Tel: +86 755 8869 6566
Fax: +86 755 8869 6577
Email: customerservice.sw@bureauveritas.com



**BUREAU
VERITAS**

Test Report No.: W7L-P23120015R102

Band2	3MHz	18615	16QAM	6	0	Low	NV	-20	9.46	0.005109	PASS
Band2	3MHz	18615	16QAM	6	0	Low	NV	-10	12.15	0.006562	PASS
Band2	3MHz	18900	16QAM	6	0	Low	NV	0	13.05	0.006941	PASS
Band2	3MHz	18900	16QAM	6	0	Low	NV	-30	14.03	0.007463	PASS
Band2	3MHz	18900	16QAM	6	0	Low	NV	-10	14.91	0.007931	PASS
Band2	3MHz	18900	16QAM	6	0	Low	NV	10	14.63	0.007782	PASS
Band2	3MHz	18900	16QAM	6	0	Low	NV	20	10.77	0.005729	PASS
Band2	3MHz	18900	16QAM	6	0	Low	NV	30	13.46	0.00716	PASS
Band2	3MHz	18900	16QAM	6	0	Low	NV	40	11.36	0.006043	PASS
Band2	3MHz	18900	16QAM	6	0	Low	NV	50	11.7	0.006223	PASS
Band2	3MHz	18900	16QAM	6	0	Low	NV	60	10.89	0.005793	PASS
Band2	3MHz	18900	16QAM	6	0	Low	NV	70	10.5	0.005585	PASS
Band2	3MHz	18900	16QAM	6	0	Low	NV	-20	10.64	0.00566	PASS
Band2	3MHz	19185	16QAM	6	0	High	NV	-20	7.98	0.004181	PASS
Band2	3MHz	19185	16QAM	6	0	High	NV	30	5.21	0.00273	PASS
Band2	3MHz	19185	16QAM	6	0	High	NV	70	6.15	0.003222	PASS
Band2	3MHz	19185	16QAM	6	0	High	NV	60	-17.92	-0.00939	PASS
Band2	3MHz	19185	16QAM	6	0	High	NV	50	8.91	0.004669	PASS
Band2	3MHz	19185	16QAM	6	0	High	NV	40	8.85	0.004637	PASS
Band2	3MHz	19185	16QAM	6	0	High	NV	20	6.64	0.003479	PASS
Band2	3MHz	19185	16QAM	6	0	High	NV	10	7.93	0.004155	PASS
Band2	3MHz	19185	16QAM	6	0	High	NV	-10	9.71	0.005088	PASS
Band2	3MHz	19185	16QAM	6	0	High	NV	-30	7.42	0.003888	PASS
Band2	3MHz	19185	16QAM	6	0	High	NV	0	9.16	0.0048	PASS
Band2	5MHz	18625	QPSK	6	0	Low	NV	30	-7.85	-0.004238	PASS
Band2	5MHz	18625	QPSK	6	0	Low	NV	70	-9.06	-0.004891	PASS
Band2	5MHz	18625	QPSK	6	0	Low	NV	60	-9.06	-0.004891	PASS
Band2	5MHz	18625	QPSK	6	0	Low	NV	50	-9.1	-0.004912	PASS

BV 7Layers Communications Technology
(Shenzhen) Co., Ltd

Room B37, Warehouse A5, No.3 Chiwan 4th Road,
Zhaoshang Street, Nanshan District Shenzhen,
Guangdong, People's Republic of China

Tel: +86 755 8869 6566
Fax: +86 755 8869 6577
Email: customerservice.sw@bureauveritas.com



**BUREAU
VERITAS**

Test Report No.: W7L-P23120015R102

Band2	5MHz	18625	QPSK	6	0	Low	NV	40	-6.85	-0.003698	PASS
Band2	5MHz	18625	QPSK	6	0	Low	NV	10	-7.78	-0.0042	PASS
Band2	5MHz	18625	QPSK	6	0	Low	NV	0	-10.3	-0.00556	PASS
Band2	5MHz	18625	QPSK	6	0	Low	NV	-10	-9.14	-0.004934	PASS
Band2	5MHz	18625	QPSK	6	0	Low	NV	-20	-8.65	-0.004669	PASS
Band2	5MHz	18625	QPSK	6	0	Low	NV	20	-9.37	-0.005058	PASS
Band2	5MHz	18625	QPSK	6	0	Low	NV	-30	-8.93	-0.004821	PASS
Band2	5MHz	18900	QPSK	6	0	Low	NV	60	13.05	0.006941	PASS
Band2	5MHz	18900	QPSK	6	0	Low	NV	-30	10.8	0.005745	PASS
Band2	5MHz	18900	QPSK	6	0	Low	NV	-20	13.68	0.007277	PASS
Band2	5MHz	18900	QPSK	6	0	Low	NV	-10	11.84	0.006298	PASS
Band2	5MHz	18900	QPSK	6	0	Low	NV	0	11.93	0.006346	PASS
Band2	5MHz	18900	QPSK	6	0	Low	NV	10	11.44	0.006085	PASS
Band2	5MHz	18900	QPSK	6	0	Low	NV	20	11.23	0.005973	PASS
Band2	5MHz	18900	QPSK	6	0	Low	NV	30	13.98	0.007436	PASS
Band2	5MHz	18900	QPSK	6	0	Low	NV	50	13.56	0.007213	PASS
Band2	5MHz	18900	QPSK	6	0	Low	NV	70	16.28	0.00866	PASS
Band2	5MHz	18900	QPSK	6	0	Low	NV	40	12.7	0.006755	PASS
Band2	5MHz	19175	QPSK	6	0	High	NV	70	-5.48	-0.002873	PASS
Band2	5MHz	19175	QPSK	6	0	High	NV	60	-6.37	-0.003339	PASS
Band2	5MHz	19175	QPSK	6	0	High	NV	50	-5.75	-0.003014	PASS
Band2	5MHz	19175	QPSK	6	0	High	NV	40	-5.98	-0.003135	PASS
Band2	5MHz	19175	QPSK	6	0	High	NV	30	-8.41	-0.004409	PASS
Band2	5MHz	19175	QPSK	6	0	High	NV	20	-5.49	-0.002878	PASS
Band2	5MHz	19175	QPSK	6	0	High	NV	10	-6.27	-0.003287	PASS
Band2	5MHz	19175	QPSK	6	0	High	NV	0	-6.45	-0.003381	PASS
Band2	5MHz	19175	QPSK	6	0	High	NV	-10	-6.57	-0.003444	PASS
Band2	5MHz	19175	QPSK	6	0	High	NV	-20	-7.58	-0.003974	PASS

BV 7Layers Communications Technology
(Shenzhen) Co., Ltd

Room B37, Warehouse A5, No.3 Chiwan 4th Road,
Zhaoshang Street, Nanshan District Shenzhen,
Guangdong, People's Republic of China

Tel: +86 755 8869 6566
Fax: +86 755 8869 6577
Email: customerservice.sw@bureauveritas.com



**BUREAU
VERITAS**

Test Report No.: W7L-P23120015R102

Band2	5MHz	19175	QPSK	6	0	High	NV	-30	-7.52	-0.003942	PASS
Band2	5MHz	18625	16QAM	6	0	Low	NV	0	-8.96	-0.004837	PASS
Band2	5MHz	18625	16QAM	6	0	Low	NV	70	-7.67	-0.00414	PASS
Band2	5MHz	18625	16QAM	6	0	Low	NV	60	-7.78	-0.0042	PASS
Band2	5MHz	18625	16QAM	6	0	Low	NV	50	-10.66	-0.005754	PASS
Band2	5MHz	18625	16QAM	6	0	Low	NV	40	-8.63	-0.004659	PASS
Band2	5MHz	18625	16QAM	6	0	Low	NV	30	-8.63	-0.004659	PASS
Band2	5MHz	18625	16QAM	6	0	Low	NV	10	-7.25	-0.003914	PASS
Band2	5MHz	18625	16QAM	6	0	Low	NV	-10	-9.37	-0.005058	PASS
Band2	5MHz	18625	16QAM	6	0	Low	NV	-20	-9.33	-0.005036	PASS
Band2	5MHz	18625	16QAM	6	0	Low	NV	-30	-9.2	-0.004966	PASS
Band2	5MHz	18625	16QAM	6	0	Low	NV	20	-10.01	-0.005404	PASS
Band2	5MHz	18900	16QAM	6	0	Low	NV	-20	9.06	0.004819	PASS
Band2	5MHz	18900	16QAM	6	0	Low	NV	-30	13.12	0.006979	PASS
Band2	5MHz	18900	16QAM	6	0	Low	NV	-10	12.25	0.006516	PASS
Band2	5MHz	18900	16QAM	6	0	Low	NV	0	12.06	0.006415	PASS
Band2	5MHz	18900	16QAM	6	0	Low	NV	10	13.65	0.007261	PASS
Band2	5MHz	18900	16QAM	6	0	Low	NV	30	12.42	0.006606	PASS
Band2	5MHz	18900	16QAM	6	0	Low	NV	40	12.49	0.006644	PASS
Band2	5MHz	18900	16QAM	6	0	Low	NV	50	14.1	0.0075	PASS
Band2	5MHz	18900	16QAM	6	0	Low	NV	60	11.84	0.006298	PASS
Band2	5MHz	18900	16QAM	6	0	Low	NV	70	12.9	0.006862	PASS
Band2	5MHz	18900	16QAM	6	0	Low	NV	20	14.06	0.007479	PASS
Band2	5MHz	19175	16QAM	6	0	High	NV	-20	-6.18	-0.00324	PASS
Band2	5MHz	19175	16QAM	6	0	High	NV	70	-5.25	-0.002752	PASS
Band2	5MHz	19175	16QAM	6	0	High	NV	60	-6.55	-0.003434	PASS
Band2	5MHz	19175	16QAM	6	0	High	NV	50	6.68	0.003502	PASS
Band2	5MHz	19175	16QAM	6	0	High	NV	40	6.44	0.003376	PASS

BV 7Layers Communications Technology
(Shenzhen) Co., Ltd

Room B37, Warehouse A5, No.3 Chiwan 4th Road,
Zhaoshang Street, Nanshan District Shenzhen,
Guangdong, People's Republic of China

Tel: +86 755 8869 6566
Fax: +86 755 8869 6577
Email: customerservice.sw@bureauveritas.com



**BUREAU
VERITAS**

Test Report No.: W7L-P23120015R102

Band2	5MHz	19175	16QAM	6	0	High	NV	30	-5.91	-0.003098	PASS
Band2	5MHz	19175	16QAM	6	0	High	NV	20	-7.57	-0.003969	PASS
Band2	5MHz	19175	16QAM	6	0	High	NV	10	-6.87	-0.003602	PASS
Band2	5MHz	19175	16QAM	6	0	High	NV	-10	-4.95	-0.002595	PASS
Band2	5MHz	19175	16QAM	6	0	High	NV	-30	-6.38	-0.003345	PASS
Band2	5MHz	19175	16QAM	6	0	High	NV	0	-6.47	-0.003392	PASS
Band2	10MHz	18650	QPSK	6	0	Low	NV	70	10.13	0.005461	PASS
Band2	10MHz	18650	QPSK	6	0	Low	NV	60	9.43	0.005084	PASS
Band2	10MHz	18650	QPSK	6	0	Low	NV	50	9.5	0.005121	PASS
Band2	10MHz	18650	QPSK	6	0	Low	NV	40	10.03	0.005407	PASS
Band2	10MHz	18650	QPSK	6	0	Low	NV	30	10.29	0.005547	PASS
Band2	10MHz	18650	QPSK	6	0	Low	NV	10	9.93	0.005353	PASS
Band2	10MHz	18650	QPSK	6	0	Low	NV	0	11.16	0.006016	PASS
Band2	10MHz	18650	QPSK	6	0	Low	NV	-10	9.6	0.005175	PASS
Band2	10MHz	18650	QPSK	6	0	Low	NV	-20	9.74	0.005251	PASS
Band2	10MHz	18650	QPSK	6	0	Low	NV	-30	10.16	0.005477	PASS
Band2	10MHz	18650	QPSK	6	0	Low	NV	20	10.73	0.005784	PASS
Band2	10MHz	18900	QPSK	6	0	Low	NV	-30	17.18	0.009138	PASS
Band2	10MHz	18900	QPSK	6	0	Low	NV	-20	17.77	0.009452	PASS
Band2	10MHz	18900	QPSK	6	0	Low	NV	-10	18.15	0.009654	PASS
Band2	10MHz	18900	QPSK	6	0	Low	NV	0	17.37	0.009239	PASS
Band2	10MHz	18900	QPSK	6	0	Low	NV	10	19.63	0.010441	PASS
Band2	10MHz	18900	QPSK	6	0	Low	NV	20	17.82	0.009479	PASS
Band2	10MHz	18900	QPSK	6	0	Low	NV	30	18.1	0.009628	PASS
Band2	10MHz	18900	QPSK	6	0	Low	NV	60	19.31	0.010271	PASS
Band2	10MHz	18900	QPSK	6	0	Low	NV	50	20.86	0.011096	PASS
Band2	10MHz	18900	QPSK	6	0	Low	NV	40	15.51	0.00825	PASS
Band2	10MHz	18900	QPSK	6	0	Low	NV	70	17.74	0.009436	PASS

BV 7Layers Communications Technology
(Shenzhen) Co., Ltd

Room B37, Warehouse A5, No.3 Chiwan 4th Road,
Zhaoshang Street, Nanshan District Shenzhen,
Guangdong, People's Republic of China

Tel: +86 755 8869 6566
Fax: +86 755 8869 6577
Email: customerservice.sw@bureauveritas.com



Band2	10MHz	19150	QPSK	6	0	High	NV	-30	5.89	0.003092	PASS
Band2	10MHz	19150	QPSK	6	0	High	NV	-20	-6.38	-0.003349	PASS
Band2	10MHz	19150	QPSK	6	0	High	NV	-10	-5.91	-0.003102	PASS
Band2	10MHz	19150	QPSK	6	0	High	NV	0	9.44	0.004955	PASS
Band2	10MHz	19150	QPSK	6	0	High	NV	10	7.41	0.00389	PASS
Band2	10MHz	19150	QPSK	6	0	High	NV	20	-4.72	-0.002478	PASS
Band2	10MHz	19150	QPSK	6	0	High	NV	30	10.24	0.005375	PASS
Band2	10MHz	19150	QPSK	6	0	High	NV	40	-7	-0.003675	PASS
Band2	10MHz	19150	QPSK	6	0	High	NV	50	6.44	0.003381	PASS
Band2	10MHz	19150	QPSK	6	0	High	NV	60	7.48	0.003927	PASS
Band2	10MHz	19150	QPSK	6	0	High	NV	70	6.82	0.00358	PASS
Band2	10MHz	18650	16QAM	6	0	Low	NV	20	10.86	0.005854	PASS
Band2	10MHz	18650	16QAM	6	0	Low	NV	70	13.09	0.007057	PASS
Band2	10MHz	18650	16QAM	6	0	Low	NV	60	11.93	0.006431	PASS
Band2	10MHz	18650	16QAM	6	0	Low	NV	50	12.33	0.006647	PASS
Band2	10MHz	18650	16QAM	6	0	Low	NV	-30	11.66	0.006286	PASS
Band2	10MHz	18650	16QAM	6	0	Low	NV	30	11.3	0.006092	PASS
Band2	10MHz	18650	16QAM	6	0	Low	NV	10	11.04	0.005951	PASS
Band2	10MHz	18650	16QAM	6	0	Low	NV	0	11.39	0.00614	PASS
Band2	10MHz	18650	16QAM	6	0	Low	NV	-10	13.46	0.007256	PASS
Band2	10MHz	18650	16QAM	6	0	Low	NV	-20	10.81	0.005827	PASS
Band2	10MHz	18650	16QAM	6	0	Low	NV	40	12.65	0.006819	PASS
Band2	10MHz	18900	16QAM	6	0	Low	NV	50	19.83	0.010548	PASS
Band2	10MHz	18900	16QAM	6	0	Low	NV	-20	17.72	0.009426	PASS
Band2	10MHz	18900	16QAM	6	0	Low	NV	70	18.38	0.009777	PASS
Band2	10MHz	18900	16QAM	6	0	Low	NV	-30	19.14	0.010181	PASS
Band2	10MHz	18900	16QAM	6	0	Low	NV	-10	17.62	0.009372	PASS
Band2	10MHz	18900	16QAM	6	0	Low	NV	0	18.48	0.00983	PASS



BUREAU
VERITAS

Test Report No.: W7L-P23120015R102

Band2	10MHz	18900	16QAM	6	0	Low	NV	10	18.48	0.00983	PASS
Band2	10MHz	18900	16QAM	6	0	Low	NV	20	19.48	0.010362	PASS
Band2	10MHz	18900	16QAM	6	0	Low	NV	30	17.29	0.009197	PASS
Band2	10MHz	18900	16QAM	6	0	Low	NV	40	17.78	0.009457	PASS
Band2	10MHz	18900	16QAM	6	0	Low	NV	60	18.2	0.009681	PASS
Band2	10MHz	19150	16QAM	6	0	High	NV	30	7.81	0.0041	PASS
Band2	10MHz	19150	16QAM	6	0	High	NV	70	4.94	0.002593	PASS
Band2	10MHz	19150	16QAM	6	0	High	NV	60	5.02	0.002635	PASS
Band2	10MHz	19150	16QAM	6	0	High	NV	50	-4.03	-0.002115	PASS
Band2	10MHz	19150	16QAM	6	0	High	NV	40	4.32	0.002268	PASS
Band2	10MHz	19150	16QAM	6	0	High	NV	10	5.55	0.002913	PASS
Band2	10MHz	19150	16QAM	6	0	High	NV	0	8.87	0.004656	PASS
Band2	10MHz	19150	16QAM	6	0	High	NV	-10	7.05	0.003701	PASS
Band2	10MHz	19150	16QAM	6	0	High	NV	-20	5.91	0.003102	PASS
Band2	10MHz	19150	16QAM	6	0	High	NV	-30	5.78	0.003034	PASS
Band2	10MHz	19150	16QAM	6	0	High	NV	20	5.04	0.002646	PASS
Band2	15MHz	18675	QPSK	6	0	Low	NV	60	-37.18	-0.020016	PASS
Band2	15MHz	18675	QPSK	6	0	Low	NV	70	-34.48	-0.018563	PASS
Band2	15MHz	18675	QPSK	6	0	Low	NV	50	-34.22	-0.018423	PASS
Band2	15MHz	18675	QPSK	6	0	Low	NV	40	10.5	0.005653	PASS
Band2	15MHz	18675	QPSK	6	0	Low	NV	30	12.62	0.006794	PASS
Band2	15MHz	18675	QPSK	6	0	Low	NV	10	10.67	0.005744	PASS
Band2	15MHz	18675	QPSK	6	0	Low	NV	0	9.53	0.005131	PASS
Band2	15MHz	18675	QPSK	6	0	Low	NV	-10	10.56	0.005685	PASS
Band2	15MHz	18675	QPSK	6	0	Low	NV	-20	9.04	0.004867	PASS
Band2	15MHz	18675	QPSK	6	0	Low	NV	-30	10.53	0.005669	PASS
Band2	15MHz	18675	QPSK	6	0	Low	NV	20	9.91	0.005335	PASS
Band2	15MHz	18900	QPSK	6	0	Low	NV	50	10.76	0.005723	PASS

BV 7Layers Communications Technology
(Shenzhen) Co., Ltd

Room B37, Warehouse A5, No.3 Chiwan 4th Road,
Zhaoshang Street, Nanshan District Shenzhen,
Guangdong, People's Republic of China

Tel: +86 755 8869 6566
Fax: +86 755 8869 6577
Email: customerservice.sw@bureauveritas.com



**BUREAU
VERITAS**

Test Report No.: W7L-P23120015R102

Band2	15MHz	18900	QPSK	6	0	Low	NV	-20	10.03	0.005335	PASS
Band2	15MHz	18900	QPSK	6	0	Low	NV	-10	11.87	0.006314	PASS
Band2	15MHz	18900	QPSK	6	0	Low	NV	0	9.87	0.00525	PASS
Band2	15MHz	18900	QPSK	6	0	Low	NV	10	10.59	0.005633	PASS
Band2	15MHz	18900	QPSK	6	0	Low	NV	20	11.36	0.006043	PASS
Band2	15MHz	18900	QPSK	6	0	Low	NV	40	10.41	0.005537	PASS
Band2	15MHz	18900	QPSK	6	0	Low	NV	60	12.62	0.006713	PASS
Band2	15MHz	18900	QPSK	6	0	Low	NV	70	10.9	0.005798	PASS
Band2	15MHz	18900	QPSK	6	0	Low	NV	-30	11.87	0.006314	PASS
Band2	15MHz	18900	QPSK	6	0	Low	NV	30	11.03	0.005867	PASS
Band2	15MHz	19125	QPSK	6	0	High	NV	0	11.54	0.006066	PASS
Band2	15MHz	19125	QPSK	6	0	High	NV	70	9.34	0.004909	PASS
Band2	15MHz	19125	QPSK	6	0	High	NV	60	11.39	0.005987	PASS
Band2	15MHz	19125	QPSK	6	0	High	NV	50	8.48	0.004457	PASS
Band2	15MHz	19125	QPSK	6	0	High	NV	40	10.61	0.005577	PASS
Band2	15MHz	19125	QPSK	6	0	High	NV	30	9.87	0.005188	PASS
Band2	15MHz	19125	QPSK	6	0	High	NV	10	10.36	0.005445	PASS
Band2	15MHz	19125	QPSK	6	0	High	NV	-10	11.84	0.006223	PASS
Band2	15MHz	19125	QPSK	6	0	High	NV	-20	11.07	0.005819	PASS
Band2	15MHz	19125	QPSK	6	0	High	NV	-30	11.62	0.006108	PASS
Band2	15MHz	19125	QPSK	6	0	High	NV	20	11.33	0.005955	PASS
Band2	15MHz	18675	16QAM	6	0	Low	NV	50	-38.81	-0.020894	PASS
Band2	15MHz	18675	16QAM	6	0	Low	NV	60	-37.57	-0.020226	PASS
Band2	15MHz	18675	16QAM	6	0	Low	NV	40	-39.51	-0.021271	PASS
Band2	15MHz	18675	16QAM	6	0	Low	NV	30	-40.13	-0.021604	PASS
Band2	15MHz	18675	16QAM	6	0	Low	NV	20	-37.04	-0.019941	PASS
Band2	15MHz	18675	16QAM	6	0	Low	NV	10	-40.24	-0.021664	PASS
Band2	15MHz	18675	16QAM	6	0	Low	NV	0	-37.55	-0.020215	PASS

BV 7Layers Communications Technology
(Shenzhen) Co., Ltd

Room B37, Warehouse A5, No.3 Chiwan 4th Road,
Zhaoshang Street, Nanshan District Shenzhen,
Guangdong, People's Republic of China

Tel: +86 755 8869 6566
Fax: +86 755 8869 6577
Email: customerservice.sw@bureauveritas.com



**BUREAU
VERITAS**

Test Report No.: W7L-P23120015R102

Band2	15MHz	18675	16QAM	6	0	Low	NV	-10	-37.42	-0.020145	PASS
Band2	15MHz	18675	16QAM	6	0	Low	NV	-20	-37.06	-0.019952	PASS
Band2	15MHz	18675	16QAM	6	0	Low	NV	-30	-35.65	-0.019192	PASS
Band2	15MHz	18675	16QAM	6	0	Low	NV	70	-37.79	-0.020345	PASS
Band2	15MHz	18900	16QAM	6	0	Low	NV	0	11	0.005851	PASS
Band2	15MHz	18900	16QAM	6	0	Low	NV	-30	12.33	0.006559	PASS
Band2	15MHz	18900	16QAM	6	0	Low	NV	-10	676.42	0.359798	PASS
Band2	15MHz	18900	16QAM	6	0	Low	NV	10	10.4	0.005532	PASS
Band2	15MHz	18900	16QAM	6	0	Low	NV	20	10.81	0.00575	PASS
Band2	15MHz	18900	16QAM	6	0	Low	NV	30	11.87	0.006314	PASS
Band2	15MHz	18900	16QAM	6	0	Low	NV	40	12.07	0.00642	PASS
Band2	15MHz	18900	16QAM	6	0	Low	NV	50	12.43	0.006612	PASS
Band2	15MHz	18900	16QAM	6	0	Low	NV	60	11.24	0.005979	PASS
Band2	15MHz	18900	16QAM	6	0	Low	NV	70	10.81	0.00575	PASS
Band2	15MHz	18900	16QAM	6	0	Low	NV	-20	9.73	0.005176	PASS
Band2	15MHz	19125	16QAM	6	0	High	NV	-20	9.57	0.00503	PASS
Band2	15MHz	19125	16QAM	6	0	High	NV	30	11.33	0.005955	PASS
Band2	15MHz	19125	16QAM	6	0	High	NV	70	9.68	0.005088	PASS
Band2	15MHz	19125	16QAM	6	0	High	NV	60	9.73	0.005114	PASS
Band2	15MHz	19125	16QAM	6	0	High	NV	50	10.33	0.00543	PASS
Band2	15MHz	19125	16QAM	6	0	High	NV	40	11.37	0.005976	PASS
Band2	15MHz	19125	16QAM	6	0	High	NV	20	10.94	0.00575	PASS
Band2	15MHz	19125	16QAM	6	0	High	NV	10	11.04	0.005803	PASS
Band2	15MHz	19125	16QAM	6	0	High	NV	-10	11.24	0.005908	PASS
Band2	15MHz	19125	16QAM	6	0	High	NV	-30	9.63	0.005062	PASS
Band2	15MHz	19125	16QAM	6	0	High	NV	0	9.66	0.005078	PASS
Band2	20MHz	18700	QPSK	6	0	Low	NV	30	-13.65	-0.007339	PASS
Band2	20MHz	18700	QPSK	6	0	Low	NV	70	-12.23	-0.006575	PASS

BV 7Layers Communications Technology
(Shenzhen) Co., Ltd

Room B37, Warehouse A5, No.3 Chiwan 4th Road,
Zhaoshang Street, Nanshan District Shenzhen,
Guangdong, People's Republic of China

Tel: +86 755 8869 6566
Fax: +86 755 8869 6577
Email: customerservice.sw@bureauveritas.com



**BUREAU
VERITAS**

Test Report No.: W7L-P23120015R102

Band2	20MHz	18700	QPSK	6	0	Low	NV	60	-11.74	-0.006312	PASS
Band2	20MHz	18700	QPSK	6	0	Low	NV	50	-11.97	-0.006435	PASS
Band2	20MHz	18700	QPSK	6	0	Low	NV	40	-12.29	-0.006608	PASS
Band2	20MHz	18700	QPSK	6	0	Low	NV	10	-12.35	-0.00664	PASS
Band2	20MHz	18700	QPSK	6	0	Low	NV	0	-8.97	-0.004823	PASS
Band2	20MHz	18700	QPSK	6	0	Low	NV	-10	-12.7	-0.006828	PASS
Band2	20MHz	18700	QPSK	6	0	Low	NV	-20	-10.43	-0.005608	PASS
Band2	20MHz	18700	QPSK	6	0	Low	NV	20	-12.15	-0.006532	PASS
Band2	20MHz	18700	QPSK	6	0	Low	NV	-30	-11.47	-0.006167	PASS
Band2	20MHz	18900	QPSK	6	0	Low	NV	60	10.99	0.005846	PASS
Band2	20MHz	18900	QPSK	6	0	Low	NV	-30	10.5	0.005585	PASS
Band2	20MHz	18900	QPSK	6	0	Low	NV	-20	10.99	0.005846	PASS
Band2	20MHz	18900	QPSK	6	0	Low	NV	-10	10.71	0.005697	PASS
Band2	20MHz	18900	QPSK	6	0	Low	NV	0	10.09	0.005367	PASS
Band2	20MHz	18900	QPSK	6	0	Low	NV	10	11.84	0.006298	PASS
Band2	20MHz	18900	QPSK	6	0	Low	NV	20	10.43	0.005548	PASS
Band2	20MHz	18900	QPSK	6	0	Low	NV	30	11.63	0.006186	PASS
Band2	20MHz	18900	QPSK	6	0	Low	NV	50	11.76	0.006255	PASS
Band2	20MHz	18900	QPSK	6	0	Low	NV	70	12.45	0.006622	PASS
Band2	20MHz	18900	QPSK	6	0	Low	NV	40	11.01	0.005856	PASS
Band2	20MHz	19100	QPSK	6	0	High	NV	70	-6.17	-0.003247	PASS
Band2	20MHz	19100	QPSK	6	0	High	NV	60	8.83	0.004647	PASS
Band2	20MHz	19100	QPSK	6	0	High	NV	50	6.51	0.003426	PASS
Band2	20MHz	19100	QPSK	6	0	High	NV	40	-5.72	-0.003011	PASS
Band2	20MHz	19100	QPSK	6	0	High	NV	30	-6.85	-0.003605	PASS
Band2	20MHz	19100	QPSK	6	0	High	NV	20	-7.31	-0.003847	PASS
Band2	20MHz	19100	QPSK	6	0	High	NV	10	-6.59	-0.003468	PASS
Band2	20MHz	19100	QPSK	6	0	High	NV	0	6.95	0.003658	PASS

BV 7Layers Communications Technology
(Shenzhen) Co., Ltd

Room B37, Warehouse A5, No.3 Chiwan 4th Road,
Zhaoshang Street, Nanshan District Shenzhen,
Guangdong, People's Republic of China

Tel: +86 755 8869 6566
Fax: +86 755 8869 6577
Email: customerservice.sw@bureauveritas.com



**BUREAU
VERITAS**

Test Report No.: W7L-P23120015R102

Band2	20MHz	19100	QPSK	6	0	High	NV	-10	5.98	0.003147	PASS
Band2	20MHz	19100	QPSK	6	0	High	NV	-20	-5.44	-0.002863	PASS
Band2	20MHz	19100	QPSK	6	0	High	NV	-30	-6.67	-0.003511	PASS
Band2	20MHz	18700	16QAM	6	0	Low	NV	0	-10.93	-0.005876	PASS
Band2	20MHz	18700	16QAM	6	0	Low	NV	70	-13.07	-0.007027	PASS
Band2	20MHz	18700	16QAM	6	0	Low	NV	60	-11.36	-0.006108	PASS
Band2	20MHz	18700	16QAM	6	0	Low	NV	50	-10.51	-0.005651	PASS
Band2	20MHz	18700	16QAM	6	0	Low	NV	40	-11.17	-0.006005	PASS
Band2	20MHz	18700	16QAM	6	0	Low	NV	30	-12.47	-0.006704	PASS
Band2	20MHz	18700	16QAM	6	0	Low	NV	10	-11.42	-0.00614	PASS
Band2	20MHz	18700	16QAM	6	0	Low	NV	-10	-12.15	-0.006532	PASS
Band2	20MHz	18700	16QAM	6	0	Low	NV	-20	-11.36	-0.006108	PASS
Band2	20MHz	18700	16QAM	6	0	Low	NV	-30	-11.9	-0.006398	PASS
Band2	20MHz	18700	16QAM	6	0	Low	NV	20	-12.06	-0.006484	PASS
Band2	20MHz	18900	16QAM	6	0	Low	NV	-20	10.69	0.005686	PASS
Band2	20MHz	18900	16QAM	6	0	Low	NV	-30	10.17	0.00541	PASS
Band2	20MHz	18900	16QAM	6	0	Low	NV	-10	11.01	0.005856	PASS
Band2	20MHz	18900	16QAM	6	0	Low	NV	0	10.36	0.005511	PASS
Band2	20MHz	18900	16QAM	6	0	Low	NV	10	11.06	0.005883	PASS
Band2	20MHz	18900	16QAM	6	0	Low	NV	30	11.7	0.006223	PASS
Band2	20MHz	18900	16QAM	6	0	Low	NV	40	10.3	0.005479	PASS
Band2	20MHz	18900	16QAM	6	0	Low	NV	50	15.82	0.008415	PASS
Band2	20MHz	18900	16QAM	6	0	Low	NV	60	10.69	0.005686	PASS
Band2	20MHz	18900	16QAM	6	0	Low	NV	70	11.73	0.006239	PASS
Band2	20MHz	18900	16QAM	6	0	Low	NV	20	10.24	0.005447	PASS
Band2	20MHz	19100	16QAM	6	0	High	NV	-20	-5.74	-0.003021	PASS
Band2	20MHz	19100	16QAM	6	0	High	NV	70	6.25	0.003289	PASS
Band2	20MHz	19100	16QAM	6	0	High	NV	60	-4.99	-0.002626	PASS

BV 7Layers Communications Technology
(Shenzhen) Co., Ltd

Room B37, Warehouse A5, No.3 Chiwan 4th Road,
Zhaoshang Street, Nanshan District Shenzhen,
Guangdong, People's Republic of China

Tel: +86 755 8869 6566
Fax: +86 755 8869 6577
Email: customerservice.sw@bureauveritas.com



**BUREAU
VERITAS**

Test Report No.: W7L-P23120015R102

Band2	20MHz	19100	16QAM	6	0	High	NV	50	6.29	0.003311	PASS
Band2	20MHz	19100	16QAM	6	0	High	NV	40	-6.22	-0.003274	PASS
Band2	20MHz	19100	16QAM	6	0	High	NV	30	-5.65	-0.002974	PASS
Band2	20MHz	19100	16QAM	6	0	High	NV	20	-6.47	-0.003405	PASS
Band2	20MHz	19100	16QAM	6	0	High	NV	10	-5.45	-0.002868	PASS
Band2	20MHz	19100	16QAM	6	0	High	NV	-10	-5.71	-0.003005	PASS
Band2	20MHz	19100	16QAM	6	0	High	NV	-30	-4.56	-0.0024	PASS
Band2	20MHz	19100	16QAM	6	0	High	NV	0	-5.88	-0.003095	PASS

BAND 25 TEST RESULT

Voltage											
Band	Bandwidth	Modulation	Channel	RB Size	RB Start	NB Index	Voltage [Vdc]	Temperature (°C)	Deviation (Hz)	Deviation (ppm)	Verdict
Band25	1.4MHz	26047	QPSK	6	0	Low	VL	NT	-12.27	-0.00663	PASS
Band25	1.4MHz	26047	QPSK	6	0	Low	VH	NT	-12.43	-0.006716	PASS
Band25	1.4MHz	26047	QPSK	6	0	Low	VN	NT	-29.61	-0.015999	PASS
Band25	1.4MHz	26365	QPSK	6	0	Low	VL	NT	-20.67	-0.01098	PASS
Band25	1.4MHz	26365	QPSK	6	0	Low	VH	NT	-12.59	-0.006688	PASS
Band25	1.4MHz	26365	QPSK	6	0	Low	VN	NT	-21.51	-0.011426	PASS
Band25	1.4MHz	26683	QPSK	6	0	High	VH	NT	-12.37	-0.006462	PASS
Band25	1.4MHz	26683	QPSK	6	0	High	VN	NT	-10.97	-0.005731	PASS
Band25	1.4MHz	26683	QPSK	6	0	High	VL	NT	-11.26	-0.005882	PASS
Band25	1.4MHz	26047	16QAM	6	0	Low	VH	NT	-28.85	-0.015589	PASS
Band25	1.4MHz	26047	16QAM	6	0	Low	VL	NT	-25.95	-0.014022	PASS
Band25	1.4MHz	26047	16QAM	6	0	Low	VN	NT	-13.35	-0.007213	PASS
Band25	1.4MHz	26365	16QAM	6	0	Low	VL	NT	-10.24	-0.00544	PASS
Band25	1.4MHz	26365	16QAM	6	0	Low	VH	NT	-25.32	-0.01345	PASS
Band25	1.4MHz	26365	16QAM	6	0	Low	VN	NT	-14.29	-0.007591	PASS
Band25	1.4MHz	26683	16QAM	6	0	High	VH	NT	-11.54	-0.006028	PASS
Band25	1.4MHz	26683	16QAM	6	0	High	VN	NT	-11.36	-0.005934	PASS
Band25	1.4MHz	26683	16QAM	6	0	High	VL	NT	-10.54	-0.005506	PASS
Band25	3MHz	26055	QPSK	6	0	Low	VN	NT	9.94	0.005369	PASS
Band25	3MHz	26055	QPSK	6	0	Low	VL	NT	9.58	0.005174	PASS
Band25	3MHz	26055	QPSK	6	0	Low	VH	NT	11.64	0.006287	PASS
Band25	3MHz	26365	QPSK	6	0	Low	VN	NT	-21.5	-0.011421	PASS
Band25	3MHz	26365	QPSK	6	0	Low	VL	NT	-17.65	-0.009376	PASS
Band25	3MHz	26365	QPSK	6	0	Low	VH	NT	-18.97	-0.010077	PASS

BV 7Layers Communications Technology (Shenzhen) Co., Ltd

Room B37, Warehouse A5, No.3 Chiwan 4th Road, Zhaoshang Street, Nanshan District Shenzhen, Guangdong, People's Republic of China

Tel: +86 755 8869 6566
 Fax: +86 755 8869 6577
 Email: customerservice.sw@bureauveritas.com



BUREAU
VERITAS

Test Report No.: W7L-P23120015R102

Band25	3MHz	26675	QPSK	6	0	High	VN	NT	-15.36	-0.008027	PASS
Band25	3MHz	26675	QPSK	6	0	High	VH	NT	-13.19	-0.006893	PASS
Band25	3MHz	26675	QPSK	6	0	High	VL	NT	-7.68	-0.004014	PASS
Band25	3MHz	26055	16QAM	6	0	Low	VN	NT	10.31	0.005568	PASS
Band25	3MHz	26055	16QAM	6	0	Low	VL	NT	10.93	0.005903	PASS
Band25	3MHz	26055	16QAM	6	0	Low	VH	NT	9.98	0.00539	PASS
Band25	3MHz	26365	16QAM	6	0	Low	VN	NT	-20.08	-0.010667	PASS
Band25	3MHz	26365	16QAM	6	0	Low	VL	NT	-19.86	-0.01055	PASS
Band25	3MHz	26365	16QAM	6	0	Low	VH	NT	-11.43	-0.006072	PASS
Band25	3MHz	26675	16QAM	6	0	High	VN	NT	-6.54	-0.003418	PASS
Band25	3MHz	26675	16QAM	6	0	High	VL	NT	-3.85	-0.002012	PASS
Band25	3MHz	26675	16QAM	6	0	High	VH	NT	-18.28	-0.009553	PASS
Band25	5MHz	26065	QPSK	6	0	Low	VN	NT	-7.37	-0.003978	PASS
Band25	5MHz	26065	QPSK	6	0	Low	VL	NT	-6.78	-0.00366	PASS
Band25	5MHz	26065	QPSK	6	0	Low	VH	NT	-8.5	-0.004588	PASS
Band25	5MHz	26365	QPSK	6	0	Low	VN	NT	-9.54	-0.005068	PASS
Band25	5MHz	26365	QPSK	6	0	Low	VH	NT	-8.87	-0.004712	PASS
Band25	5MHz	26365	QPSK	6	0	Low	VL	NT	-9.93	-0.005275	PASS
Band25	5MHz	26665	QPSK	6	0	High	VN	NT	-11.67	-0.006102	PASS
Band25	5MHz	26665	QPSK	6	0	High	VL	NT	-11.8	-0.00617	PASS
Band25	5MHz	26665	QPSK	6	0	High	VH	NT	-11.46	-0.005992	PASS
Band25	5MHz	26065	16QAM	6	0	Low	VL	NT	-8.33	-0.004497	PASS
Band25	5MHz	26065	16QAM	6	0	Low	VN	NT	-9.57	-0.005166	PASS
Band25	5MHz	26065	16QAM	6	0	Low	VH	NT	-9	-0.004858	PASS
Band25	5MHz	26365	16QAM	6	0	Low	VN	NT	-10.79	-0.005732	PASS
Band25	5MHz	26365	16QAM	6	0	Low	VL	NT	-9.77	-0.00519	PASS
Band25	5MHz	26365	16QAM	6	0	Low	VH	NT	-9.14	-0.004855	PASS
Band25	5MHz	26665	16QAM	6	0	High	VL	NT	-11.62	-0.006076	PASS
Band25	5MHz	26665	16QAM	6	0	High	VN	NT	-11.17	-0.005841	PASS
Band25	5MHz	26665	16QAM	6	0	High	VH	NT	-14.18	-0.007414	PASS
Band25	10MHz	26090	QPSK	6	0	Low	VL	NT	13.56	0.00731	PASS
Band25	10MHz	26090	QPSK	6	0	Low	VH	NT	12.35	0.006658	PASS
Band25	10MHz	26090	QPSK	6	0	Low	VN	NT	12.06	0.006501	PASS
Band25	10MHz	26365	QPSK	6	0	Low	VL	NT	8.28	0.004398	PASS
Band25	10MHz	26365	QPSK	6	0	Low	VH	NT	8.25	0.004382	PASS
Band25	10MHz	26365	QPSK	6	0	Low	VN	NT	8.44	0.004483	PASS
Band25	10MHz	26640	QPSK	6	0	High	VH	NT	17.57	0.009199	PASS
Band25	10MHz	26640	QPSK	6	0	High	VN	NT	15.19	0.007953	PASS
Band25	10MHz	26640	QPSK	6	0	High	VL	NT	17.81	0.009325	PASS
Band25	10MHz	26090	16QAM	6	0	Low	VH	NT	13.03	0.007024	PASS
Band25	10MHz	26090	16QAM	6	0	Low	VL	NT	12.15	0.00655	PASS
Band25	10MHz	26090	16QAM	6	0	Low	VN	NT	12.37	0.006668	PASS
Band25	10MHz	26365	16QAM	6	0	Low	VL	NT	6.81	0.003618	PASS

BV 7Layers Communications Technology
(Shenzhen) Co., Ltd

Room B37, Warehouse A5, No.3 Chiwan 4th Road,
Zhaoshang Street, Nanshan District Shenzhen,
Guangdong, People's Republic of China

Tel: +86 755 8869 6566
Fax: +86 755 8869 6577
Email: customerservice.sw@bureauveritas.com



**BUREAU
VERITAS**

Test Report No.: W7L-P23120015R102

Band25	10MHz	26365	16QAM	6	0	Low	VH	NT	7.61	0.004042	PASS
Band25	10MHz	26365	16QAM	6	0	Low	VN	NT	6.64	0.003527	PASS
Band25	10MHz	26640	16QAM	6	0	High	VH	NT	17.38	0.009099	PASS
Band25	10MHz	26640	16QAM	6	0	High	VN	NT	18.1	0.009476	PASS
Band25	10MHz	26640	16QAM	6	0	High	VL	NT	17.78	0.009309	PASS
Band25	15MHz	26115	QPSK	6	0	Low	VN	NT	9.04	0.004867	PASS
Band25	15MHz	26115	QPSK	6	0	Low	VL	NT	10.5	0.005653	PASS
Band25	15MHz	26115	QPSK	6	0	Low	VH	NT	10.34	0.005567	PASS
Band25	15MHz	26365	QPSK	6	0	Low	VN	NT	-9.67	-0.005137	PASS
Band25	15MHz	26365	QPSK	6	0	Low	VL	NT	-10.46	-0.005556	PASS
Band25	15MHz	26365	QPSK	6	0	Low	VH	NT	-10.76	-0.005716	PASS
Band25	15MHz	26615	QPSK	6	0	High	VN	NT	-7.52	-0.003942	PASS
Band25	15MHz	26615	QPSK	6	0	High	VH	NT	-6.35	-0.003329	PASS
Band25	15MHz	26615	QPSK	6	0	High	VL	NT	-7.61	-0.00399	PASS
Band25	15MHz	26115	16QAM	6	0	Low	VN	NT	10.44	0.00562	PASS
Band25	15MHz	26115	16QAM	6	0	Low	VL	NT	10.83	0.00583	PASS
Band25	15MHz	26115	16QAM	6	0	Low	VH	NT	9.93	0.005346	PASS
Band25	15MHz	26365	16QAM	6	0	Low	VN	NT	-9.81	-0.005211	PASS
Band25	15MHz	26365	16QAM	6	0	Low	VL	NT	-10.14	-0.005386	PASS
Band25	15MHz	26365	16QAM	6	0	Low	VH	NT	-10.99	-0.005838	PASS
Band25	15MHz	26615	16QAM	6	0	High	VN	NT	-5.52	-0.002894	PASS
Band25	15MHz	26615	16QAM	6	0	High	VL	NT	-5.98	-0.003135	PASS
Band25	15MHz	26615	16QAM	6	0	High	VH	NT	-6.78	-0.003554	PASS
Band25	20MHz	26140	QPSK	6	0	Low	VN	NT	-13.53	-0.007274	PASS
Band25	20MHz	26140	QPSK	6	0	Low	VL	NT	-15.68	-0.00843	PASS
Band25	20MHz	26140	QPSK	6	0	Low	VH	NT	-12.33	-0.006629	PASS
Band25	20MHz	26365	QPSK	6	0	Low	VN	NT	-10.53	-0.005594	PASS
Band25	20MHz	26365	QPSK	6	0	Low	VH	NT	-12.99	-0.0069	PASS
Band25	20MHz	26365	QPSK	6	0	Low	VL	NT	-11.03	-0.005859	PASS
Band25	20MHz	26590	QPSK	6	0	High	VN	NT	-10.84	-0.00569	PASS
Band25	20MHz	26590	QPSK	6	0	High	VL	NT	-11.32	-0.005942	PASS
Band25	20MHz	26590	QPSK	6	0	High	VH	NT	-12.22	-0.006415	PASS
Band25	20MHz	26140	16QAM	6	0	Low	VL	NT	-14.62	-0.00786	PASS
Band25	20MHz	26140	16QAM	6	0	Low	VN	NT	-11.92	-0.006409	PASS
Band25	20MHz	26140	16QAM	6	0	Low	VH	NT	-13.38	-0.007194	PASS
Band25	20MHz	26365	16QAM	6	0	Low	VN	NT	-12.46	-0.006619	PASS
Band25	20MHz	26365	16QAM	6	0	Low	VL	NT	-8.63	-0.004584	PASS
Band25	20MHz	26365	16QAM	6	0	Low	VH	NT	-12.06	-0.006406	PASS
Band25	20MHz	26590	16QAM	6	0	High	VH	NT	-12.33	-0.006472	PASS
Band25	20MHz	26590	16QAM	6	0	High	VN	NT	-12.1	-0.006352	PASS
Band25	20MHz	26590	16QAM	6	0	High	VL	NT	-10.87	-0.005706	PASS

BV 7Layers Communications Technology
(Shenzhen) Co., Ltd

Room B37, Warehouse A5, No.3 Chiwan 4th Road,
Zhaoshang Street, Nanshan District Shenzhen,
Guangdong, People's Republic of China

Tel: +86 755 8869 6566
Fax: +86 755 8869 6577
Email: customerservice.sw@bureauveritas.com



Temperature											
Band	Bandwidth	Modulation	Channel	RB Size	RB Start	NB Index	Voltage [Vdc]	Temperature (°C)	Deviation (Hz)	Deviation (ppm)	Verdict
Band25	1.4MHz	26047	QPSK	6	0	Low	NV	70	-12.92	-0.006981	PASS
Band25	1.4MHz	26047	QPSK	6	0	Low	NV	60	-11.24	-0.006073	PASS
Band25	1.4MHz	26047	QPSK	6	0	Low	NV	50	-12.32	-0.006657	PASS
Band25	1.4MHz	26047	QPSK	6	0	Low	NV	40	-27.59	-0.014908	PASS
Band25	1.4MHz	26047	QPSK	6	0	Low	NV	30	-12.45	-0.006727	PASS
Band25	1.4MHz	26047	QPSK	6	0	Low	NV	10	-26.35	-0.014238	PASS
Band25	1.4MHz	26047	QPSK	6	0	Low	NV	0	-14.23	-0.007689	PASS
Band25	1.4MHz	26047	QPSK	6	0	Low	NV	-10	-28.98	-0.015659	PASS
Band25	1.4MHz	26047	QPSK	6	0	Low	NV	-20	-13.52	-0.007305	PASS
Band25	1.4MHz	26047	QPSK	6	0	Low	NV	-30	-14.28	-0.007716	PASS
Band25	1.4MHz	26047	QPSK	6	0	Low	NV	20	-28.48	-0.015389	PASS
Band25	1.4MHz	26365	QPSK	6	0	Low	NV	-30	-24.72	-0.013131	PASS
Band25	1.4MHz	26365	QPSK	6	0	Low	NV	-20	-27.39	-0.01455	PASS
Band25	1.4MHz	26365	QPSK	6	0	Low	NV	-10	-13.86	-0.007363	PASS
Band25	1.4MHz	26365	QPSK	6	0	Low	NV	0	-21.84	-0.011602	PASS
Band25	1.4MHz	26365	QPSK	6	0	Low	NV	10	-13	-0.006906	PASS
Band25	1.4MHz	26365	QPSK	6	0	Low	NV	20	-13.99	-0.007432	PASS
Band25	1.4MHz	26365	QPSK	6	0	Low	NV	30	-24.45	-0.012988	PASS
Band25	1.4MHz	26365	QPSK	6	0	Low	NV	60	-22.62	-0.012016	PASS
Band25	1.4MHz	26365	QPSK	6	0	Low	NV	50	-13.43	-0.007134	PASS
Band25	1.4MHz	26365	QPSK	6	0	Low	NV	40	-23.75	-0.012616	PASS
Band25	1.4MHz	26365	QPSK	6	0	Low	NV	70	-12.82	-0.00681	PASS
Band25	1.4MHz	26683	QPSK	6	0	High	NV	-30	-12.96	-0.00677	PASS
Band25	1.4MHz	26683	QPSK	6	0	High	NV	-20	-13.2	-0.006895	PASS
Band25	1.4MHz	26683	QPSK	6	0	High	NV	-10	-11.32	-0.005913	PASS



**BUREAU
VERITAS**

Test Report No.: W7L-P23120015R102

Band25	1.4MHz	26683	QPSK	6	0	High	NV	0	-10.86	-0.005673	PASS
Band25	1.4MHz	26683	QPSK	6	0	High	NV	10	-11.63	-0.006075	PASS
Band25	1.4MHz	26683	QPSK	6	0	High	NV	20	-9.36	-0.00489	PASS
Band25	1.4MHz	26683	QPSK	6	0	High	NV	30	-9.73	-0.005083	PASS
Band25	1.4MHz	26683	QPSK	6	0	High	NV	40	-10.26	-0.00536	PASS
Band25	1.4MHz	26683	QPSK	6	0	High	NV	50	-11.66	-0.006091	PASS
Band25	1.4MHz	26683	QPSK	6	0	High	NV	60	-12.12	-0.006331	PASS
Band25	1.4MHz	26683	QPSK	6	0	High	NV	70	-12.52	-0.00654	PASS
Band25	1.4MHz	26047	16QAM	6	0	Low	NV	20	-10.97	-0.005927	PASS
Band25	1.4MHz	26047	16QAM	6	0	Low	NV	70	-29.61	-0.015999	PASS
Band25	1.4MHz	26047	16QAM	6	0	Low	NV	60	-13.98	-0.007554	PASS
Band25	1.4MHz	26047	16QAM	6	0	Low	NV	50	-13.72	-0.007413	PASS
Band25	1.4MHz	26047	16QAM	6	0	Low	NV	-30	-27.37	-0.014789	PASS
Band25	1.4MHz	26047	16QAM	6	0	Low	NV	30	-13.2	-0.007132	PASS
Band25	1.4MHz	26047	16QAM	6	0	Low	NV	10	-14.2	-0.007673	PASS
Band25	1.4MHz	26047	16QAM	6	0	Low	NV	0	-28.4	-0.015346	PASS
Band25	1.4MHz	26047	16QAM	6	0	Low	NV	-10	-10.47	-0.005657	PASS
Band25	1.4MHz	26047	16QAM	6	0	Low	NV	-20	-13.75	-0.00743	PASS
Band25	1.4MHz	26047	16QAM	6	0	Low	NV	40	-14.73	-0.007959	PASS
Band25	1.4MHz	26365	16QAM	6	0	Low	NV	50	-26.08	-0.013854	PASS
Band25	1.4MHz	26365	16QAM	6	0	Low	NV	-20	-26.22	-0.013928	PASS
Band25	1.4MHz	26365	16QAM	6	0	Low	NV	70	-23.52	-0.012494	PASS
Band25	1.4MHz	26365	16QAM	6	0	Low	NV	-30	-11.2	-0.00595	PASS
Band25	1.4MHz	26365	16QAM	6	0	Low	NV	-10	-10.23	-0.005434	PASS
Band25	1.4MHz	26365	16QAM	6	0	Low	NV	0	-23.72	-0.0126	PASS
Band25	1.4MHz	26365	16QAM	6	0	Low	NV	10	-22.59	-0.012	PASS
Band25	1.4MHz	26365	16QAM	6	0	Low	NV	20	-13.88	-0.007373	PASS
Band25	1.4MHz	26365	16QAM	6	0	Low	NV	30	-20.76	-0.011028	PASS

BV 7Layers Communications Technology
(Shenzhen) Co., Ltd

Room B37, Warehouse A5, No.3 Chiwan 4th Road,
Zhaoshang Street, Nanshan District Shenzhen,
Guangdong, People's Republic of China

Tel: +86 755 8869 6566
Fax: +86 755 8869 6577
Email: customerservice.sw@bureauveritas.com



**BUREAU
VERITAS**

Test Report No.: W7L-P23120015R102

Band25	1.4MHz	26365	16QAM	6	0	Low	NV	40	-22.07	-0.011724	PASS
Band25	1.4MHz	26365	16QAM	6	0	Low	NV	60	-24.19	-0.01285	PASS
Band25	1.4MHz	26683	16QAM	6	0	High	NV	30	-11.14	-0.005819	PASS
Band25	1.4MHz	26683	16QAM	6	0	High	NV	70	-13.06	-0.006822	PASS
Band25	1.4MHz	26683	16QAM	6	0	High	NV	60	-14.46	-0.007554	PASS
Band25	1.4MHz	26683	16QAM	6	0	High	NV	50	-13.65	-0.007131	PASS
Band25	1.4MHz	26683	16QAM	6	0	High	NV	40	-7.34	-0.003834	PASS
Band25	1.4MHz	26683	16QAM	6	0	High	NV	10	-11.77	-0.006148	PASS
Band25	1.4MHz	26683	16QAM	6	0	High	NV	0	-10.47	-0.005469	PASS
Band25	1.4MHz	26683	16QAM	6	0	High	NV	-10	-10.54	-0.005506	PASS
Band25	1.4MHz	26683	16QAM	6	0	High	NV	-20	-9.44	-0.004931	PASS
Band25	1.4MHz	26683	16QAM	6	0	High	NV	-30	-9.97	-0.005208	PASS
Band25	1.4MHz	26683	16QAM	6	0	High	NV	20	-14.28	-0.00746	PASS
Band25	3MHz	26055	QPSK	6	0	Low	NV	60	7.1	0.003835	PASS
Band25	3MHz	26055	QPSK	6	0	Low	NV	70	9.57	0.005169	PASS
Band25	3MHz	26055	QPSK	6	0	Low	NV	50	9.7	0.005239	PASS
Band25	3MHz	26055	QPSK	6	0	Low	NV	40	10.49	0.005666	PASS
Band25	3MHz	26055	QPSK	6	0	Low	NV	30	10.64	0.005747	PASS
Band25	3MHz	26055	QPSK	6	0	Low	NV	10	7.75	0.004186	PASS
Band25	3MHz	26055	QPSK	6	0	Low	NV	0	8.6	0.004645	PASS
Band25	3MHz	26055	QPSK	6	0	Low	NV	-10	9.74	0.005261	PASS
Band25	3MHz	26055	QPSK	6	0	Low	NV	-20	8.94	0.004829	PASS
Band25	3MHz	26055	QPSK	6	0	Low	NV	-30	9.03	0.004877	PASS
Band25	3MHz	26055	QPSK	6	0	Low	NV	20	10.07	0.005439	PASS
Band25	3MHz	26365	QPSK	6	0	Low	NV	60	-11.6	-0.006162	PASS
Band25	3MHz	26365	QPSK	6	0	Low	NV	-30	-17.72	-0.009413	PASS
Band25	3MHz	26365	QPSK	6	0	Low	NV	-20	-24.09	-0.012797	PASS
Band25	3MHz	26365	QPSK	6	0	Low	NV	-10	-21.97	-0.011671	PASS

BV 7Layers Communications Technology
(Shenzhen) Co., Ltd

Room B37, Warehouse A5, No.3 Chiwan 4th Road,
Zhaoshang Street, Nanshan District Shenzhen,
Guangdong, People's Republic of China

Tel: +86 755 8869 6566
Fax: +86 755 8869 6577
Email: customerservice.sw@bureauveritas.com



BUREAU
VERITAS

Test Report No.: W7L-P23120015R102

Band25	3MHz	26365	QPSK	6	0	Low	NV	0	-11.17	-0.005934	PASS
Band25	3MHz	26365	QPSK	6	0	Low	NV	10	-22.72	-0.012069	PASS
Band25	3MHz	26365	QPSK	6	0	Low	NV	20	-21.09	-0.011203	PASS
Band25	3MHz	26365	QPSK	6	0	Low	NV	30	-18.01	-0.009567	PASS
Band25	3MHz	26365	QPSK	6	0	Low	NV	50	-21.94	-0.011655	PASS
Band25	3MHz	26365	QPSK	6	0	Low	NV	70	-17.4	-0.009243	PASS
Band25	3MHz	26365	QPSK	6	0	Low	NV	40	-18.84	-0.010008	PASS
Band25	3MHz	26675	QPSK	6	0	High	NV	0	-14.33	-0.007489	PASS
Band25	3MHz	26675	QPSK	6	0	High	NV	70	-16.91	-0.008837	PASS
Band25	3MHz	26675	QPSK	6	0	High	NV	60	-6.54	-0.003418	PASS
Band25	3MHz	26675	QPSK	6	0	High	NV	50	-19.63	-0.010259	PASS
Band25	3MHz	26675	QPSK	6	0	High	NV	40	-5.46	-0.002853	PASS
Band25	3MHz	26675	QPSK	6	0	High	NV	30	-7.28	-0.003805	PASS
Band25	3MHz	26675	QPSK	6	0	High	NV	10	-16.57	-0.00866	PASS
Band25	3MHz	26675	QPSK	6	0	High	NV	-10	-5.42	-0.002833	PASS
Band25	3MHz	26675	QPSK	6	0	High	NV	-20	-6.69	-0.003496	PASS
Band25	3MHz	26675	QPSK	6	0	High	NV	-30	-4.96	-0.002592	PASS
Band25	3MHz	26675	QPSK	6	0	High	NV	20	-4.96	-0.002592	PASS
Band25	3MHz	26055	16QAM	6	0	Low	NV	50	11.37	0.006141	PASS
Band25	3MHz	26055	16QAM	6	0	Low	NV	60	10.67	0.005763	PASS
Band25	3MHz	26055	16QAM	6	0	Low	NV	40	9.07	0.004899	PASS
Band25	3MHz	26055	16QAM	6	0	Low	NV	30	9.74	0.005261	PASS
Band25	3MHz	26055	16QAM	6	0	Low	NV	20	9.4	0.005077	PASS
Band25	3MHz	26055	16QAM	6	0	Low	NV	10	7.31	0.003948	PASS
Band25	3MHz	26055	16QAM	6	0	Low	NV	0	5.88	0.003176	PASS
Band25	3MHz	26055	16QAM	6	0	Low	NV	-10	10.76	0.005812	PASS
Band25	3MHz	26055	16QAM	6	0	Low	NV	-20	9.13	0.004931	PASS
Band25	3MHz	26055	16QAM	6	0	Low	NV	-30	6.74	0.00364	PASS

BV 7Layers Communications Technology
(Shenzhen) Co., Ltd

Room B37, Warehouse A5, No.3 Chiwan 4th Road,
Zhaoshang Street, Nanshan District Shenzhen,
Guangdong, People's Republic of China

Tel: +86 755 8869 6566

Fax: +86 755 8869 6577

Email: customerservice.sw@bureauveritas.com



**BUREAU
VERITAS**

Test Report No.: W7L-P23120015R102

Band25	3MHz	26055	16QAM	6	0	Low	NV	70	9.03	0.004877	PASS
Band25	3MHz	26365	16QAM	6	0	Low	NV	0	-21.39	-0.011363	PASS
Band25	3MHz	26365	16QAM	6	0	Low	NV	-30	-10.41	-0.00553	PASS
Band25	3MHz	26365	16QAM	6	0	Low	NV	-10	-23.23	-0.01234	PASS
Band25	3MHz	26365	16QAM	6	0	Low	NV	10	-22.76	-0.01209	PASS
Band25	3MHz	26365	16QAM	6	0	Low	NV	20	-14.26	-0.007575	PASS
Band25	3MHz	26365	16QAM	6	0	Low	NV	30	-20.16	-0.010709	PASS
Band25	3MHz	26365	16QAM	6	0	Low	NV	40	-23.13	-0.012287	PASS
Band25	3MHz	26365	16QAM	6	0	Low	NV	50	-18.91	-0.010045	PASS
Band25	3MHz	26365	16QAM	6	0	Low	NV	60	-23.17	-0.012308	PASS
Band25	3MHz	26365	16QAM	6	0	Low	NV	70	-14.23	-0.007559	PASS
Band25	3MHz	26365	16QAM	6	0	Low	NV	-20	-15.55	-0.00826	PASS
Band25	3MHz	26675	16QAM	6	0	High	NV	-20	-17.75	-0.009276	PASS
Band25	3MHz	26675	16QAM	6	0	High	NV	30	-3.93	-0.002054	PASS
Band25	3MHz	26675	16QAM	6	0	High	NV	70	-6.02	-0.003146	PASS
Band25	3MHz	26675	16QAM	6	0	High	NV	60	-18.64	-0.009741	PASS
Band25	3MHz	26675	16QAM	6	0	High	NV	50	3.43	0.001793	PASS
Band25	3MHz	26675	16QAM	6	0	High	NV	40	-15.51	-0.008106	PASS
Band25	3MHz	26675	16QAM	6	0	High	NV	20	-8.45	-0.004416	PASS
Band25	3MHz	26675	16QAM	6	0	High	NV	10	3.65	0.001907	PASS
Band25	3MHz	26675	16QAM	6	0	High	NV	-10	-6.09	-0.003183	PASS
Band25	3MHz	26675	16QAM	6	0	High	NV	-30	-18.17	-0.009496	PASS
Band25	3MHz	26675	16QAM	6	0	High	NV	0	-15.89	-0.008304	PASS
Band25	5MHz	26065	QPSK	6	0	Low	NV	30	-8.23	-0.004443	PASS
Band25	5MHz	26065	QPSK	6	0	Low	NV	70	-8.71	-0.004702	PASS
Band25	5MHz	26065	QPSK	6	0	Low	NV	60	-8.64	-0.004664	PASS
Band25	5MHz	26065	QPSK	6	0	Low	NV	50	-9.13	-0.004928	PASS
Band25	5MHz	26065	QPSK	6	0	Low	NV	40	-9.47	-0.005112	PASS

BV 7Layers Communications Technology
(Shenzhen) Co., Ltd

Room B37, Warehouse A5, No.3 Chiwan 4th Road,
Zhaoshang Street, Nanshan District Shenzhen,
Guangdong, People's Republic of China

Tel: +86 755 8869 6566
Fax: +86 755 8869 6577
Email: customerservice.sw@bureauveritas.com



**BUREAU
VERITAS**

Test Report No.: W7L-P23120015R102

Band25	5MHz	26065	QPSK	6	0	Low	NV	10	-12.22	-0.006596	PASS
Band25	5MHz	26065	QPSK	6	0	Low	NV	0	-9.9	-0.005344	PASS
Band25	5MHz	26065	QPSK	6	0	Low	NV	-10	-7.97	-0.004302	PASS
Band25	5MHz	26065	QPSK	6	0	Low	NV	-20	-10.23	-0.005522	PASS
Band25	5MHz	26065	QPSK	6	0	Low	NV	20	-8.5	-0.004588	PASS
Band25	5MHz	26065	QPSK	6	0	Low	NV	-30	-9.08	-0.004901	PASS
Band25	5MHz	26365	QPSK	6	0	Low	NV	60	-9.64	-0.005121	PASS
Band25	5MHz	26365	QPSK	6	0	Low	NV	-30	-8.34	-0.00443	PASS
Band25	5MHz	26365	QPSK	6	0	Low	NV	-20	-11.4	-0.006056	PASS
Band25	5MHz	26365	QPSK	6	0	Low	NV	-10	-8.94	-0.004749	PASS
Band25	5MHz	26365	QPSK	6	0	Low	NV	0	-8.75	-0.004648	PASS
Band25	5MHz	26365	QPSK	6	0	Low	NV	10	-10.5	-0.005578	PASS
Band25	5MHz	26365	QPSK	6	0	Low	NV	20	-9.74	-0.005174	PASS
Band25	5MHz	26365	QPSK	6	0	Low	NV	30	-9.48	-0.005036	PASS
Band25	5MHz	26365	QPSK	6	0	Low	NV	50	-9.88	-0.005248	PASS
Band25	5MHz	26365	QPSK	6	0	Low	NV	70	-10.46	-0.005556	PASS
Band25	5MHz	26365	QPSK	6	0	Low	NV	40	-9.9	-0.005259	PASS
Band25	5MHz	26665	QPSK	6	0	High	NV	70	-12.83	-0.006708	PASS
Band25	5MHz	26665	QPSK	6	0	High	NV	60	-10.17	-0.005318	PASS
Band25	5MHz	26665	QPSK	6	0	High	NV	50	-12.29	-0.006426	PASS
Band25	5MHz	26665	QPSK	6	0	High	NV	40	-11.03	-0.005767	PASS
Band25	5MHz	26665	QPSK	6	0	High	NV	30	-12.4	-0.006484	PASS
Band25	5MHz	26665	QPSK	6	0	High	NV	20	-11.72	-0.006128	PASS
Band25	5MHz	26665	QPSK	6	0	High	NV	10	-15.06	-0.007875	PASS
Band25	5MHz	26665	QPSK	6	0	High	NV	0	-12.33	-0.006447	PASS
Band25	5MHz	26665	QPSK	6	0	High	NV	-10	-11.93	-0.006238	PASS
Band25	5MHz	26665	QPSK	6	0	High	NV	-20	-11.3	-0.005908	PASS
Band25	5MHz	26665	QPSK	6	0	High	NV	-30	-13.42	-0.007017	PASS

BV 7Layers Communications Technology
(Shenzhen) Co., Ltd

Room B37, Warehouse A5, No.3 Chiwan 4th Road,
Zhaoshang Street, Nanshan District Shenzhen,
Guangdong, People's Republic of China

Tel: +86 755 8869 6566
Fax: +86 755 8869 6577
Email: customerservice.sw@bureauveritas.com



**BUREAU
VERITAS**

Test Report No.: W7L-P23120015R102

Band25	5MHz	26065	16QAM	6	0	Low	NV	0	-6.81	-0.003676	PASS
Band25	5MHz	26065	16QAM	6	0	Low	NV	70	-11.01	-0.005943	PASS
Band25	5MHz	26065	16QAM	6	0	Low	NV	60	-8.6	-0.004642	PASS
Band25	5MHz	26065	16QAM	6	0	Low	NV	50	-9.84	-0.005312	PASS
Band25	5MHz	26065	16QAM	6	0	Low	NV	40	-7.62	-0.004113	PASS
Band25	5MHz	26065	16QAM	6	0	Low	NV	30	-11.19	-0.00604	PASS
Band25	5MHz	26065	16QAM	6	0	Low	NV	10	-10.53	-0.005684	PASS
Band25	5MHz	26065	16QAM	6	0	Low	NV	-10	-9.87	-0.005328	PASS
Band25	5MHz	26065	16QAM	6	0	Low	NV	-20	-9.13	-0.004928	PASS
Band25	5MHz	26065	16QAM	6	0	Low	NV	-30	-8.85	-0.004777	PASS
Band25	5MHz	26065	16QAM	6	0	Low	NV	20	-6.19	-0.003341	PASS
Band25	5MHz	26365	16QAM	6	0	Low	NV	-20	-9.91	-0.005264	PASS
Band25	5MHz	26365	16QAM	6	0	Low	NV	-30	-9.34	-0.004961	PASS
Band25	5MHz	26365	16QAM	6	0	Low	NV	-10	-8.8	-0.004675	PASS
Band25	5MHz	26365	16QAM	6	0	Low	NV	0	-9.03	-0.004797	PASS
Band25	5MHz	26365	16QAM	6	0	Low	NV	10	-8.24	-0.004377	PASS
Band25	5MHz	26365	16QAM	6	0	Low	NV	30	-10.96	-0.005822	PASS
Band25	5MHz	26365	16QAM	6	0	Low	NV	40	-7.37	-0.003915	PASS
Band25	5MHz	26365	16QAM	6	0	Low	NV	50	-6.31	-0.003352	PASS
Band25	5MHz	26365	16QAM	6	0	Low	NV	60	-8.5	-0.004515	PASS
Band25	5MHz	26365	16QAM	6	0	Low	NV	70	-10.11	-0.005371	PASS
Band25	5MHz	26365	16QAM	6	0	Low	NV	20	-8.94	-0.004749	PASS
Band25	5MHz	26665	16QAM	6	0	High	NV	-20	-13.33	-0.00697	PASS
Band25	5MHz	26665	16QAM	6	0	High	NV	70	-11.66	-0.006097	PASS
Band25	5MHz	26665	16QAM	6	0	High	NV	60	-8.58	-0.004486	PASS
Band25	5MHz	26665	16QAM	6	0	High	NV	50	-13.19	-0.006897	PASS
Band25	5MHz	26665	16QAM	6	0	High	NV	40	-9.2	-0.00481	PASS
Band25	5MHz	26665	16QAM	6	0	High	NV	30	-13.69	-0.007158	PASS

BV 7Layers Communications Technology
(Shenzhen) Co., Ltd

Room B37, Warehouse A5, No.3 Chiwan 4th Road,
Zhaoshang Street, Nanshan District Shenzhen,
Guangdong, People's Republic of China

Tel: +86 755 8869 6566
Fax: +86 755 8869 6577
Email: customerservice.sw@bureauveritas.com



**BUREAU
VERITAS**

Test Report No.: W7L-P23120015R102

Band25	5MHz	26665	16QAM	6	0	High	NV	20	-12.86	-0.006724	PASS
Band25	5MHz	26665	16QAM	6	0	High	NV	10	-11.52	-0.006024	PASS
Band25	5MHz	26665	16QAM	6	0	High	NV	-10	-11.33	-0.005924	PASS
Band25	5MHz	26665	16QAM	6	0	High	NV	-30	-11.29	-0.005903	PASS
Band25	5MHz	26665	16QAM	6	0	High	NV	0	-12.42	-0.006494	PASS
Band25	10MHz	26090	QPSK	6	0	Low	NV	70	13.4	0.007224	PASS
Band25	10MHz	26090	QPSK	6	0	Low	NV	60	11.42	0.006156	PASS
Band25	10MHz	26090	QPSK	6	0	Low	NV	50	9.76	0.005261	PASS
Band25	10MHz	26090	QPSK	6	0	Low	NV	40	11.27	0.006075	PASS
Band25	10MHz	26090	QPSK	6	0	Low	NV	30	13.26	0.007148	PASS
Band25	10MHz	26090	QPSK	6	0	Low	NV	10	11.44	0.006167	PASS
Band25	10MHz	26090	QPSK	6	0	Low	NV	0	12.27	0.006615	PASS
Band25	10MHz	26090	QPSK	6	0	Low	NV	-10	10.66	0.005747	PASS
Band25	10MHz	26090	QPSK	6	0	Low	NV	-20	10.84	0.005844	PASS
Band25	10MHz	26090	QPSK	6	0	Low	NV	-30	9.56	0.005154	PASS
Band25	10MHz	26090	QPSK	6	0	Low	NV	20	12.13	0.006539	PASS
Band25	10MHz	26365	QPSK	6	0	Low	NV	-30	6.47	0.003437	PASS
Band25	10MHz	26365	QPSK	6	0	Low	NV	-20	7.65	0.004064	PASS
Band25	10MHz	26365	QPSK	6	0	Low	NV	-10	5.99	0.003182	PASS
Band25	10MHz	26365	QPSK	6	0	Low	NV	0	7.81	0.004149	PASS
Band25	10MHz	26365	QPSK	6	0	Low	NV	10	4.32	0.002295	PASS
Band25	10MHz	26365	QPSK	6	0	Low	NV	20	7.07	0.003756	PASS
Band25	10MHz	26365	QPSK	6	0	Low	NV	30	7.78	0.004133	PASS
Band25	10MHz	26365	QPSK	6	0	Low	NV	60	8.48	0.004505	PASS
Band25	10MHz	26365	QPSK	6	0	Low	NV	50	5.69	0.003023	PASS
Band25	10MHz	26365	QPSK	6	0	Low	NV	40	6.74	0.00358	PASS
Band25	10MHz	26365	QPSK	6	0	Low	NV	70	7.72	0.004101	PASS
Band25	10MHz	26640	QPSK	6	0	High	NV	-30	15.75	0.008246	PASS

BV 7Layers Communications Technology
(Shenzhen) Co., Ltd

Room B37, Warehouse A5, No.3 Chiwan 4th Road,
Zhaoshang Street, Nanshan District Shenzhen,
Guangdong, People's Republic of China

Tel: +86 755 8869 6566
Fax: +86 755 8869 6577
Email: customerservice.sw@bureauveritas.com



**BUREAU
VERITAS**

Test Report No.: W7L-P23120015R102

Band25	10MHz	26640	QPSK	6	0	High	NV	-20	16.29	0.008529	PASS
Band25	10MHz	26640	QPSK	6	0	High	NV	-10	18.34	0.009602	PASS
Band25	10MHz	26640	QPSK	6	0	High	NV	0	17.09	0.008948	PASS
Band25	10MHz	26640	QPSK	6	0	High	NV	10	18.27	0.009565	PASS
Band25	10MHz	26640	QPSK	6	0	High	NV	20	16.92	0.008859	PASS
Band25	10MHz	26640	QPSK	6	0	High	NV	30	19.67	0.010298	PASS
Band25	10MHz	26640	QPSK	6	0	High	NV	40	19.1	0.01	PASS
Band25	10MHz	26640	QPSK	6	0	High	NV	50	18.38	0.009623	PASS
Band25	10MHz	26640	QPSK	6	0	High	NV	60	17.58	0.009204	PASS
Band25	10MHz	26640	QPSK	6	0	High	NV	70	16.09	0.008424	PASS
Band25	10MHz	26090	16QAM	6	0	Low	NV	20	10.89	0.005871	PASS
Band25	10MHz	26090	16QAM	6	0	Low	NV	70	11.03	0.005946	PASS
Band25	10MHz	26090	16QAM	6	0	Low	NV	60	12.45	0.006712	PASS
Band25	10MHz	26090	16QAM	6	0	Low	NV	50	11.04	0.005951	PASS
Band25	10MHz	26090	16QAM	6	0	Low	NV	-30	10.31	0.005558	PASS
Band25	10MHz	26090	16QAM	6	0	Low	NV	30	12.29	0.006625	PASS
Band25	10MHz	26090	16QAM	6	0	Low	NV	10	12.33	0.006647	PASS
Band25	10MHz	26090	16QAM	6	0	Low	NV	0	11.92	0.006426	PASS
Band25	10MHz	26090	16QAM	6	0	Low	NV	-10	11.94	0.006437	PASS
Band25	10MHz	26090	16QAM	6	0	Low	NV	-20	11.07	0.005968	PASS
Band25	10MHz	26090	16QAM	6	0	Low	NV	40	12	0.006469	PASS
Band25	10MHz	26365	16QAM	6	0	Low	NV	50	8.1	0.004303	PASS
Band25	10MHz	26365	16QAM	6	0	Low	NV	-20	6.94	0.003687	PASS
Band25	10MHz	26365	16QAM	6	0	Low	NV	70	8.08	0.004292	PASS
Band25	10MHz	26365	16QAM	6	0	Low	NV	-30	5.66	0.003007	PASS
Band25	10MHz	26365	16QAM	6	0	Low	NV	-10	6.32	0.003357	PASS
Band25	10MHz	26365	16QAM	6	0	Low	NV	0	6.25	0.00332	PASS
Band25	10MHz	26365	16QAM	6	0	Low	NV	10	6.35	0.003373	PASS

BV 7Layers Communications Technology
(Shenzhen) Co., Ltd

Room B37, Warehouse A5, No.3 Chiwan 4th Road,
Zhaoshang Street, Nanshan District Shenzhen,
Guangdong, People's Republic of China

Tel: +86 755 8869 6566
Fax: +86 755 8869 6577
Email: customerservice.sw@bureauveritas.com



**BUREAU
VERITAS**

Test Report No.: W7L-P23120015R102

Band25	10MHz	26365	16QAM	6	0	Low	NV	20	8.84	0.004696	PASS
Band25	10MHz	26365	16QAM	6	0	Low	NV	30	5.61	0.00298	PASS
Band25	10MHz	26365	16QAM	6	0	Low	NV	40	5.85	0.003108	PASS
Band25	10MHz	26365	16QAM	6	0	Low	NV	60	8.25	0.004382	PASS
Band25	10MHz	26640	16QAM	6	0	High	NV	30	18.42	0.009644	PASS
Band25	10MHz	26640	16QAM	6	0	High	NV	70	17.31	0.009063	PASS
Band25	10MHz	26640	16QAM	6	0	High	NV	60	18.04	0.009445	PASS
Band25	10MHz	26640	16QAM	6	0	High	NV	50	16.84	0.008817	PASS
Band25	10MHz	26640	16QAM	6	0	High	NV	40	18.42	0.009644	PASS
Band25	10MHz	26640	16QAM	6	0	High	NV	10	17.37	0.009094	PASS
Band25	10MHz	26640	16QAM	6	0	High	NV	0	16.44	0.008607	PASS
Band25	10MHz	26640	16QAM	6	0	High	NV	-10	19.08	0.00999	PASS
Band25	10MHz	26640	16QAM	6	0	High	NV	-20	18.83	0.009859	PASS
Band25	10MHz	26640	16QAM	6	0	High	NV	-30	17.81	0.009325	PASS
Band25	10MHz	26640	16QAM	6	0	High	NV	20	17.48	0.009152	PASS
Band25	15MHz	26115	QPSK	6	0	Low	NV	60	12.46	0.006708	PASS
Band25	15MHz	26115	QPSK	6	0	Low	NV	70	10.56	0.005685	PASS
Band25	15MHz	26115	QPSK	6	0	Low	NV	50	12.87	0.006929	PASS
Band25	15MHz	26115	QPSK	6	0	Low	NV	40	10.24	0.005513	PASS
Band25	15MHz	26115	QPSK	6	0	Low	NV	30	9.27	0.004991	PASS
Band25	15MHz	26115	QPSK	6	0	Low	NV	10	10.46	0.005631	PASS
Band25	15MHz	26115	QPSK	6	0	Low	NV	0	11.7	0.006299	PASS
Band25	15MHz	26115	QPSK	6	0	Low	NV	-10	11.3	0.006083	PASS
Band25	15MHz	26115	QPSK	6	0	Low	NV	-20	8.7	0.004684	PASS
Band25	15MHz	26115	QPSK	6	0	Low	NV	-30	10.04	0.005405	PASS
Band25	15MHz	26115	QPSK	6	0	Low	NV	20	12.75	0.006864	PASS
Band25	15MHz	26365	QPSK	6	0	Low	NV	50	-8.38	-0.004452	PASS
Band25	15MHz	26365	QPSK	6	0	Low	NV	-20	-10.19	-0.005413	PASS

BV 7Layers Communications Technology
(Shenzhen) Co., Ltd

Room B37, Warehouse A5, No.3 Chiwan 4th Road,
Zhaoshang Street, Nanshan District Shenzhen,
Guangdong, People's Republic of China

Tel: +86 755 8869 6566
Fax: +86 755 8869 6577
Email: customerservice.sw@bureauveritas.com



**BUREAU
VERITAS**

Test Report No.: W7L-P23120015R102

Band25	15MHz	26365	QPSK	6	0	Low	NV	-10	-11.3	-0.006003	PASS
Band25	15MHz	26365	QPSK	6	0	Low	NV	0	-11.2	-0.00595	PASS
Band25	15MHz	26365	QPSK	6	0	Low	NV	10	-10.66	-0.005663	PASS
Band25	15MHz	26365	QPSK	6	0	Low	NV	20	-7.01	-0.003724	PASS
Band25	15MHz	26365	QPSK	6	0	Low	NV	40	-11.1	-0.005896	PASS
Band25	15MHz	26365	QPSK	6	0	Low	NV	60	-12.03	-0.00639	PASS
Band25	15MHz	26365	QPSK	6	0	Low	NV	70	-9.43	-0.005009	PASS
Band25	15MHz	26365	QPSK	6	0	Low	NV	-30	-11.37	-0.00604	PASS
Band25	15MHz	26365	QPSK	6	0	Low	NV	30	-11.19	-0.005944	PASS
Band25	15MHz	26615	QPSK	6	0	High	NV	0	-6.25	-0.003277	PASS
Band25	15MHz	26615	QPSK	6	0	High	NV	70	-7.58	-0.003974	PASS
Band25	15MHz	26615	QPSK	6	0	High	NV	60	-7.62	-0.003995	PASS
Band25	15MHz	26615	QPSK	6	0	High	NV	50	-8.83	-0.004629	PASS
Band25	15MHz	26615	QPSK	6	0	High	NV	40	-6.47	-0.003392	PASS
Band25	15MHz	26615	QPSK	6	0	High	NV	30	-8.78	-0.004603	PASS
Band25	15MHz	26615	QPSK	6	0	High	NV	10	-7.5	-0.003932	PASS
Band25	15MHz	26615	QPSK	6	0	High	NV	-10	-7.25	-0.003801	PASS
Band25	15MHz	26615	QPSK	6	0	High	NV	-20	-4.62	-0.002422	PASS
Band25	15MHz	26615	QPSK	6	0	High	NV	-30	-6.49	-0.003402	PASS
Band25	15MHz	26615	QPSK	6	0	High	NV	20	-7.6	-0.003984	PASS
Band25	15MHz	26115	16QAM	6	0	Low	NV	50	11.16	0.006008	PASS
Band25	15MHz	26115	16QAM	6	0	Low	NV	60	10.5	0.005653	PASS
Band25	15MHz	26115	16QAM	6	0	Low	NV	40	10.47	0.005637	PASS
Band25	15MHz	26115	16QAM	6	0	Low	NV	30	10.13	0.005454	PASS
Band25	15MHz	26115	16QAM	6	0	Low	NV	20	12.73	0.006853	PASS
Band25	15MHz	26115	16QAM	6	0	Low	NV	10	11.54	0.006213	PASS
Band25	15MHz	26115	16QAM	6	0	Low	NV	0	8.53	0.004592	PASS
Band25	15MHz	26115	16QAM	6	0	Low	NV	-10	10.5	0.005653	PASS

BV 7Layers Communications Technology
(Shenzhen) Co., Ltd

Room B37, Warehouse A5, No.3 Chiwan 4th Road,
Zhaoshang Street, Nanshan District Shenzhen,
Guangdong, People's Republic of China

Tel: +86 755 8869 6566
Fax: +86 755 8869 6577
Email: customerservice.sw@bureauveritas.com



**BUREAU
VERITAS**

Test Report No.: W7L-P23120015R102

Band25	15MHz	26115	16QAM	6	0	Low	NV	-20	10.47	0.005637	PASS
Band25	15MHz	26115	16QAM	6	0	Low	NV	-30	8.88	0.004781	PASS
Band25	15MHz	26115	16QAM	6	0	Low	NV	70	9.77	0.00526	PASS
Band25	15MHz	26365	16QAM	6	0	Low	NV	0	-10.64	-0.005652	PASS
Band25	15MHz	26365	16QAM	6	0	Low	NV	-30	-10.33	-0.005487	PASS
Band25	15MHz	26365	16QAM	6	0	Low	NV	-10	-12.8	-0.006799	PASS
Band25	15MHz	26365	16QAM	6	0	Low	NV	10	-10.23	-0.005434	PASS
Band25	15MHz	26365	16QAM	6	0	Low	NV	20	-10.27	-0.005456	PASS
Band25	15MHz	26365	16QAM	6	0	Low	NV	30	-10.6	-0.005631	PASS
Band25	15MHz	26365	16QAM	6	0	Low	NV	40	-9.54	-0.005068	PASS
Band25	15MHz	26365	16QAM	6	0	Low	NV	50	-10.91	-0.005795	PASS
Band25	15MHz	26365	16QAM	6	0	Low	NV	60	-11.76	-0.006247	PASS
Band25	15MHz	26365	16QAM	6	0	Low	NV	70	-10.69	-0.005679	PASS
Band25	15MHz	26365	16QAM	6	0	Low	NV	-20	-11.82	-0.006279	PASS
Band25	15MHz	26615	16QAM	6	0	High	NV	-20	-9.83	-0.005153	PASS
Band25	15MHz	26615	16QAM	6	0	High	NV	30	-9.74	-0.005106	PASS
Band25	15MHz	26615	16QAM	6	0	High	NV	70	-7.71	-0.004042	PASS
Band25	15MHz	26615	16QAM	6	0	High	NV	60	-6.61	-0.003465	PASS
Band25	15MHz	26615	16QAM	6	0	High	NV	50	-9.21	-0.004828	PASS
Band25	15MHz	26615	16QAM	6	0	High	NV	40	-7.12	-0.003733	PASS
Band25	15MHz	26615	16QAM	6	0	High	NV	20	-7.61	-0.00399	PASS
Band25	15MHz	26615	16QAM	6	0	High	NV	10	-8.14	-0.004267	PASS
Band25	15MHz	26615	16QAM	6	0	High	NV	-10	-8.2	-0.004299	PASS
Band25	15MHz	26615	16QAM	6	0	High	NV	-30	-5.76	-0.00302	PASS
Band25	15MHz	26615	16QAM	6	0	High	NV	0	-5.89	-0.003088	PASS
Band25	20MHz	26140	QPSK	6	0	Low	NV	30	-12.56	-0.006753	PASS
Band25	20MHz	26140	QPSK	6	0	Low	NV	70	-12.13	-0.006522	PASS
Band25	20MHz	26140	QPSK	6	0	Low	NV	60	-11.76	-0.006323	PASS

BV 7Layers Communications Technology
(Shenzhen) Co., Ltd

Room B37, Warehouse A5, No.3 Chiwan 4th Road,
Zhaoshang Street, Nanshan District Shenzhen,
Guangdong, People's Republic of China

Tel: +86 755 8869 6566
Fax: +86 755 8869 6577
Email: customerservice.sw@bureauveritas.com



**BUREAU
VERITAS**

Test Report No.: W7L-P23120015R102

Band25	20MHz	26140	QPSK	6	0	Low	NV	50	-15.71	-0.008446	PASS
Band25	20MHz	26140	QPSK	6	0	Low	NV	40	-10.71	-0.005758	PASS
Band25	20MHz	26140	QPSK	6	0	Low	NV	10	-11.82	-0.006355	PASS
Band25	20MHz	26140	QPSK	6	0	Low	NV	0	-11.67	-0.006274	PASS
Band25	20MHz	26140	QPSK	6	0	Low	NV	-10	-15.16	-0.008151	PASS
Band25	20MHz	26140	QPSK	6	0	Low	NV	-20	-13.38	-0.007194	PASS
Band25	20MHz	26140	QPSK	6	0	Low	NV	20	-14.98	-0.008054	PASS
Band25	20MHz	26140	QPSK	6	0	Low	NV	-30	-13.59	-0.007306	PASS
Band25	20MHz	26365	QPSK	6	0	Low	NV	60	-10.23	-0.005434	PASS
Band25	20MHz	26365	QPSK	6	0	Low	NV	-30	-11.39	-0.00605	PASS
Band25	20MHz	26365	QPSK	6	0	Low	NV	-20	-10.06	-0.005344	PASS
Band25	20MHz	26365	QPSK	6	0	Low	NV	-10	-11.77	-0.006252	PASS
Band25	20MHz	26365	QPSK	6	0	Low	NV	0	-12.7	-0.006746	PASS
Band25	20MHz	26365	QPSK	6	0	Low	NV	10	-14.48	-0.007692	PASS
Band25	20MHz	26365	QPSK	6	0	Low	NV	20	-9.68	-0.005142	PASS
Band25	20MHz	26365	QPSK	6	0	Low	NV	30	-13.1	-0.006959	PASS
Band25	20MHz	26365	QPSK	6	0	Low	NV	50	-9.74	-0.005174	PASS
Band25	20MHz	26365	QPSK	6	0	Low	NV	70	-11.62	-0.006173	PASS
Band25	20MHz	26365	QPSK	6	0	Low	NV	40	-12.72	-0.006757	PASS
Band25	20MHz	26590	QPSK	6	0	High	NV	70	-11.36	-0.005963	PASS
Band25	20MHz	26590	QPSK	6	0	High	NV	60	-11.07	-0.005811	PASS
Band25	20MHz	26590	QPSK	6	0	High	NV	50	-9.6	-0.005039	PASS
Band25	20MHz	26590	QPSK	6	0	High	NV	40	-10.27	-0.005391	PASS
Band25	20MHz	26590	QPSK	6	0	High	NV	30	-8.38	-0.004399	PASS
Band25	20MHz	26590	QPSK	6	0	High	NV	20	-8.8	-0.004619	PASS
Band25	20MHz	26590	QPSK	6	0	High	NV	10	-11.8	-0.006194	PASS
Band25	20MHz	26590	QPSK	6	0	High	NV	0	-10.14	-0.005323	PASS
Band25	20MHz	26590	QPSK	6	0	High	NV	-10	-11.27	-0.005916	PASS

BV 7Layers Communications Technology
(Shenzhen) Co., Ltd

Room B37, Warehouse A5, No.3 Chiwan 4th Road,
Zhaoshang Street, Nanshan District Shenzhen,
Guangdong, People's Republic of China

Tel: +86 755 8869 6566
Fax: +86 755 8869 6577
Email: customerservice.sw@bureauveritas.com



**BUREAU
VERITAS**

Test Report No.: W7L-P23120015R102

Band25	20MHz	26590	QPSK	6	0	High	NV	-20	-10.69	-0.005612	PASS
Band25	20MHz	26590	QPSK	6	0	High	NV	-30	-12.02	-0.00631	PASS
Band25	20MHz	26140	16QAM	6	0	Low	NV	0	-12.97	-0.006973	PASS
Band25	20MHz	26140	16QAM	6	0	Low	NV	70	-10.26	-0.005516	PASS
Band25	20MHz	26140	16QAM	6	0	Low	NV	60	-15.38	-0.008269	PASS
Band25	20MHz	26140	16QAM	6	0	Low	NV	50	-14.05	-0.007554	PASS
Band25	20MHz	26140	16QAM	6	0	Low	NV	40	-14.66	-0.007882	PASS
Band25	20MHz	26140	16QAM	6	0	Low	NV	30	-14.36	-0.00772	PASS
Band25	20MHz	26140	16QAM	6	0	Low	NV	10	-10.39	-0.005586	PASS
Band25	20MHz	26140	16QAM	6	0	Low	NV	-10	-13.03	-0.007005	PASS
Band25	20MHz	26140	16QAM	6	0	Low	NV	-20	-12.36	-0.006645	PASS
Band25	20MHz	26140	16QAM	6	0	Low	NV	-30	-15.32	-0.008237	PASS
Band25	20MHz	26140	16QAM	6	0	Low	NV	20	-11.09	-0.005962	PASS
Band25	20MHz	26365	16QAM	6	0	Low	NV	-20	-11.8	-0.006268	PASS
Band25	20MHz	26365	16QAM	6	0	Low	NV	-30	-11.77	-0.006252	PASS
Band25	20MHz	26365	16QAM	6	0	Low	NV	-10	662.56	0.351958	PASS
Band25	20MHz	26365	16QAM	6	0	Low	NV	0	-12.63	-0.006709	PASS
Band25	20MHz	26365	16QAM	6	0	Low	NV	10	-12.4	-0.006587	PASS
Band25	20MHz	26365	16QAM	6	0	Low	NV	30	-12.6	-0.006693	PASS
Band25	20MHz	26365	16QAM	6	0	Low	NV	40	-12.03	-0.00639	PASS
Band25	20MHz	26365	16QAM	6	0	Low	NV	50	-13.85	-0.007357	PASS
Band25	20MHz	26365	16QAM	6	0	Low	NV	60	-10.97	-0.005827	PASS
Band25	20MHz	26365	16QAM	6	0	Low	NV	70	-12.46	-0.006619	PASS
Band25	20MHz	26365	16QAM	6	0	Low	NV	20	-12.4	-0.006587	PASS
Band25	20MHz	26590	16QAM	6	0	High	NV	-20	-10.24	-0.005375	PASS
Band25	20MHz	26590	16QAM	6	0	High	NV	70	-8.84	-0.00464	PASS
Band25	20MHz	26590	16QAM	6	0	High	NV	60	-9.6	-0.005039	PASS
Band25	20MHz	26590	16QAM	6	0	High	NV	50	-11.1	-0.005827	PASS

BV 7Layers Communications Technology
(Shenzhen) Co., Ltd

Room B37, Warehouse A5, No.3 Chiwan 4th Road,
Zhaoshang Street, Nanshan District Shenzhen,
Guangdong, People's Republic of China

Tel: +86 755 8869 6566
Fax: +86 755 8869 6577
Email: customerservice.sw@bureauveritas.com



**BUREAU
VERITAS**

Test Report No.: W7L-P23120015R102

Band25	20MHz	26590	16QAM	6	0	High	NV	40	-11.62	-0.0061	PASS
Band25	20MHz	26590	16QAM	6	0	High	NV	30	-9.14	-0.004798	PASS
Band25	20MHz	26590	16QAM	6	0	High	NV	20	-12.7	-0.006667	PASS
Band25	20MHz	26590	16QAM	6	0	High	NV	10	-10.77	-0.005654	PASS
Band25	20MHz	26590	16QAM	6	0	High	NV	-10	-10.06	-0.005281	PASS
Band25	20MHz	26590	16QAM	6	0	High	NV	-30	-11.12	-0.005837	PASS
Band25	20MHz	26590	16QAM	6	0	High	NV	0	-9.61	-0.005045	PASS

---END---

DRAFT